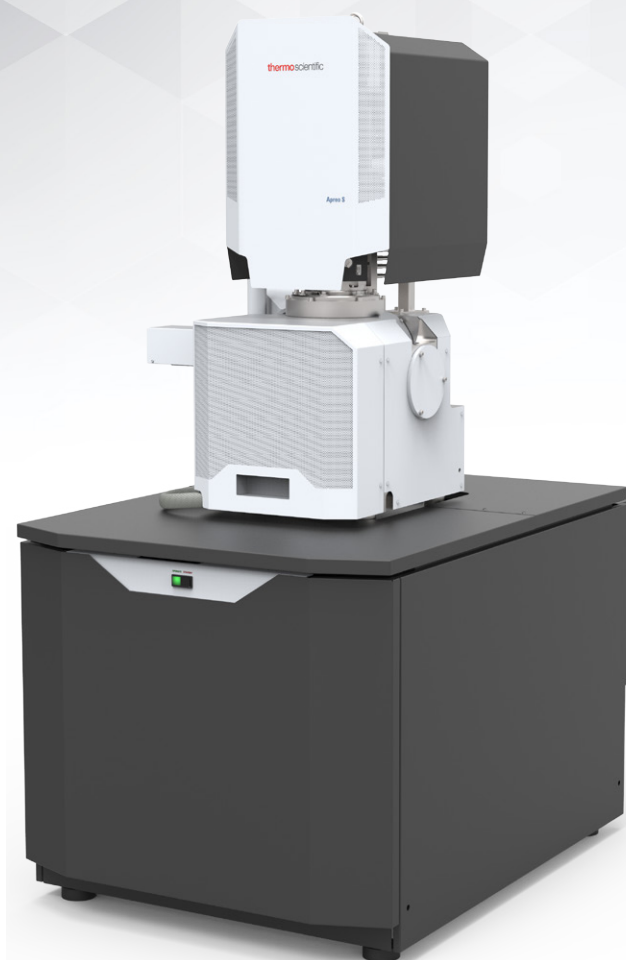


# Apreo User Operation Manual

Revision A  
Mar-2018



## **TRADEMARK ACKNOWLEDGMENTS**

Microsoft® and Windows are registered trademarks of Microsoft Corporation.

This manual was produced using FrameMaker™ document publishing software.  
FrameMaker™ and Adobe are registered trademarks of Adobe Systems Incorporated.

Other product and company names mentioned herein may be trademarks of their respective owners.

## **COPYRIGHT © 2018 BY THERMO FISHER SCIENTIFIC COMPANY**

The information and materials contained herein are confidential and proprietary to Thermo Fisher Scientific Company.

They are provided for your organization's internal use on a need-to-know basis.

They cannot be duplicated or disseminated for any third party without the express consent of  
Thermo Fisher Scientific Company.

## **LIMITED RIGHTS**

Contractor Name:

Thermo Fisher Scientific

Contractor Address:

5350 NE Dawson Creek Drive, Hillsboro, Oregon 97124, USA

The Government's rights to use, modify, reproduce, release, perform, show, or disclose these technical data  
are restricted to those rights specified in:

DFARS 252.227-7015(b)(2), FAR 52.227-14(g)(2) (Alternate II) and FAR 12.211.

Any reproduction of technical data or portions thereof marked with this legend  
must also reproduce the markings.

Any person, other than the Government, who has been provided access to such data,  
must promptly notify the above named Contractor.

## **MANUFACTURER & TECHNICAL SUPPORT**

To provide feedback on this document, please submit via  
<http://www.Thermofisher.com/EM-Sales>

# Table of contents

---

## Chapter 1 System overview

<b>User manuals</b> . . . . .	<b>1-1</b>
Apreo User safety manual . . . . .	1-1
User operation manual . . . . .	1-1
<b>System capabilities</b> . . . . .	<b>1-2</b>
System performance . . . . .	1-2

## Chapter 2 System control

<b>System layout</b> . . . . .	<b>2-1</b>
Other software and hardware . . . . .	2-1
<b>Interface elements</b> . . . . .	<b>2-2</b>
Software . . . . .	2-2
Hardware . . . . .	2-2
Mains switchboard . . . . .	2-3
<b>System states</b> . . . . .	<b>2-5</b>
System startup . . . . .	2-5
Overnight and Standby . . . . .	2-6
System shutdown . . . . .	2-8
<b>Vacuum system</b> . . . . .	<b>2-9</b>
Vacuum status . . . . .	2-10
Vacuum modes . . . . .	2-11
<b>Equipment</b> . . . . .	<b>2-13</b>
Detector types and application . . . . .	2-13
Stages and accessories . . . . .	2-14

## Chapter 3 Software control

<b>Software interface elements</b> . . . . .	<b>3-1</b>
Icons . . . . .	3-1
Tooltips . . . . .	3-1
Pull-down menus . . . . .	3-1
Command buttons . . . . .	3-2
Property editor . . . . .	3-2
Edit boxes . . . . .	3-2
Radio buttons / Check boxes . . . . .	3-2
Adjusters . . . . .	3-3
2D controls . . . . .	3-4
Modules . . . . .	3-4
Dialogs . . . . .	3-4
Tabs . . . . .	3-4
Progress bars . . . . .	3-4
<b>xT microscope Server</b> . . . . .	<b>3-5</b>
<b>Microscope Control</b> . . . . .	<b>3-6</b>
Workspace customization . . . . .	3-6
Menu bar . . . . .	3-9
Toolbar . . . . .	3-23
Imaging area . . . . .	3-27
Status bar . . . . .	3-29
Control pages and modules . . . . .	3-30
<b>Preferences dialog</b> . . . . .	<b>3-38</b>
<b>Account Manager application</b> . . . . .	<b>3-49</b>
Accounts control . . . . .	3-49
User Logins and Account Settings . . . . .	3-51

<b>Entering commands</b> . . . . .	<b>3-52</b>
Using mouse . . . . .	3-52
Using keyboard . . . . .	3-53

## Chapter 4 Alignments

Common Rules . . . . .	4-1
Buttons and Control Elements . . . . .	4-1
Alignments List. . . . .	4-2
<b>Automatic Alignments.</b> . . . . .	<b>4-3</b>
Results. . . . .	4-4
<b>5 - Emitter Startup</b> . . . . .	<b>4-5</b>
<b>Stage Alignments</b> . . . . .	<b>4-6</b>
<b>154 - Water Bottle Venting</b> . . . . .	<b>4-7</b>
<b>Plasma Cleaning / External Plasma Cleaning</b> . . . . .	<b>4-8</b>
<b>Pump Buffer</b> . . . . .	<b>4-9</b>
<b>Vacuum Actions</b> . . . . .	<b>4-10</b>
<b>254 - GIS Alignment (option)</b> . . . . .	<b>4-11</b>
<b>E-Column: Immersion Lens Mode Alignments</b> . . . . .	<b>4-12</b>
<b>E-Column: Lov Vac Alignments.</b> . . . . .	<b>4-13</b>
<b>Magnification Correction</b> . . . . .	<b>4-14</b>
<b>E-Column: Aperture Selection</b> . . . . .	<b>4-15</b>
<b>E-Column: Preventive Maintenance.</b> . . . . .	<b>4-16</b>
<b>E-Column: Supervisor Alignments</b> . . . . .	<b>4-17</b>

## Chapter 5 Operating Procedures

<b>Specimen Preparation and Handling</b> . . . . .	<b>5-2</b>
Needed Items. . . . .	5-2
Natural Specimen . . . . .	5-2
Coated Specimen . . . . .	5-2
Mounting Specimen on Holder . . . . .	5-2
Specimen Baking Unit. . . . .	5-3
<b>Microscope Control</b> . . . . .	<b>5-6</b>
Operation Pre-Check . . . . .	5-6
Inserting / Exchanging Specimen . . . . .	5-7
Selecting Vacuum Mode . . . . .	5-7
Imaging Onscreen . . . . .	5-8
<b>Optimizing Imaging</b> . . . . .	<b>5-9</b>
Principles of SEM Imaging . . . . .	5-9
Magnification. . . . .	5-9
Scan Speed . . . . .	5-10
Contrast & Brightness. . . . .	5-10
Focusing. . . . .	5-11
Correcting Astigmatism . . . . .	5-11
Direct Adjustments . . . . .	5-12
Digital Imaging Enhancement / Imaging Mixing / Coloring . . . . .	5-13
Accelerating Voltage and Beam Currents . . . . .	5-15
Column Use cases . . . . .	5-16
<b>Standard Detectors</b> . . . . .	<b>5-17</b>
Retractable Detectors Control . . . . .	5-17
Infrared CCD Camera . . . . .	5-17
Everhart Thornley Detector (ETD) . . . . .	5-18
Low Vacuum Detector (LVD) . . . . .	5-18
Trinity Detectors T1 / T2 . . . . .	5-19
T1 . . . . .	5-19
T2. . . . .	5-19
T3 (option) . . . . .	5-19
<b>Beam Deceleration</b> . . . . .	<b>5-20</b>



Detection Principles . . . . .	5-20
Beam Deceleration module . . . . .	5-21
Applications . . . . .	5-22
<b>Stage Control . . . . .</b>	<b>5-23</b>
Eucentric Position . . . . .	5-23
Software control . . . . .	5-25
Stage Related Functions . . . . .	5-29
<b>Capturing and Handling Single Image . . . . .</b>	<b>5-36</b>
Image Types . . . . .	5-36
Saving / Opening / Printing . . . . .	5-37
<b>Recording Movies (Saving Multiple Images) . . . . .</b>	<b>5-38</b>
Movie Settings Dialog . . . . .	5-38
Movie Procedure . . . . .	5-40
Movie Creator . . . . .	5-41
<b>Patterns / Measurements / Annotations . . . . .</b>	<b>5-44</b>

## Chapter 6 Maintenance

<b>Cleaning procedures overview . . . . .</b>	<b>6-1</b>
List of applied cleaners . . . . .	6-1
<b>Cleaning column parts . . . . .</b>	<b>6-2</b>
Materials and technique . . . . .	6-2
<b>Cleaning stage mechanics . . . . .</b>	<b>6-2</b>
Cleaning stage parts . . . . .	6-3
<b>Refilling water bottle . . . . .</b>	<b>6-4</b>

## Chapter 7 System Options

<b>Manual User Interface . . . . .</b>	<b>7-2</b>
<b>Joystick . . . . .</b>	<b>7-2</b>
<b>Uninterruptible Power Supply (UPS) . . . . .</b>	<b>7-3</b>
<b>Optional Detectors . . . . .</b>	<b>7-4</b>
Optional detectors connection . . . . .	7-4
Trinity Detector T3 . . . . .	7-4
Directional Gaseous Analytical Detector (GAD) . . . . .	7-5
Directional Backscattered Detector (DBS) -	
Angular Backscattered Detector (ABS)	
Concentric Backscattered Detector (CBS) . . . . .	7-7
Retractable Annular Scanning Transmission Electron Microscopy Detector	
(STEM 3 / STEM 3+) . . . . .	7-8
<b>Nav-Cam . . . . .</b>	<b>7-11</b>
Capturing Navigation Image Procedure . . . . .	7-11
<b>External Current Measurement (Keithley Picoamper Meter) . . . . .</b>	<b>7-12</b>
<b>Energy Dispersive X-ray (EDX) Analysis . . . . .</b>	<b>7-13</b>
High Vacuum . . . . .	7-13
Low Vacuum EDX Analysis . . . . .	7-13
STEM EDX Analysis . . . . .	7-13
<b>Patterning . . . . .</b>	<b>7-14</b>
Patterning Control module . . . . .	7-15
Patterns Processing . . . . .	7-18
Gas Injection module (option) . . . . .	7-20
Application Files . . . . .	7-21
<b>Remote Imaging . . . . .</b>	<b>7-22</b>
Connection to Microscope PC . . . . .	7-22
<b>Quick Loader . . . . .</b>	<b>7-24</b>
Description . . . . .	7-24
Installation . . . . .	7-27
Operations . . . . .	7-28
<b>UMB Stub Holder Kit . . . . .</b>	<b>7-29</b>

<b>CryoCleanerEC</b> . . . . .	<b>7-30</b>
Parts and Accessories . . . . .	7-30
CryoCleaner Operation . . . . .	7-31
Maintenance . . . . .	7-32
Spare Vessel . . . . .	7-32
<b>Plasma Cleaner</b> . . . . .	<b>7-33</b>
Sample Cleaning Procedure . . . . .	7-34
Chamber Cleaning . . . . .	7-34

## User manuals

---

### Apreo User safety manual

---

The safety manual provides information for personal safety and maintenance procedures while operating this system.

This manual is required reading for the end user.



### User operation manual

---

The User Manual is delivered as an electronic PDF file only. However, it is possible to print parts of the manual if this is desired.

We recommend reading the appropriate User Manual section before operating any microscope function. Most importantly, you should locate the topics necessary to operate the microscope in the proper way to safely achieve the best results.

The manual is divided into the following chapters:

1. *System overview* (this chapter)  
gives an overview of the user manual and system capabilities.
2. *System control*  
describes the system hardware (interface elements, vacuum system, system states, equipment).
3. *Software control*  
describes the interface that sets and controls system operation; gives the function of each tool, menu item and control page.
4. *Alignments*  
explains how to align the equipment to achieve the optimal performance.
5. *Operating procedures*  
gives procedures for how to use the system's features.
6. *Maintenance*  
gives allowed step by step cleaning and maintenance procedures.
7. *System options*  
explains relevant options that can be integrated into or added as accessories to the system.

One can take advantage of the search and navigation possibilities within the PDF file. In addition, the following conventions are applied:

- A reference to the specific software element is highlighted in italics. For instance: "Clear the *Stage* menu / *Beam Shift Reset* item."
- Some software functions use shortcuts, which are given beside the heading in brackets. For instance: *Save* (Ctrl + S). They are also given in the *Help* menu / *Keyboard Shortcuts*.

## System capabilities

---

The Apreo is a Scanning Electron Microscope (SEM) that produces enlarged images of a variety of specimens, achieving magnification over 100 000× and provides high resolution imaging in a digital format. The instrument provides optimum throughput, resolution and automation.

This important and widely used analytical tool provides exceptional field of view, requires minimal specimen preparation, and has the ability to combine the technique with X-ray microanalysis.

The instrument provide an expanded range of capabilities:

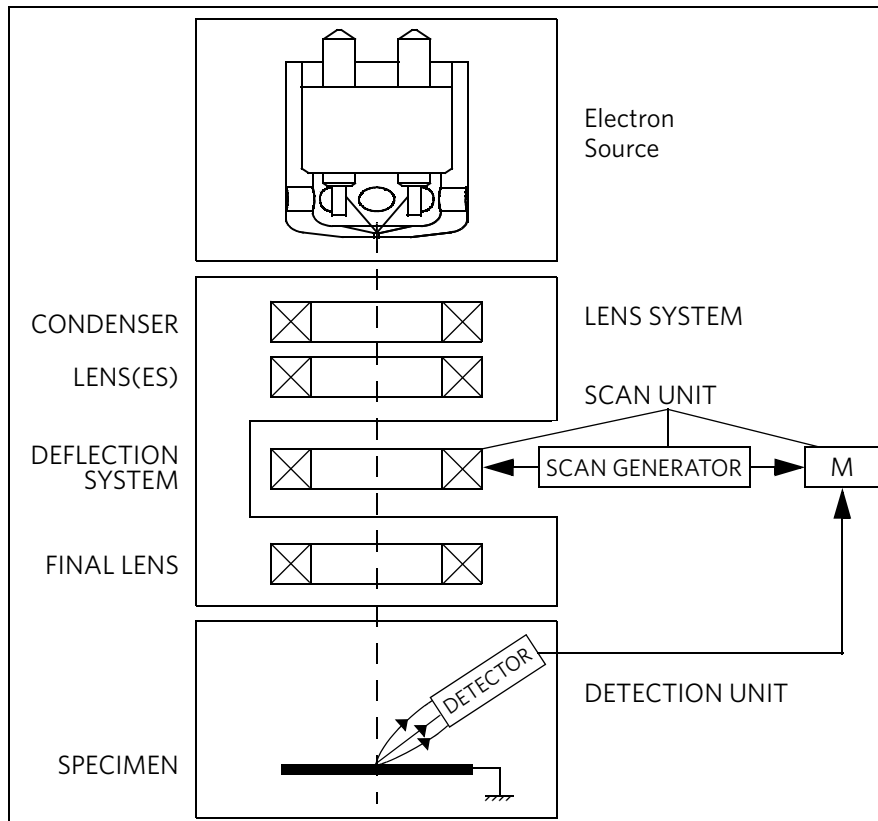
- High-resolution electron beam images
- High resolution elemental microanalysis of defect cross sections
- Imaging of sample surfaces with the electron beam during navigation without erosion

## System performance

---

The main instrument components used for imaging of the samples are:

- *Electron source*  
The beam of electrons (particles) is emitted within a small spatial volume with a small angular spread and selectable energy.
- *Lens system*  
The beam enters the lens system consisting of several electromagnetic or electrostatic lenses and exits to hit the specimen surface.
- *Scan unit*  
The scan generator signal, fed to the deflection systems, moves the beam in a raster pattern over the specimen area. This signal, modulated by the detection system signal, produces the onscreen image of the specimen's surface.
- *Detection unit*  
Particles (electrons) striking the specimen react with atoms of the sample's surface in various manners to produce electrons and photons (X-rays).  
The detector system picks up the particles or photons and converts them into a digital signal that is then sent to the control PC and shown on the monitor.

**FIGURE 1-1:** Column schematic overview

### Computer control

The xT microscope Server and Microscope Control (User Interface) software integrate SEM functionality within a Windows 7 operating environment.

This software consists of programs defining specific instrument settings for particular applications, ensuring reproducibility of complex procedures (for instance imaging, management of image capture, storage, and data output devices etc.). They also control instrument hardware (the column, detector(s), stage, EDX, vacuum functions etc.).

### Vacuum system

The entire particle path from a source to a specimen must be under vacuum so that the particles do not collide with air molecules.

Various levels of vacuum are necessary, so a Turbo Molecular Pump (TMP) backed by a scroll pre-vacuum pump (PVP) obtains the necessary specimen chamber pressure.

#### **High Vacuum (HiVac) mode**

This is the conventional operating mode associated with all scanning electron microscopes.

#### **Low Vacuum (LoVac) mode**

In the gaseous mode the electron column is under lower pressure than the specimen chamber. This mode can use water vapors from a built-in water reservoir, or an auxiliary gas that is supplied by a user and connected to the gas inlet provided for this purpose. Observation of outgassing or highly charging materials can be made using this mode without the need to metal coat the sample, which would be necessary for the conventional HiVac mode.

### Stage

The Apreo has a computer-controlled high-accuracy five-axis stage for small samples. It offers precision specimen computer controlled manipulation and automation of all axes for overall spatial orientation on highly repetitive or extremely irregular samples.

Specimen exchanges take place through a chamber door that exposes the specimen stage when opened or through the Quick Loader (option). An exchange time takes a few minutes; with the Quick Loader, an exchange is much faster. Software and interlocks protect the system against damage and users against an injury.

## Image viewing and capture

Because the amplified detector signal is shown synchronously with the beam scanning, there is a relationship between brightness of an image point on the monitor screen and the signal detected at the corresponding point on the specimen.

Magnification is the ratio of the size of the viewing monitor screen to the size of the area scanned on the specimen. Higher magnification is achieved by reducing the size of the area scanned on the specimen.

## Gas injection system (GIS)

Multiple GIS (option) can be installed for material deposition in conjunction with electron beam pattern definition. Electron beam-induced deposition offers the advantage of not sputtering of the deposited material.

Several GIS chemistries can be installed on the instrument, depending on system configuration. This self-contained apparatus allows the material to be contained entirely within the vacuum system for simple, flexible, and safe operation.

## Analysis capability

Convergence of the SEM and X-ray detection system (e.g. EDX - Energy Dispersive X-ray - option) at a short working distance allows precision chemical analysis at high resolution of surface and subsurface features.

Various vendor options are compatible with the instrument (see Chapter 7).

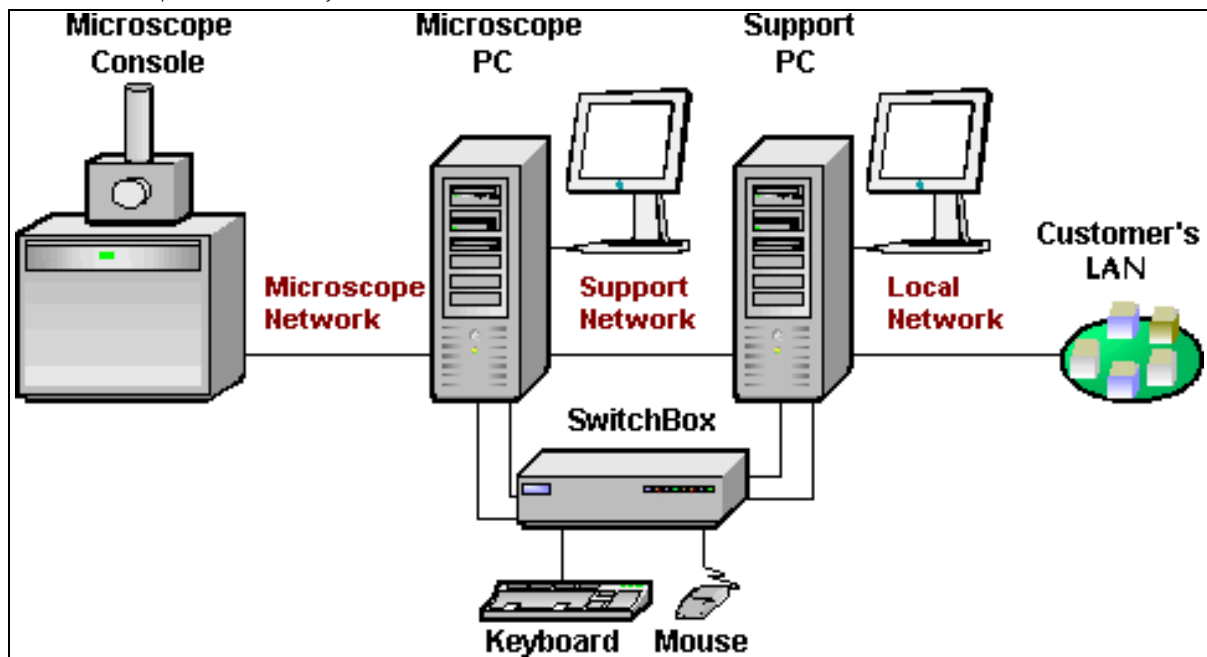


This chapter describes the layout of the system, interface elements and equipment.

## System layout

The basic system layout is based around the dedicated Microscope computer with the LCD monitor and Microscope console. Optionally it is possible to have a second LCD monitor with the Microscope computer or the Support computer, using the LCD monitor and the switch box with keyboard and mouse to switch between the two computers.

**FIGURE 2-1:** Apreo standard layout scheme



### Caution!

*If the equipment is used in a manner not specified by the manufacturer, the protection provided by the equipment may be impaired.*

*Mains power must be connected to a grounded socket that is visible and easily accessible!*

*A user must not disconnect any parts of the equipment or connect any equipment not approved in this manual or in the Apreo User safety manual!*

*All power and external equipment connectors should be covered by stoppers (part of delivery) when not used!*

## Other software and hardware

Call Customer Service for advice before installing software or hardware that is not required for system operation. Other software, such as screen savers or hardware network cards, may corrupt the xT microscope Server / Microscope Control software under some circumstances and may invalidate the warranty.

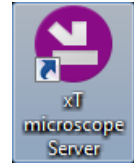
For more detailed information about Windows 7™, refer to the Microsoft® Windows™ User's Guide shipped with your system.

# Interface elements

## Software

The software control contains graphics applications within the Windows 7™ operating environment:

- *xT microscope Server*: starts and stops basic microscope functions
- *Microscope Control (UI – User Interface)*: controls all system functions including imaging, image and movie gathering / manipulation / output, detection and analysis, scanning, magnification, stage navigation, chamber and column pressure, etc.
- *User Management*: ensures users admission to both the operating system, Windows 7, and the Microscope Control software



For information on all the features of these applications see Chapter 3.

## Password policy

After the software installation there are two initial users / passwords common for the OS Windows and the Microscope Control software (UI):

- User: supervisor / Password: supervisor
- User: user / Password: user

The first time logging into the Windows 7 operating system, a user is automatically forced to change his or her password. After that the UI accepts it and enables logging in from that point on.

Each password (either for any new user or after the 90 day period expiration) has to meet the following conditions:

- at least 7 characters long
- the stem must be significantly different from a previous password and shouldn't contain a complete dictionary word or user name
- must contain at least one character from each of these character groups:
  - Uppercase letter
  - Lowercase letter
  - Number
  - Symbol (/ , \* , - , + etc.)

## Hardware

The system is computer-controlled. As such, it has a *Microscope Computer* that must be turned on (use the power button on the PC) to operate the microscope by means of the software. The *support computer* (option) can hold some other software utilities. The *switch box* switches the keyboard and the mouse to either of the two computers. The control software facilities and data are shown graphically on the *LCD monitor* and are superimposed around and on the image. The other LCD monitor is used either as an extended desktop of the Microscope computer or as the Support computer monitor. To control software utilities, one can use a *keyboard*, a *mouse*, the *joystick* (option) or the *Manual User Interface* (option).

## Power button

The console / system power is activated by pressing the power button located on the microscope console front panel. This switches the sub-systems on and allows the interface and communication with the Microscope computer, from which most of the functions are activated via the software control.

The power button indicates several system states:

- *green lit* – the Full Operation state
- *amber lit* – the Standby system state
- *not lit* – the Complete shutdown system state

**FIGURE 2-2:** Control panel Power button





## External connectors panel

The External connectors panel is located on the back of the microscope console.

It is used to connect 3rd party equipment to the following connectors:

### **CONTROL SIGNALS / E-BEAM SCAN INPUT / VIDEO OUT**

These connectors are used for the connection of EDX, WDX and lithography systems, provided by 3rd party suppliers. Do not connect anything else to these connectors!

### **SPECIMEN CURRENT**

This connector is used together with the Keithley picoamper meter (option) equipment.

### **Ground point**

The point is intended for a defined ground connection between a microscope and a 3rd party module. This connection is not a safe ground!

### **ELPHY SCAN & BLANKING IN**

Not used.



## Mains switchboard

### Power off

The system has protection against power failures in the sense that the different components of the system are not likely to be damaged. However, a power failure is never good for the system. It might affect the ultrahigh vacuum levels of the columns and the overall stability of the system.

Take sufficient measures to avoid power failures. If a power failure occurs while the instrument is completely operational, the microscope enters a safe state and the following happens:

- Electron accelerating voltage is switched off.
- Electron emission is switched off.
- The specimen chamber automatically vents gently.

The vacuum in the instrument is no longer supported by running pumps. The column isolating valves close to save the vacuum in the source area.

- The microscope computer and the support computer are switched off. The momentary adjustments of all system parameters (accelerating voltage, magnification, stage positions, etc.) are lost if they were not saved.

### Note

*If mains failures occur occasionally, using the Uninterruptible power supply (UPS - option) is recommended.*

## Emergency off

To switch off the electrical power completely in case of emergency, follow this quick and safe procedure:

1. Push the red *EMERGENCY OFF* (EMO) button (option – see the Apreo User safety manual).

If the button is not installed proceed as follows:

2. Switch off the breaker switch labeled *Main switch S1* at the cabinet back, which is placed at the very left side of the row of three, or disconnect the power cord labeled *Main input 230 VAC*.

**FIGURE 2-3:** *Mains switch board*



If this is not easily accessible:

3. Turn off the mains wall switch (if present), and / or disconnect the mains plug from the mains socket.

## **WARNING!**

*The microscope console water chiller (option – separate device in the microscope vicinity) is powered separately via its individual power cord. Hazardous voltages may be present in this equipment even when the microscope power plug is disconnected!*

## System states

There are several system states:

- *Complete shutdown* – for service and emergency reasons
- *Standby* – for when the system will not be used for a longer period
- *Overnight* – for when the system will not be used overnight
- *Full operation* – when the system working

The Complete shutdown system state can be set only by a supervisor.

See the detailed descriptions of all of the following processes and elements further in this manual.

## System startup

In the *Complete shutdown* state the system is disconnected from all sources used for an operation. Connect the following sources:

- electrical – power cord
- pneumatic – compressed air inlet
- cooling water – hose flanges
- operating gas – nitrogen inlet

The amber color *Power* button on the Microscope console panel starts to shine.

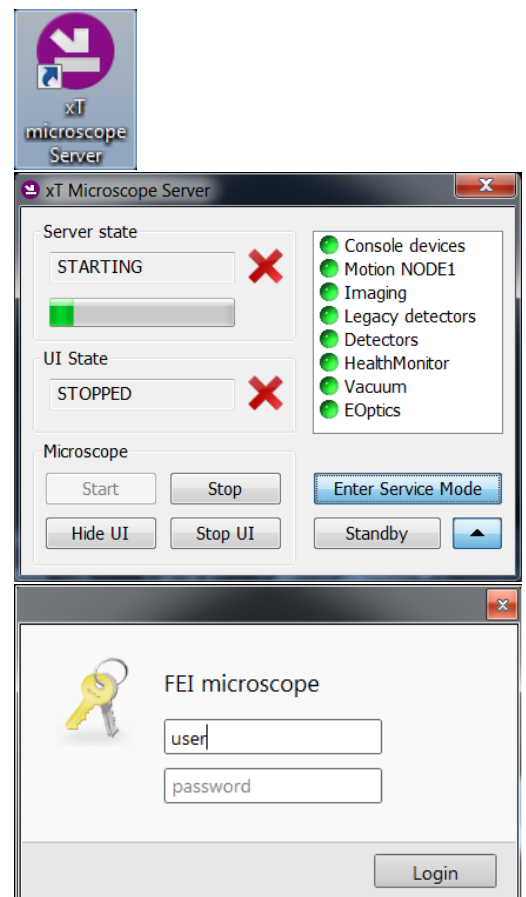
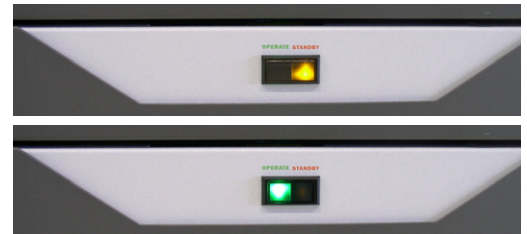
To bring the system to the *Full operation* state, follow this procedure:

1. Push the amber *Power* button on the Microscope console panel – it changes to green <sup>(a)</sup>.
2. Switch on the Microscope computer. The operating system, <sup>(b)</sup> Windows 7™, loads and shows the appropriate icons on the monitor desktop.
3. Double-click the *xT microscope Server* icon to start the software (all visible LED's should be green – Initialized).
4. Click the *Start* button to start the server. Wait until all elements are fully functional (green – Initialized).
5. Click the *Start UI* button to start the *Microscope Control* software. The main window appears behind the *UI Log On* dialog.

### Note

*This step can take place automatically, if the Advanced / Autorun UI check box has been ticked.*

6. Enter your *Username* and *Password* <sup>(b)</sup>.
7. Start the electron column IGP pumps using the *5 - Emitter Startup* alignment – Step 1 of 2. This procedure takes a few minutes and the final *IGP Upper* pressure should be  $< 5 \cdot 10^{-7}$  Pa to start the emitter.
8. Switch on the Emitter using the *5 - Emitter Startup* alignment – Step 2 of 2. This procedure can take about 2 or 40 minutes (short or long procedure), depending on the emitter's conditions. If this is not possible, call service!





9. Select the desired *Vacuum* module / *Vacuum mode* radio button and click on the *Vacuum* module / *Pump* Button. Wait for the *Pumped* status.
10. Click on the *Column* module / *Beam On* button to start the beam. The source awaking progress bar indicates the actual status. The button turns orange when finished.

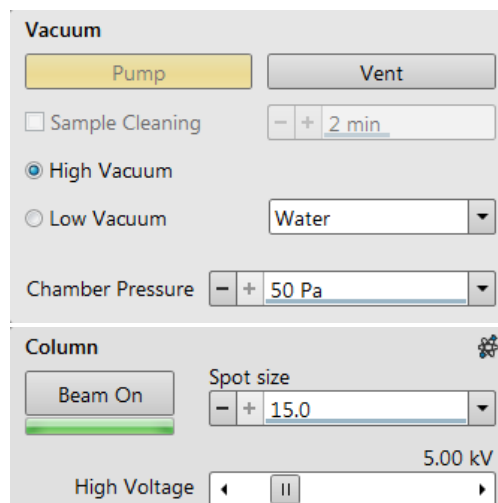
See Chapter 5 to set the desired imaging conditions.

#### Note

*a)* When switching the console on (starting from the Standby state), the SEM aperture becomes heated. It may take several (5 – 10) minutes before it is at the proper temperature. Do not make any adjustments during this interval (aperture, source or lens alignment)! The microscope could become misaligned when the aperture reaches the operational temperature.

*b)* Once you have your microscope user account set up via the User management software or by the account administrator (see Chapter 3), you can use your name and password to access both the Windows 7 system and the Microscope Control software. Take note of the Password policy (see above), which helps protect individual settings and results.

*c)* Usually, the system remains on with the vacuum system in operation, but typically the emitter and accelerating voltage remain off. The system starts with the setting last in use when the Microscope Control software was closed. This allows quick resumption of daily operation.



## Overnight and Standby

In the *Full operation* state all microscope equipment and accessories are in use or are ready to use. When leaving the system, we advise bringing it to the *Overnight* state by following this procedure:

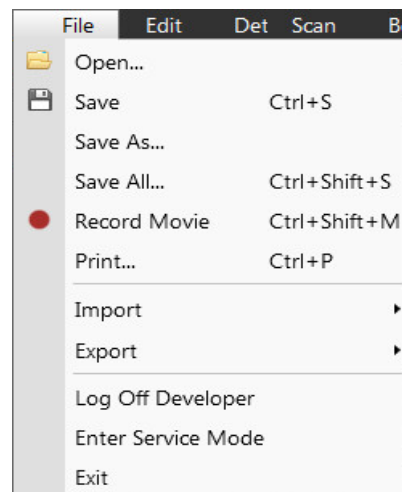
1. Click on the *Column* module / *Beam On* button to switch off the beam.
2. If you need to remove a sample, select the *Stage* menu / *Tilt 0°* (Ctrl + E). Click on the *Vacuum* module / *Vent* button. Wait for the *Vented* status, then remove your sample.
3. Click on the *Vacuum* module / *Pump* button to pump to the High Vacuum. <sup>(d)</sup>

Select <sup>(e)</sup> the *File* menu / *Log Off "present user"*; the *Log On* dialog appears for entering another one. Switch off the monitor.

Now the system is in the *Overnight* state. To proceed to the *Standby* state, follow this procedure:

4. Click on the *xT microscope Server* window / *Standby* button.  
This stops the UI, the xT microscope Server application services and switches off the console (the green power button on the microscope front control panel changes to the amber button).

In the *Standby* state, electron emission remains on, and the chamber vacuum is maintained by running vacuum pumps.



To bring the system back to operation, follow this procedure:

### Caution!

When the Standby state was just entered, wait a minimum of 10 seconds before starting the microscope operation again (by pressing the power button on the microscope front control panel)!

1. Push the amber Power button on the Microscope console panel – it changes to green <sup>(a)</sup>.
2. Double-click on the xT microscope Server icon to start the software (all visible LED's should be green – Initialized).
3. Click on the Start button to start the server. Wait until all elements are fully functional (green – Initialized).
4. Click on the Start UI button to start the Microscope Control software. The main window appears behind the UI Log On dialog.

#### Note

This step can take place automatically, if the Advanced / Autorun UI check box has been ticked.

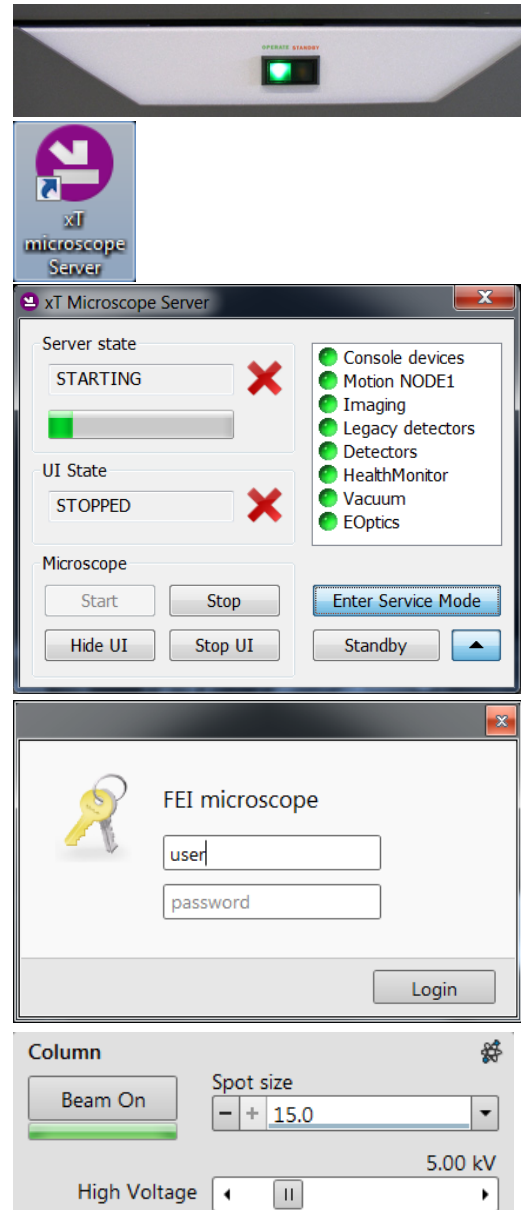
Now the system is in the Overnight state. To proceed to the Full operation state, follow this procedure:

5. Enter your Username and a Password <sup>(b)</sup>.
6. Click on the Column module / Beam On button to start the beam. The source awaking progress bar indicates the actual status and the button turns orange when finished.

#### Note

<sup>d)</sup> We strongly recommend always leaving the chamber evacuated when it is not being used. When the sample chamber is left in the LoVac mode, water vapor is likely to accumulate in it, PVP lifetime decreases, and the water reservoir or gas cylinder empties prematurely.

<sup>e)</sup> Waiting for a new user leaves the status of the Microscope Control software non-operational and only the xT microscope Server software is running. Therefore changing users does not require Logging off / Logging on at the Windows 7™ level.



## System shutdown

In case of emergency, bring the system to the *Complete shutdown* state by following this procedure:

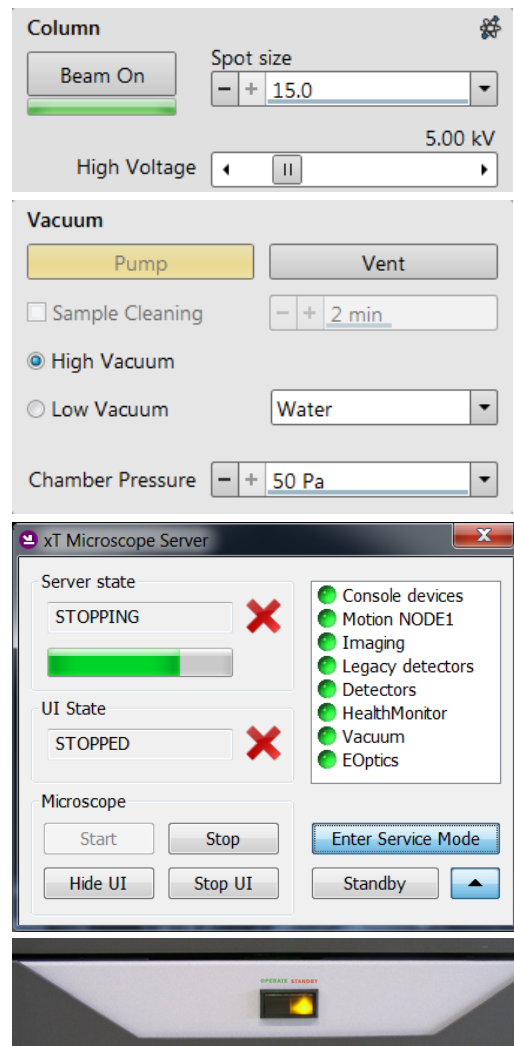
1. Click on the *Column* module / *Beam On* button to stop the accelerating voltage. A *Column* module / *Source* progress bar indicates the actual status; the button turns gray when finished.
2. Click on the *Vacuum* module / *Vent* button to vent the chamber.
3. Switch off the Emitter with the use of the 5 - *Emitter Startup* alignment - Step 2 of 2. <sup>(f)</sup>
4. Click on the *xT microscope Server* software / *Standby* button.  
This stops the UI, the xT microscope Server application services, and the console (the green power button on the microscope front control panel changes to amber). <sup>(g)</sup>
5. Shut down *Windows 7™* and switch off the monitor.
6. If needed, disconnect the power cord and any other input / output used. <sup>(h)</sup>

### Note

<sup>f)</sup> Switching off the console when the Emitter is on is not optimal for the emitter - it may deteriorate its filament lifetime.

<sup>g)</sup> The system can be left in this state if electrical power is supplied to the instrument because the pumps are running and pumping the column.

<sup>h)</sup> The *Complete shutdown* procedure brings the system to the non-powered state, in which the vacuum in the column area is no longer supported by running pumps. All valves are closed, and the electron column and specimen chamber areas are vented. Normally this is used for system transportation or for service actions, such as repair to essential systems (electrical and air supplies).



# Vacuum system

## Model difference

There are the High Vacuum and Low Vacuum variations of the Apreo system. This manual describes the Low Vacuum model. For the High Vacuum model, some controls are missing and functionality is modified accordingly.

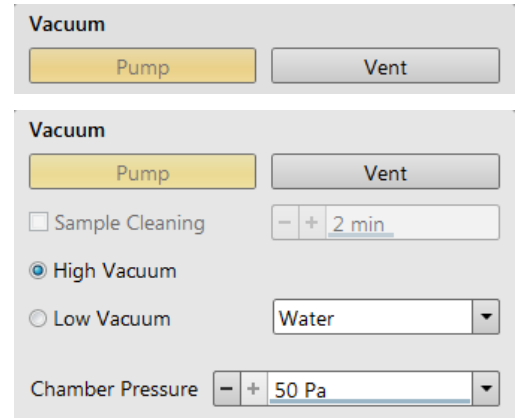
The system has the these vacuum sections:

- Electron source
- Electron column
- Specimen chamber

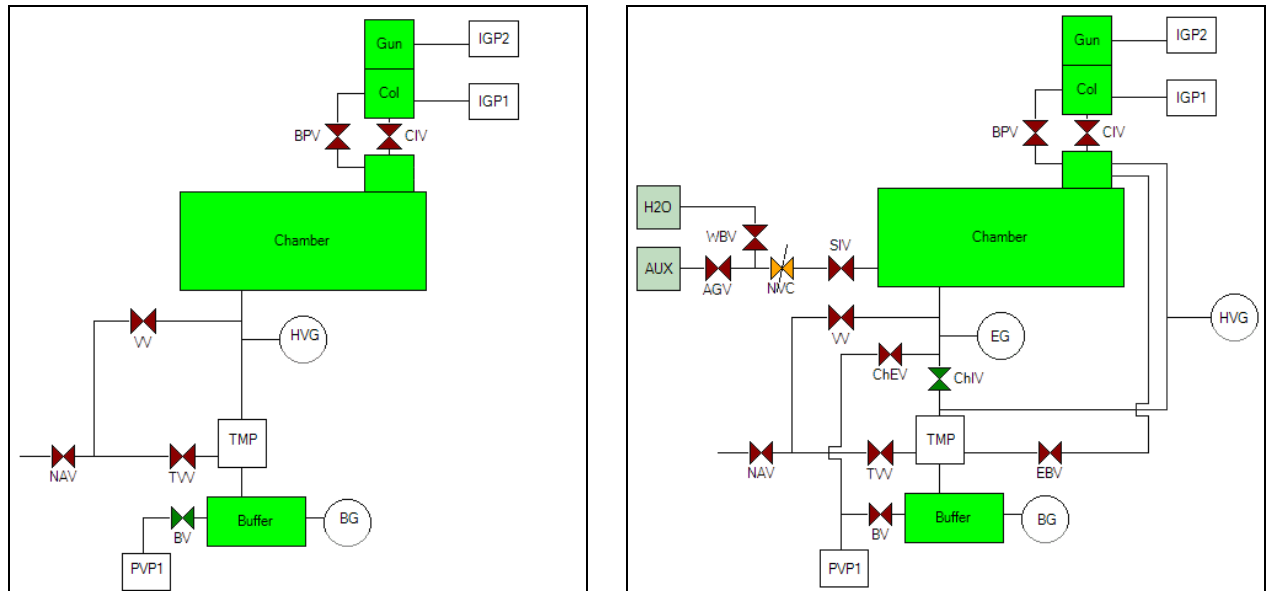
When in operation, the electron source and column section are always under high vacuum. The specimen chamber is at the pressure required for the given state (Pump / Vent) or mode (HiVac / LoVac).

### Note

When the LoVac mode is chosen, the ChIV is closed. All valve and pump operations are fully automatic.



**FIGURE 2-4:** Apreo high vacuum / Apreo low vacuum Vacuum system



- AGV** ..... Auxiliary Gass Valve
- BPV** ..... By Pass Valve
- BG** ..... Buffer Gauge
- BV** ..... Buffer Valve
- CIV** ..... Column Isolation Valve
- ChEV** ..... Chamber Evacuation Valve
- ChIV** ..... Chamber Isolation Valve
- EG** ..... Environment Gauge
- HVG** ..... High Vacuum Gauge

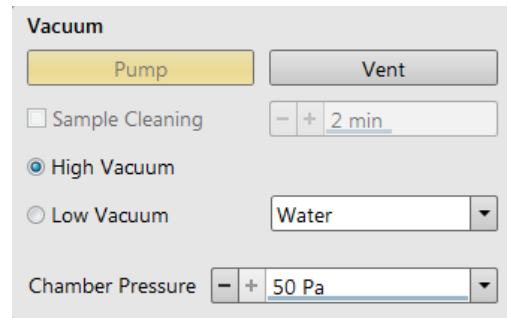
- IGP** ..... Ion Getter Pump
- NAV** ..... Nitrogen Admittance Valve
- NVC** ..... Needle Valve Control
- PVP** ..... Pre Vacuum Pump
- SIV** ..... Servo Isolation Valve
- TMP** ..... Turbo Molecular Pump
- TVV** ..... Turbo Venting Valve
- VV** ..... Venting Valve
- WBV** ..... Water Bottle Valve

## Vacuum status

The vacuum status controls are in the *Vacuum* module. The *Pump* button starts pumping the chamber for the operating pressure and the *Vent* button starts venting the chamber for a sample exchange.

At the bottom right side of the status bar the actual vacuum status is represented by the colored icon, which may have three possible colors with the following meanings:

- *Green*: *PUMPED* to a desired vacuum mode
- *Orange*: *TRANSITION* between vacuum modes (pumping / venting / purging)
- *Gray*: *VENTED* to atmospheric pressure



### Pump button

When the *Pump* button is clicked and the status is *Vented* or when changing the vacuum mode, the system starts to pump. The target pressure depends on the selected vacuum mode. The Pump button is highlighted and is not accessible.

For *High Vacuum*, the system achieves the lowest pressure possible. For *Low Vacuum*, it achieves the pressure specified in the *Vacuum* module / *Chamber Pressure* adjuster. The purge function can be defined in the *Preferences...* dialogue / *Low Vacuum* tab (see Chapter 3).

When the *Pump* button is clicked and the status is *Transition* (venting), the venting procedure stops and the system immediately starts to pump to the actually selected vacuum mode.

### Vent button

When the *Vent* button is clicked and the status is *Pumped*, the confirmation dialog appears. After confirmation, the system switches off the detector voltages, high voltage supplies, vacuum pumps and uses the appropriate valves to vent the system with the use of the dry nitrogen brought to the *Nitrogen Inlet*. Nitrogen is recommended to obtain a better vacuum for high resolution imaging in HiVac mode.

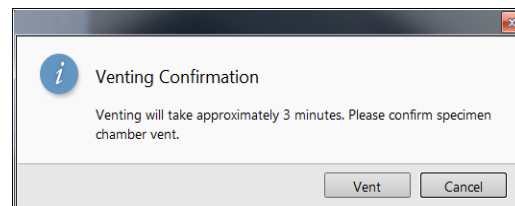
The *Sample Exchange* window and progress bar are shown; the Vent button is highlighted but not accessible. After a specified venting time, the venting valve closes and the vacuum status should indicate *Vented* (see *Preferences...* dialogue / *General* tab / *Venting valve opening time* item). The chamber door can be opened and the button is again enabled.

When the *Vent* button is clicked and the status is *Transition* (pumping), this dialog appears. After confirmation, the pumping procedure stops and the venting procedure starts.

When the *Vent* button is clicked and the status is *Vented*, this dialog appears. After confirmation, the venting valves re-open for the specified venting time and then the valves close.

#### Note

*If you vent the system in order to change a detector, wait until the icon with a gray specimen chamber appears in the Status module. Otherwise there is a risk of a detector assessment malfunction, and as a result, the PLA will not be known by the system.*





## Vacuum modes

The Vacuum module / *High Vacuum* or *Low Vacuum* radio buttons are used to select the instrument target operating mode when a Pump sequence is initiated.

When changing the vacuum mode from one mode to another, a confirmation dialog appears.

### High Vacuum (HiVac) mode

For *High Vacuum*, the system achieves the lowest pressure possible throughout the column and specimen chamber. The typical pressure value is within the order of  $10^{-2}$  to  $10^{-4}$  Pa.

### Low Vacuum (LoVac) mode

In this mode, the column section is under lower pressure than the specimen chamber, where the pressure ranges from 10 to 500 Pa (0.08 to 4.0 Torr) depending on the Use case and PLA used:

- Standard Use case without PLA: 10 - 50 Pa
- OptiPlan Use case with PLA: 10 - 150 Pa
- Standard Use case with PLA: 10 - 500 Pa

This mode uses water vapor from a built-in water reservoir, or a gas from an auxiliary gas inlet (the drop-down list).

When entering the LoVac mode from the vented state or when changing the gas type, chamber pressure goes to the HiVac value and subsequently to the desired LoVac value, so the old gas mixture in the chamber is first exhausted and then replaced by gaseous atmosphere. Entering the HiVac mode can be unwanted for highly outgassing samples (see the *Preferences...* dialogue / *Low Vacuum* section / *Fast Low Vacuum Pumping Through High Vacuum* check box functionality).

The system automatically detects any Low Vacuum detector installed (LVD and GAD) and offers to switch to the LoVac vacuum mode. If a relevant detector is not in place, a warning appears informing the user that the detector should be installed for the mode selected. However, the system will not abort the pump sequence.

## Pressure

The *Chamber Pressure* adjuster is used to set and show the target chamber pressure. Pascal, Torr or Millibar units are available and can be selected in the *Preferences...* dialogue / *Units* tab.

When the system is in LoVac mode and the *Chamber Pressure* value is changed, the pressure automatically changes to the new value. When the system is in any other status and the chamber pressure value is changed, the new value is used as the target pressure when the system starts pumping to a Low Vacuum mode again.

The actual specimen chamber pressure is shown in the *Status bar* / *Chamber Pressure* field.

### PLA (Pressure limiting aperture) Accessories

When the LoVac mode is entered from the HiVac mode or from the Vented status, the system prompts the user with the *PLA Accessories* dialogue.

This only happens the first time after a particular vent procedure.

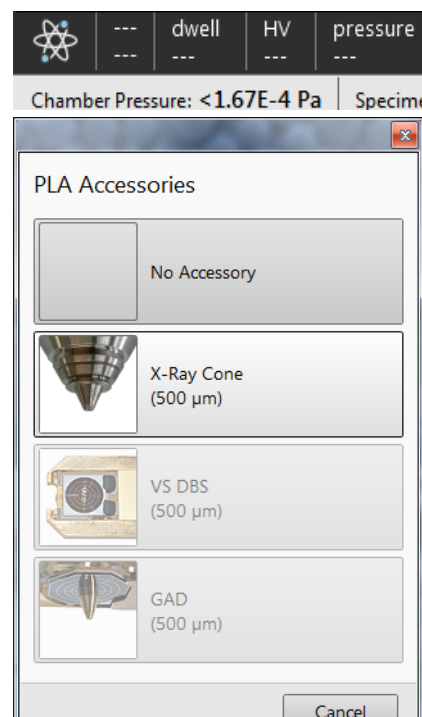
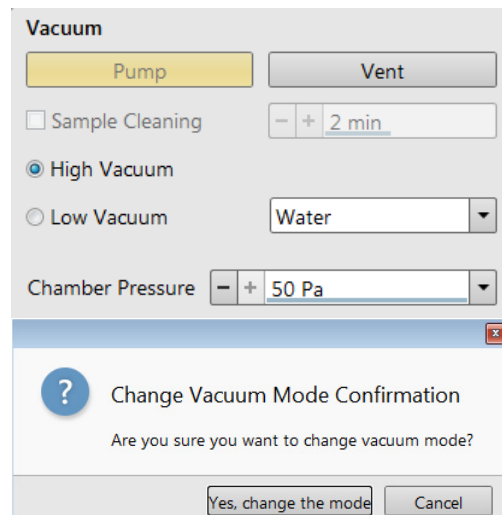
#### Note

*The number and types of accessories within the PLA Accessories dialog vary according to the actual system configuration.*

The maximum allowed specimen chamber pressure in LoVac mode is determined by the size of the PLA cone and the gas type. The *PLA Accessories* dialogue prompts to inform the system about the PLA cone size (part of a dedicated gaseous detector) according to the figure when pumping or switching to LoVac mode. Along with gas type, this information sets pressure limits and rates for pressure changes.

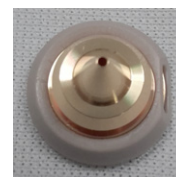
Clicking the appropriate accessory button informs the system that it is mounted on the final lens. The system starts pumping to the LoVac mode. From that point on, this information is automatically used until the system is vented again, when the PLA is set to "unknown". Clicking the *Cancel* button leaves the system in its actual status mode (Pumped or Vented).

The *X-Ray Cone* (500  $\mu$ m aperture) is used for EDX analysis (option) and for the LoVac and low voltage imaging (i.e. below 5 kV) to reduce beam



loss in the gas. For EDX, samples are scanned at a 10 mm working distance, which is the stage eucentric position and the collection point of the EDX detector. The cone height is 5.5 mm and restricts the field of view. See Chapter 5 for the cone mounting procedure.

The longer profile of this cone minimizes low voltage beam dispersion and skirting of the primary beam in the gaseous environment of the chamber, allowing more electrons to interact with the specimen when focused and increasing the signal to noise ratio.



**Note**

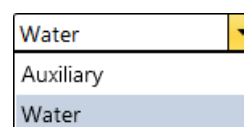
The PLA also acts as a final or objective aperture, so the pressure over it is considered very low. Any pollution that accumulates on the aperture edge greatly affects imaging. If it is not possible to correct astigmatism, it is usually a sign that this aperture needs to be cleaned or replaced (see Chapter 6).

**Warning!**

Applying a cone or a detector with an integrated cone scales down the space between the top sample surface and the cone (at the particular working distance) by the value equivalent to the cone height.

**Using gas**

The Low Vacuum mode allows a user to image samples in a gaseous atmosphere, which can be selected in the drop down list box:



- Auxiliary (option) gaseous environment, which is supplied via the inlet placed on the back of the console.
- Water vapor is supplied from a built-in water reservoir located on the left side of the microscope console.

**Note**

On occasion the water reservoir needs to be filled (see Chapter 6).

**Caution!**

Maximum overpressure for the Auxiliary gas and Nitrogen inlets is 10 kPa (0.1 bar). The Nitrogen inlet is used only for venting the chamber with air, or preferably with nitrogen.

When using a particular pressure limiting aperture, there are pressure limits for different gasses.

**Table 2-1:** Maximal Chamber Pressure [Pa (Torr)] under Different Gaseous Environment

Working Gas	Maximum Chamber Pressure [Pa] (Torr)
Water - H <sub>2</sub> O	50 (0.4)
Nitrogen - N <sub>2</sub>	
Air	
Carbon Dioxide - CO <sub>2</sub>	
Nitrogen Dioxide - NO <sub>2</sub>	
Helium - He	25 (0.2)
70 % He + 30 % H <sub>2</sub>	20 (0.15)
Argon - Ar <sup>**)</sup>	16 (0.1)
C <sub>x</sub> H <sub>y</sub> <sup>*)</sup>	50 (0.4)

**Caution!**

The system doesn't watch the limits, and higher overpressure (especially for gasses not listed) set by a user could switch off the emitter! In some cases, the system would need to be restarted by a service engineer.

**Note**

\*) Combustible gases (acetylene for instance) must always be used with respect to safety issues.

\*\*) Argon use should be minimized to a short time, because the IGP's are not at all optimized for pumping it.

**Purging**

During this procedure the specimen chamber is automatically pumped down to a lower pressure to remove the old gas and is then is flooded with the new gas (selected in the Vacuum module) to a higher pressure. This takes place several times, until the old gas is removed and the chamber is mostly filled with the new gas. This is applied when the system is in the LoVac mode and the Purge button is pressed (see the Preferences... dialogue / Low Vacuum section). The procedure is also started automatically with factory presets in these situations:

- when the LoVac mode has not been used for 1 week or more;
- after water bottle venting when refilling the water level (see Chapter 6).

**Note**

The automatic procedure can take a while (up to 10 minutes). Wait until the Vacuum status indicates Pumped, because the detectors do not start operation until desired pressure is reached.

# Equipment

## Detector types and application

There are several either standard or optional system detectors. The *Detectors* menu shows all installed detectors. The accessibility / inaccessibility of detectors (black / gray label) depends on actual system conditions.

**Note**

*For settings and handling of particular standard / optional detectors, see Chapters 5 and 7.*

Detectors	Scan
ETD (SE)	
✓ T1 (A+B)	
T2 (A+B)	
T3 (Scint)	
ABS (All)	
CBS (All)	

**Table 2-2:** Apreo detectors list

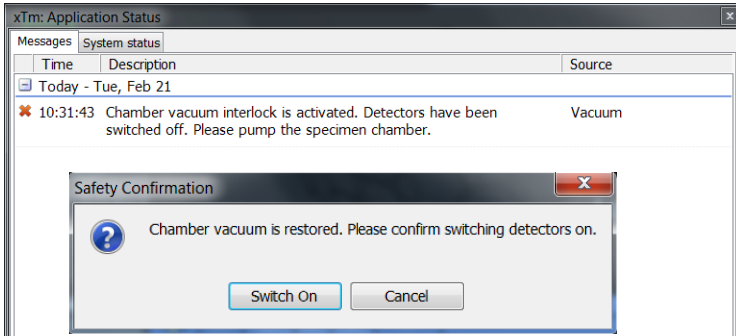
Detector name	Tag	Vacuum mode	Detected signal	Note
Everhart-Thornley	ETD	HiVac	SE (tunable energy) / BSE	S
T1	T1	HiVac / LoVac	SE (for OptiPlan and Immersion Use cases)	S
T2	T2	HiVac / LoVac	SE (for OptiPlan and Immersion Use cases)	S
Low Vacuum	LVD	LoVac	SE	S
CCD camera	CCD		light, infra-red light	S
External	EXT		detector-dependent	
T3	T3	HiVac	SE (for OptiPlan and Immersion Use cases)	O
RGB Cathodeluminescence	CLD	HiVac / LoVac	Light	O
Directional Gaseous Analytical	GAD-ABS / GAD-CBS	LoVac	BSE	O, LM
Directional Backscattered (DBS)	ABS / CBS	HiVac / LoVac	BSE	O, LM
Retractable Directional Backscattered (DBS)	ABS / CBS	HiVac	BSE	O
Retractable Annular STEM	STEM 3 STEM 3+	HiVac	TE	O

SE = secondary electrons, BSE = back scattered electrons, TE = transmitted electrons,  
S = standard, O = optional, LM = lens mounted version

**Note**

*In case the vacuum safety interlock is activated, it is necessary to confirm switching the detector voltage on after pumping the system.*

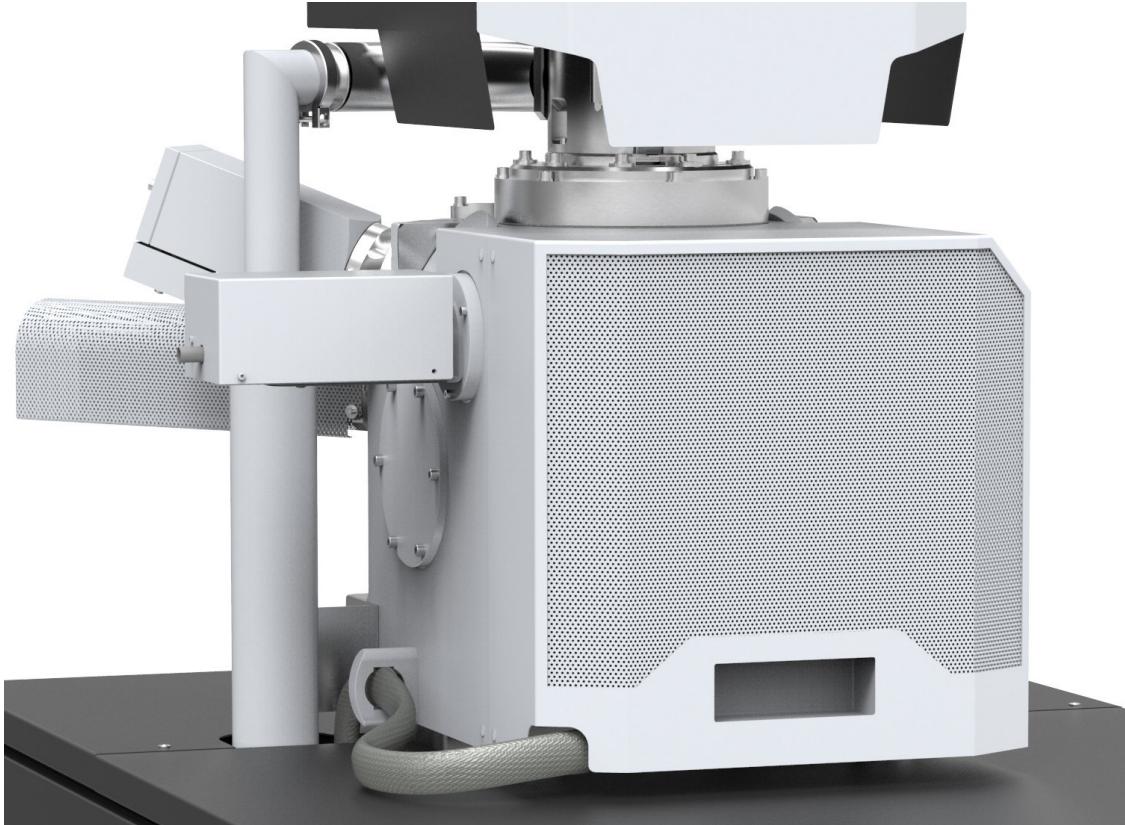
**FIGURE 2-5:** *Safety interlock message*



## Stages and accessories

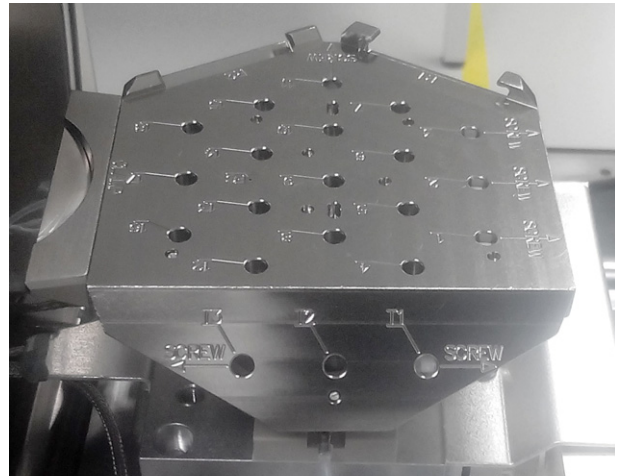
The chamber is equipped with an 110 × 110 mm stage, that can be oriented with reference to five axes: *X*, *Y*, *Z*, *Rotation* and *Tilt*. All movements are motorized and software controlled (an integrated part of the *Microscope Control* software). Stage positions are shown on the screen.

**FIGURE 2-6:** 110 × 110 mm chamber



### Multipurpose stub holder

The holder contains 18 horizontal and three pre-tilted positions for 12.5 mm stubs. Horizontal and pre-tilted positions for the STEM row holder are also included, together with a sample clamp and a Faraday clamp. All positions are marked for easier navigation. Stubs can be mounted to most of the positions without any tools.



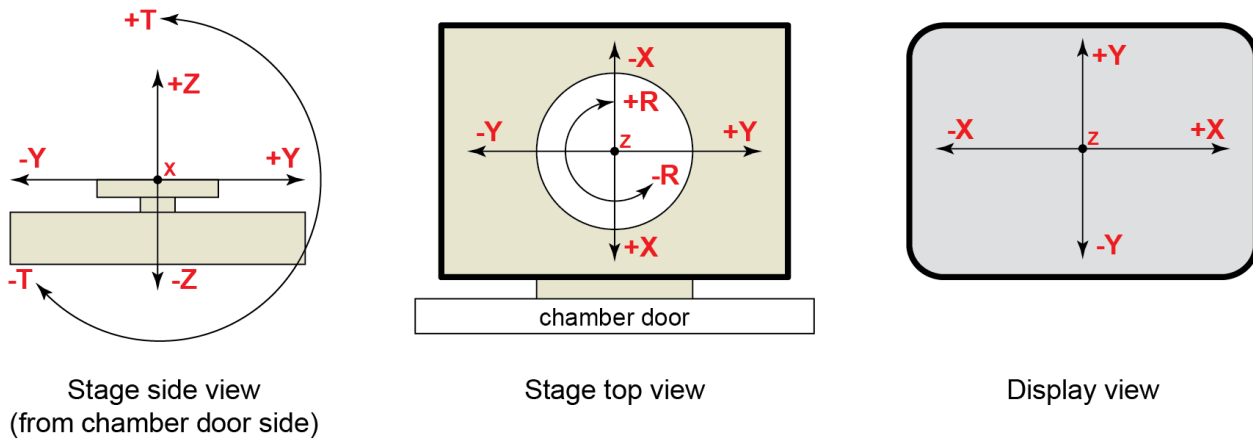
### Stage movement limits

The motorized movements of the stage can be operated under software control for more advanced location mapping. This includes *Shift*, *Get*, *Track* and *Stage* module functionality. A live image can be repositioned either by the stage movement or by the *Beam Shift*.

**Note**

When moving the stage or tilting the specimen, the magnification may need to be reduced so as to not lose the feature of interest from the screen.

**FIGURE 2-7:** Stage movement schema



**Table 2-3:** Stage features and limits

Item	110 × 110 mm	Note
<b>X</b>	-55 to +55 mm	
<b>Y</b>	-55 to +55 mm	
<b>Z</b>	66 mm	
<b>R</b>	360°	continuous
<b>T</b>	-15° to +90°	maximally
<b>Eucentric distance</b>	10 mm	
<b>Maximum sample weight</b>	No restriction: 500 g	including stub holder
	No Tilt: 2 000 g	
	X and Y movements only: 5 000 g	

**Caution!**

The positive Z value direction depends on the Link Z to FWD status (see Chapter 5).

**Caution!**

If the maximum sample size is near the limit, stage tilt can be limited. Beware of hitting the objective pole piece!

This chapter describes the functionality of each part of the user software interface within the Windows 7™ operating system:

- *xT microscope Server*
- *Microscope Control (UI - User Interface)*
- *User Management*

## Software interface elements

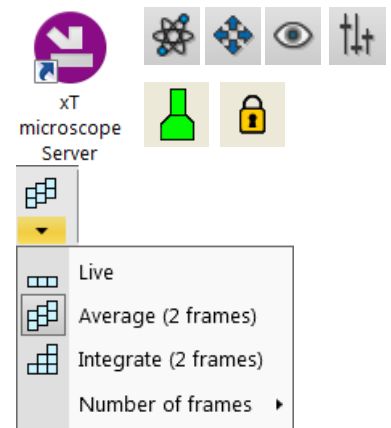
### Icons

*Icons* are small symbols indicating a specific software application. Double-click on an icon located on the desktop or within a folder to activate its program.

There are also *function icons* in the toolbar for selecting some software functions quickly. Clicking on a function icon causes it to be highlighted and activated. Clicking on it again or clicking on another one (depending on the particular case) causes it to become normal and deactivated.

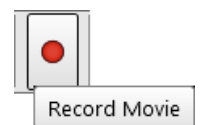
Some function icons have an additional down arrow. Clicking on that arrow reveals a pull-down menu with choices, while clicking on the icon performs a particular function (cyclic changeover of choices, setting the default parameters, etc.).

There are also some *informational icons* in the status bar, such as those that indicate a particular system status.



### Tooltips

The Tooltips functionality activates when the cursor is left over an item on the user interface for more than two seconds. A short explanation of the item appears until the cursor is moved away from it.



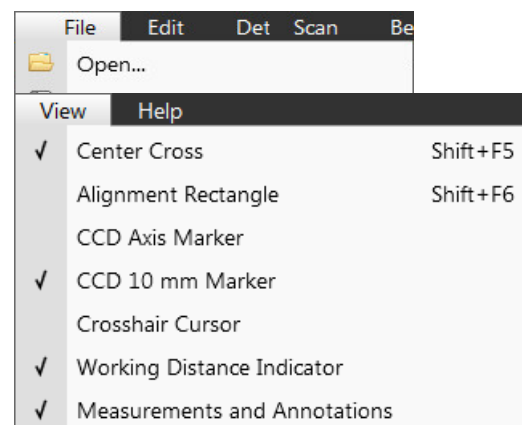
### Pull-down menus

The microscope uses menu-oriented software; you perform functions by choosing items from the *Menu bar*. The Menu bar contains pull-down menus that show grouped listings of available commands or settings. Some menu items are shown in gray and are not accessible because of the system's immediate condition.

Pull-down menu items followed by an ellipsis (...) indicate that this is a command and a dialog box will show. A right arrow on the right side indicates that an additional submenu of choices will show. If an item is a parameter value, the new value is updated immediately and a check mark appears in the pull-down menu.

#### Context menus

Right-click on some items to call out a context menu with other corresponding choices.





## Using the mouse

Click on / right-click on / wheel-click on represents clicking with the left / right / wheel mouse button on an item throughout this manual. The click on & drag / right-click on & drag / wheel-click on & drag means holding the mouse button during a dragging action.

Click on & drag the cursor down the menu to a desired item and then release the mouse button.

## Using the keyboard

Press Alt + the underlined letter (for example, *Alt + F* for the File menu), and then select from the choices by clicking on one of them or by hitting the *Enter* button after selecting one with the up / down (left / right for submenus) arrow keys.

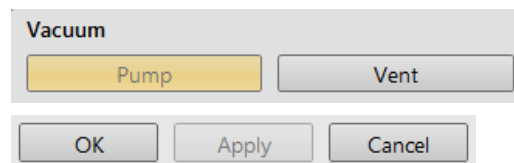
Some often-used commands can be quickly activated with the use of shortcut keys (a combination of simultaneously pressed keys) at any time. This possibility is given by a particular button combination on the right side of the pull-down menu adjacent to the appropriate command (see *Help* menu / *Keyboard Shortcuts*).

## Command buttons

Command buttons carry out or cancel functions. They activate when clicked and some are highlighted (orange background) to show corresponding function activity.

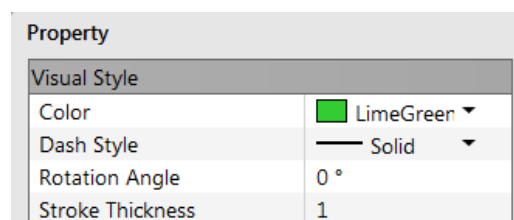
Command buttons have labels that describe the actions performed by clicking on them. The most common ones, which are typically used in dialogs, are:

- *OK* button - applies all changes made in the dialog and closes it.
- *Finish* button - saves new settings, ends the procedure and closes the dialog.
- *Save* button - saves new settings at that point without closing the dialog.
- *Apply* button - saves and applies new settings at that point without closing the dialog.
- *Cancel* button - discards all changes (made from the last save) and closes the dialog. It has the same effect as closing the dialog by clicking the red cross (Alt + F4).
- *Next* button - moves a user to the next dialog after necessary settings have been performed.
- *Previous* button - moves a user to the previous dialog when settings need to be changed.



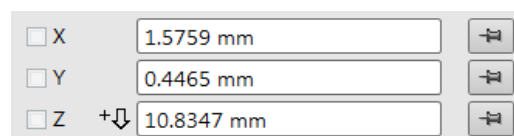
## Property editor

The Property editor is the list of related parameters and their values. A user should click on in the *Value* side of the relevant property *Name* and then select its value from the drop down list or enter it using a keyboard.



## Edit boxes

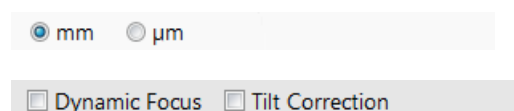
One can input text information (such as passwords, labels or precise numbers) using the keyboard within a corresponding edit box. Some edit boxes, that are not part of a dialog require confirming the input by pressing the *Enter* key. If you press the *Esc* key before leaving the edit box, its previous value will be restored.



## Radio buttons / Check boxes

Within a group of related round *Radio buttons*, only one selection can be active at any time by clicking on the individual box.

One square *Check box* or a group of *boxes* can be ticked / cleared by clicking on the individual square box.





## Adjusters

Adjusters allow the user to change parameters (such as contrast, brightness, etc.) in a continuous way.

Right-clicking on the adjuster shows a context menu with choices. Checking / not-checking the *Slider Mode* option switches between two possible ways of controlling the slider. Checking the *Mode Switch* option adds the mode switch button to the right side of the slider, which enables quickly switching between these modes.

### Slider mode

In this mode, the adjusters always have a label and a readout at the upper right corner. Double-clicking on it enables entering a precise value and a unit in particular cases using the keyboard.

Clicking on & dragging the middle adjuster button or clicking on the bar is used for coarse adjustments, while clicking on the end right arrows is for fine adjustments (single step increments).

- *Slider Mode (Non-linear Slider clear)* - the adjuster button position always corresponds to the actual parameter value within an available range.
- *Slider Mode (Non-linear Slider checked)* - the slider has an exponential response - the farther from the center the adjuster button is pulled, the larger the relative change. The adjuster button always snaps back to the center of the slider, but the small bar under the slider corresponds to the actual parameter value.

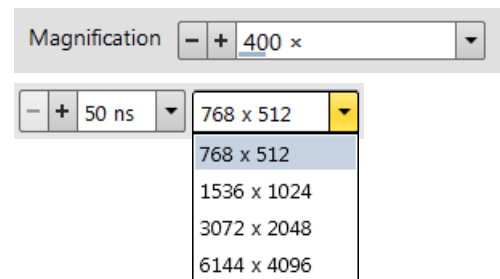
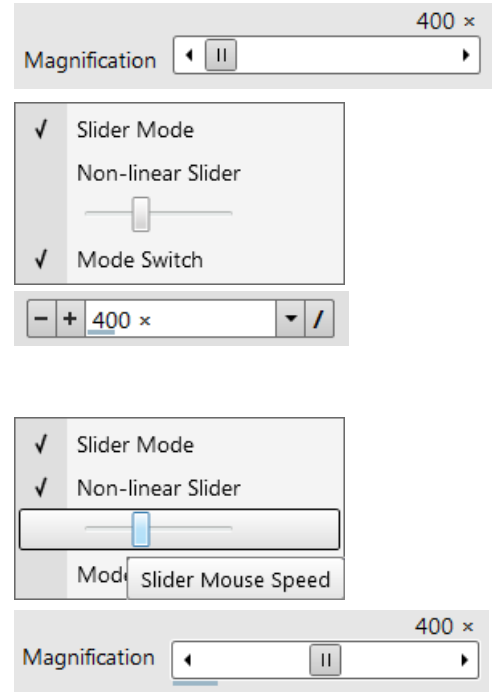
It is possible to increase / decrease the *Slider Mouse Speed* (sensitivity) by dragging the context menu slider to the right / left.

### Not Slider mode - drop down list boxes

This mode is used for values that have both a continuous range and a list of presets. It also offers direct value editing to achieve total control.

Clicking on the - / + sign selects the previous / next value from the predefined list (see appropriate Preferences), but only shows one value in the text area. Clicking on the down arrow on the right side of the adjuster or the value itself expands a drop down list of available values - if it extends further than is visible, a scroll bar appears. Clicking on a value from the list enters it as the actual one. The drop down list automatically closes, and the setting changes immediately.

Double-clicking on a value in the text area enables editing it. It is also possible to click on & drag the small bar under the numerical value to continuously change the setting (where applicable).



## 2D controls

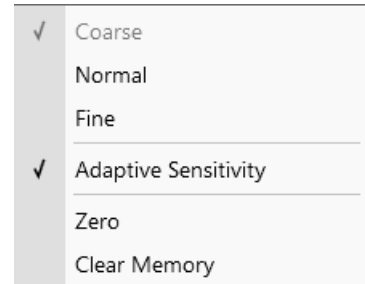
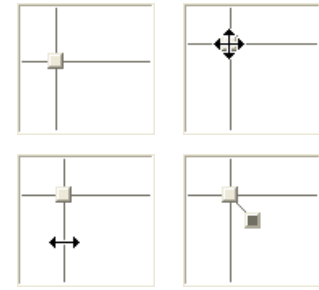
This control method is represented by an X-Y box. The position of the crosshair corresponds to the actual parameter value; its full range is represented by the perimeter of the box.

Clicking on & dragging anywhere inside the box changes the active cursor to the 4-ended arrow and positions it at the screen point corresponding to the actual control value (minimum in the middle of the screen and maximum at the edges). It can be dragged in four directions. Clicking on & dragging directly on the X / Y axis changes the active display cursor to the 2-ended arrow, which can be dragged only in the corresponding direction. To apply the value(s), release the mouse button.

Right-clicking on the 2D box opens a context menu with choices:

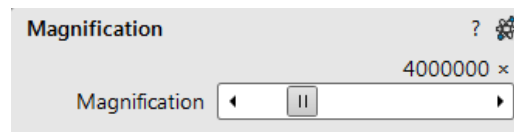
- *Coarse / Normal / Fine* item - sets the mouse sensitivity necessary for the full range from a long to a short mouse path.
- *Adaptive Sensitivity* item - adjusts the mouse control response to be the same at any magnification.
- *Zero* item - brings the control value to zero and the cursor to the center of the box.
- *Clear Memory* item - clears condition values, that have been remembered automatically during the relevant 2D control use. These remembered values are used to estimate new values, that have not yet been remembered.

The menu may contain fewer functions or some other functions that are available for that particular parameter. Selecting the corresponding menu item activates the function.



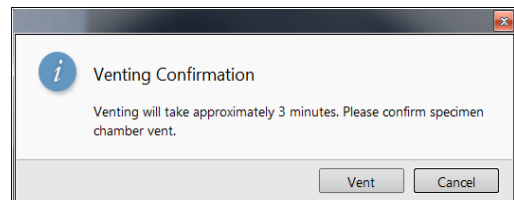
## Modules

Modules visually combine various software elements, that are related into a labeled group. Complex software elements such as Control pages or dialogs are typically composed of modules.



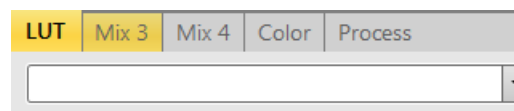
## Dialogs

A dialog appears when the system needs more information from you before it can carry out a command, or when the system wants to give you some important information. Some dialogs do not let you access other functions until you close them. Others let you perform other tasks while they remain on-screen and running (for example, the Preferences dialog can remain opened while performing other tasks).



## Tabs

In modules or dialogs containing more interface elements than would fit into the limited area, *Tabs* are used. These related elements are split into groups (sections), and each one is represented by a labeled Tab. Clicking on the Tab brings it to the foreground showing the corresponding group of interface elements. Tabs where some parameters were changed are highlighted (orange background).



## Progress bars

The progress of long, ongoing procedures is indicated in dedicated dialogs or modules.



## xT microscope Server

The *xT microscope Server* application starts and stops the software service controlling basic microscope functions as well as the user interface (UI) *Microscope Control* software.

Start the *xT microscope Server* from the Windows Start menu or by double-clicking its icon.

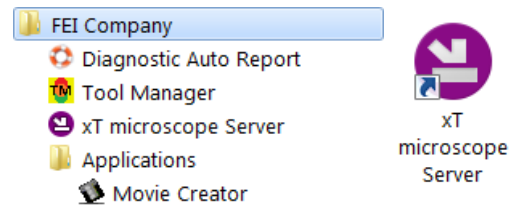
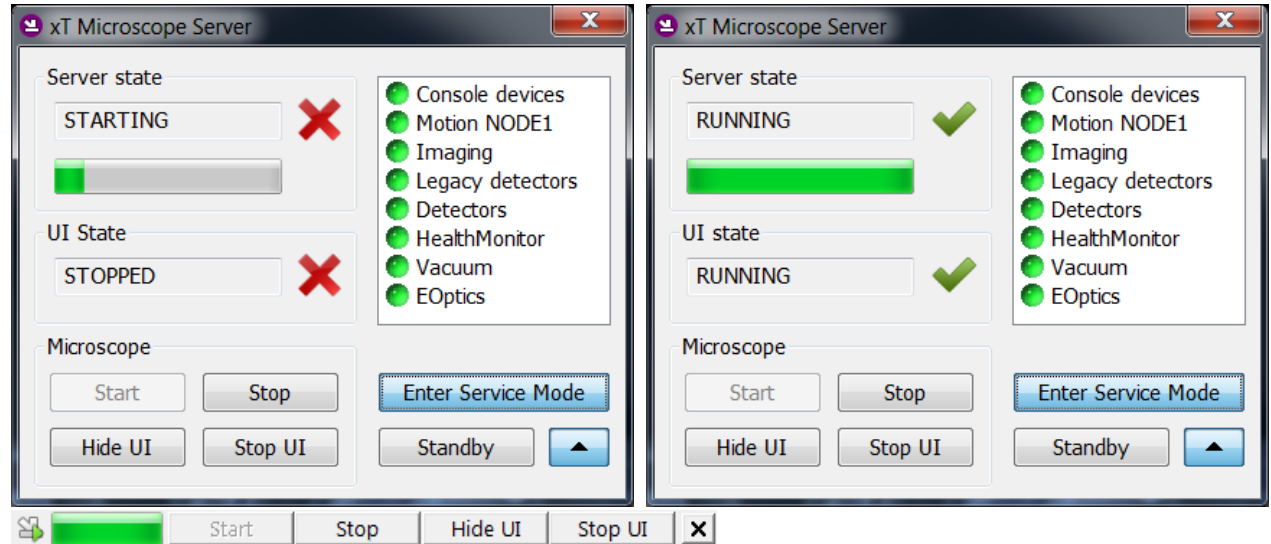


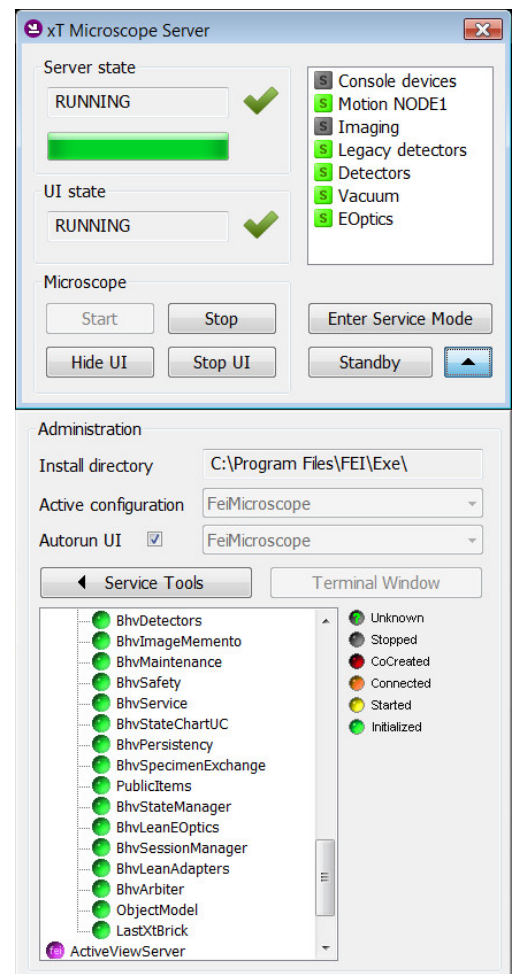
FIGURE 3-1: *xT microscope Server* window



Right-clicking on the title bar opens a context menu with options. Double-clicking on the title bar switches between full and miniature views. Some Microscope area buttons change their labels and behaviors depending on their actual state.

- *Server State / UI State* area shows the *STARTING / RUNNING / STOPPING / STOPPED* state of the *xT microscope Server / Microscope Control* software service.
- Clicking on the *Start / Stop* button starts / stops *xT microscope Server* services. If the UI is running, the *Stop* button first closes it.
- Clicking on the *Start UI / Stop UI* button starts / stops the UI.
- Clicking on the *Show UI / Hide UI* button shows / hides the UI main window.
- Clicking on the *Standby* button closes the UI, stops the *xT microscope Server* services and brings the console to the *Standby* state (see Chapter 2).
- Clicking on the *Enter Service Mode* button starts the special mode intended for service actions.
- Clicking on the *Up / Down arrow* shows the *Administration* area containing information helpful for a service intervention. (specifying the software operation / hardware function state). When the *Autorun UI* check box has been ticked (default), the *Start* button automatically starts the UI after starting the *xT microscope Server*.

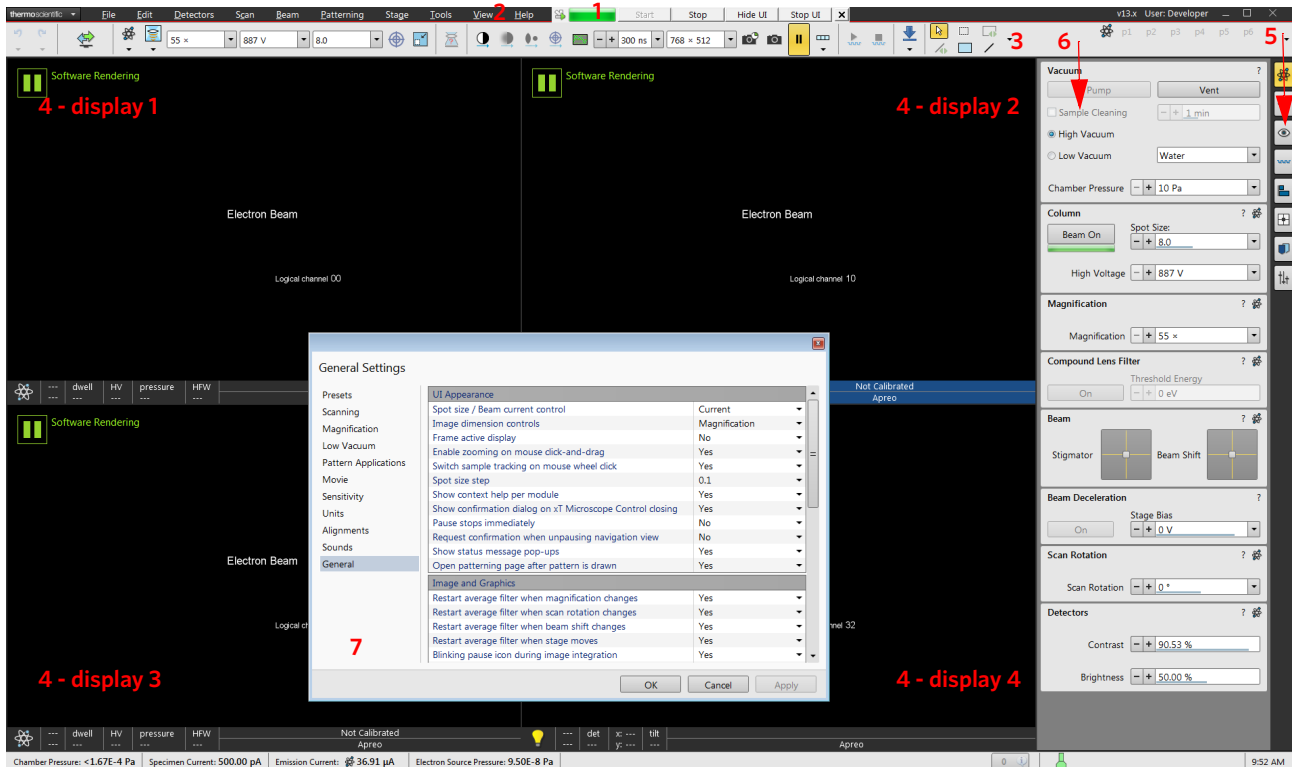
When the *Follow Active* check box is ticked (default), devices and drivers bullets roll down as the startup proceeds.



# Microscope Control

The Microscope Control application – simply the User Interface (UI) – is made up of several elements that compose the main window, showing status and control features within the Windows 7 operating system.

FIGURE 3-2: *Microscope Control window*



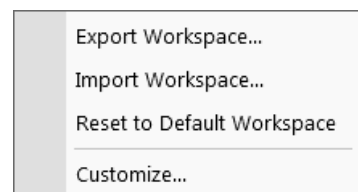
1. *xT microscope Server* – minimized application window
2. *Menu bar* – contains all operation menus and submenus
3. *Toolbar* – functional icons for the most frequently used microscope controls
4. *Imaging area* – also shows the adjustable Databar
5. *Control pages* – set of modules
6. *Modules* – microscope and imaging control elements
7. *Preferences dialog* – presetting of operating conditions

## Workspace customization

It is possible to change the UI layout by right-clicking any free toolbar or sidepane (pages) area and selecting the *Customize...* item.

A user can save / load layouts by selecting the *Export / Import Workspace...* item to / from the Workspace configuration (\*.workspace) file.

Clicking the *Reset to Default Workspace* item restores the factory UI layout, the one described in this manual.

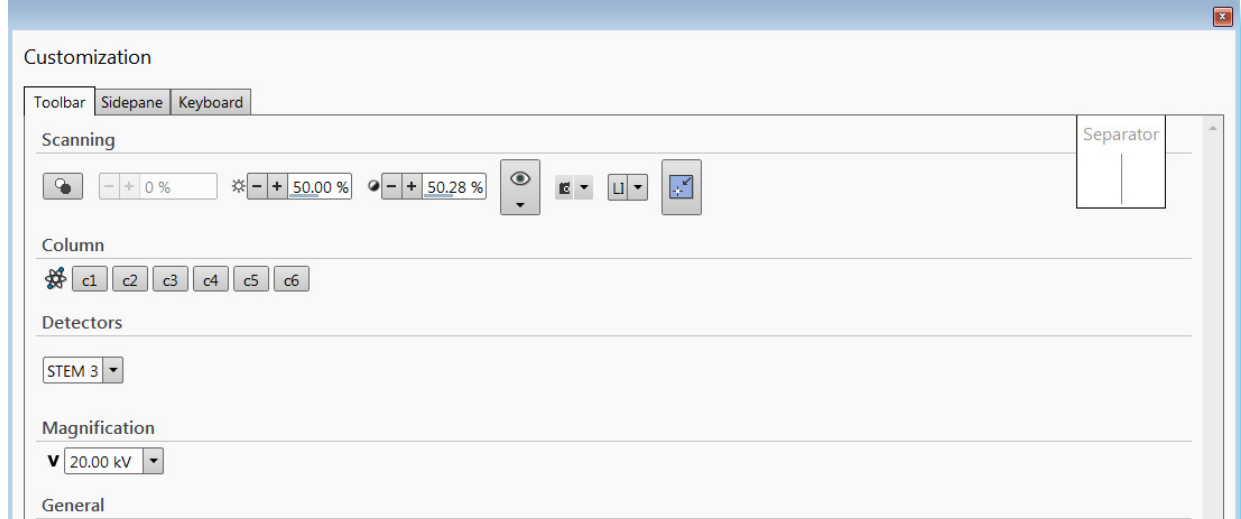


### Toolbar customization

Selecting the *Toolbar* tab adds a red triangle to each toolbar item, that allows changing its size. By clicking & dragging any item, that item can be moved to a new position within the toolbar area; dragging it out of the toolbar area to the customization window eliminates it from the layout. Clicking & dragging a new item from the *Toolbar* tab to the toolbar area adds it to the layout.

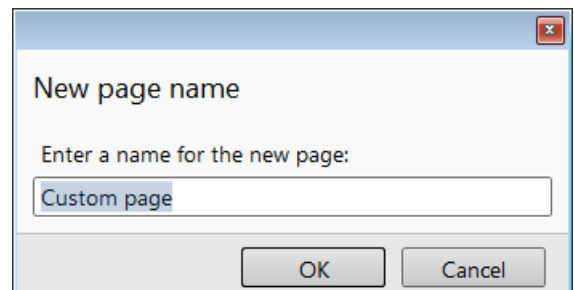
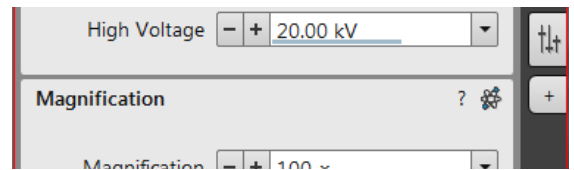


**FIGURE 3-3:** *Toolbar customization*

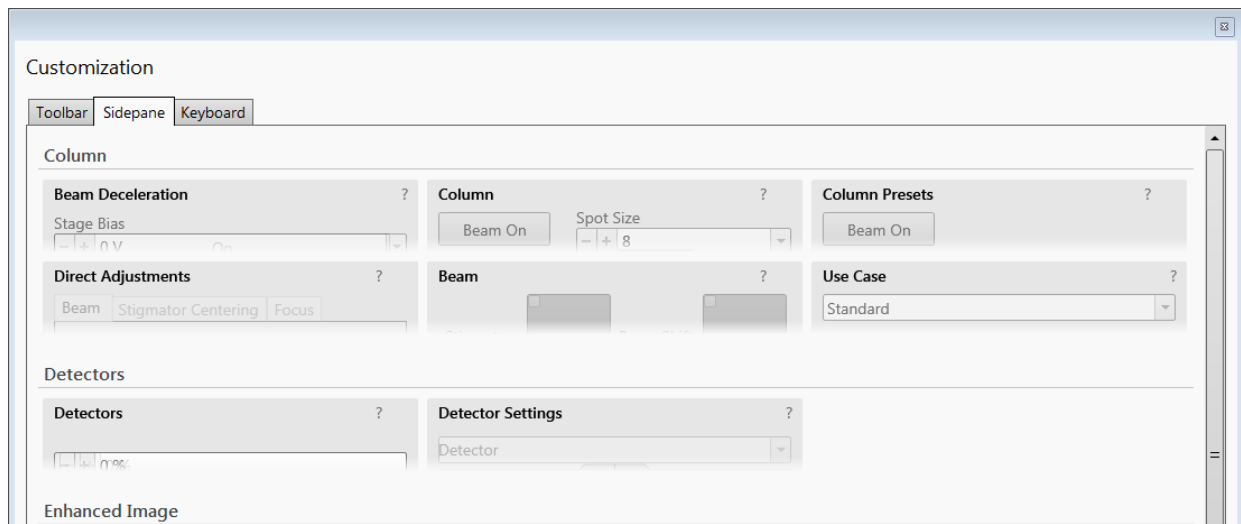


### Sidepane (Pages) customization

Selecting the *Sidepane* tab adds a red border to the pages area. By clicking & dragging any module, that module can be moved to a new position within the pages area; dragging it out from the pages area to the customization window eliminates it from the layout. Clicking & dragging a new item from the *Sidepane* tab to the page area adds it to the layout. Clicking the + page button calls up a dialogue requiring a *New page name* input; clicking the OK button creates a custom page.



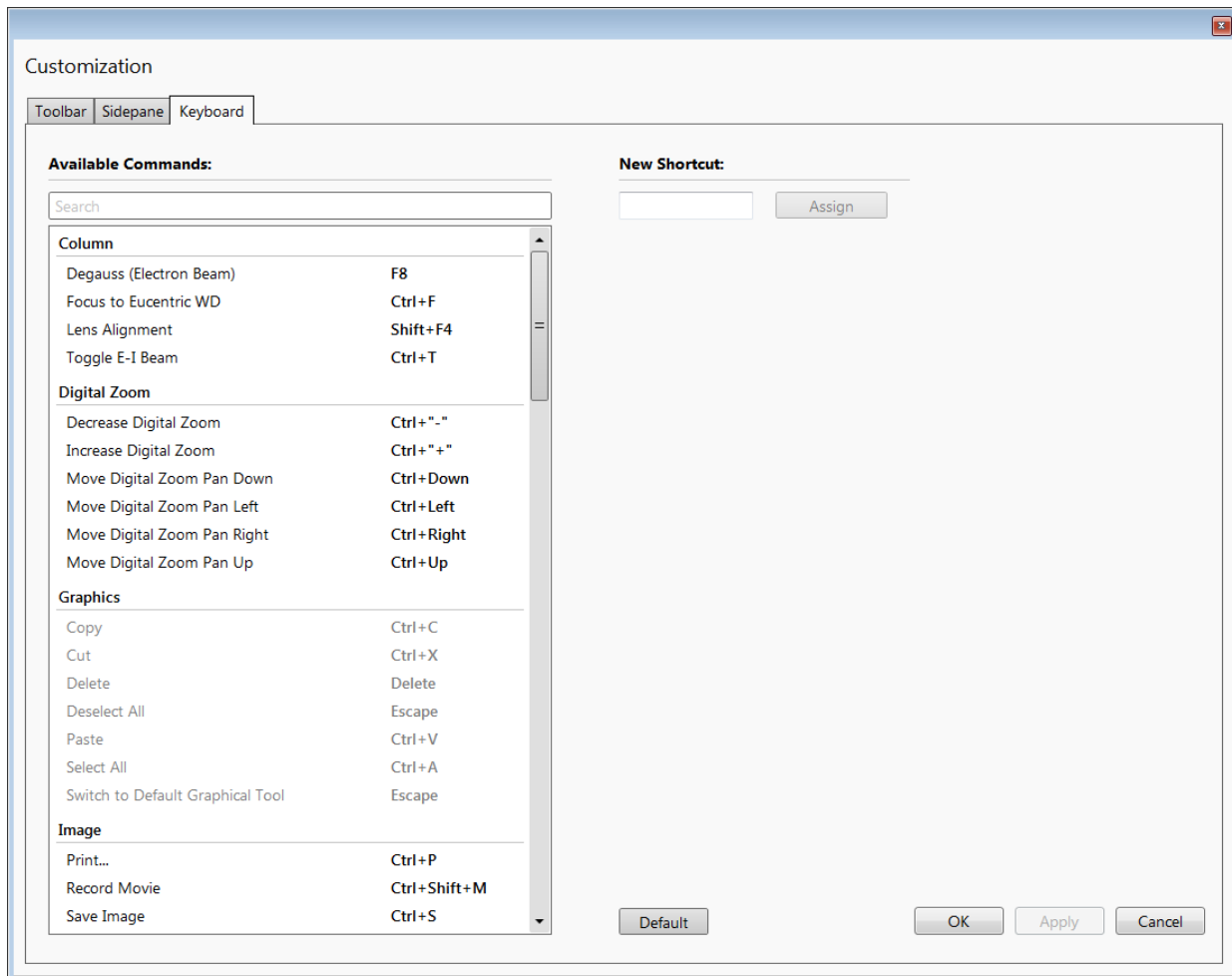
**FIGURE 3-4:** *Pages customization*



## Keyboard (Shortcuts) customization

It is possible to customize the factory shortcuts within the *Keyboard* tab. To change the factory settings, search for a desired functionality, enter a *New Shortcut* to the edit field, and click the *Assign* button. To revert to the factory settings, click the *Default* button.

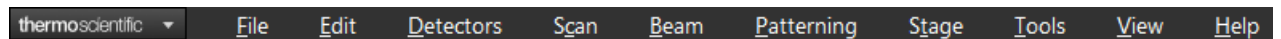
**FIGURE 3-5:** *Shortcuts customization*



## Menu bar

The pull-down menus are shown across the screen.

**FIGURE 3-6:** *The Menu Bar*



Expand pull-down menus from the menu bar by:

- Clicking on the Menu title
- Entering Alt + underscored keyboard letters
- Entering Alt + keyboard arrows + the Enter button

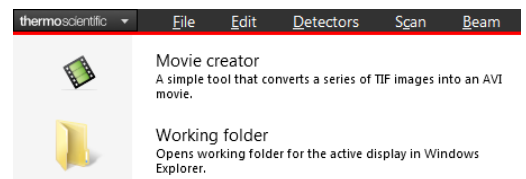
### Note

Some menu functions have their equivalents in the toolbar. When this is the case, the corresponding toolbar icon is shown next to the function title in the following text.

### thermoscientific menu

Standalone applications for particular use are listed here. It is also possible to start them.

- Movie creator  
A simple tool that converts a series of TIF images into an AVI movie.
- Working folder  
Opens working folder for the active display in Windows Explorer.
- If there are more applications installed with the system, they are listed here just as in the Windows start menu:  
all programs / FEI company / Applications / for instance: VolumeScope, Auto Slice and View, iFast, AutoTEM, ...



### File menu

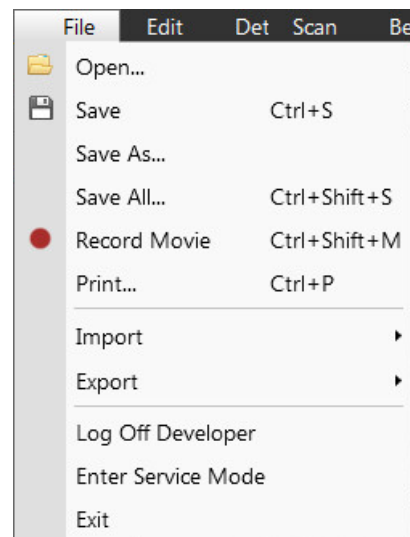
opens the File menu administrative functions:

#### Open

shows a standard dialog for opening images previously stored to media. Supported digital file formats are TIF8/16/24, JPG and BMP (see Chapter 5). The dialog shows, by default, the location (path) last used to open or save files from the UI.

#### Save (Ctrl + S)

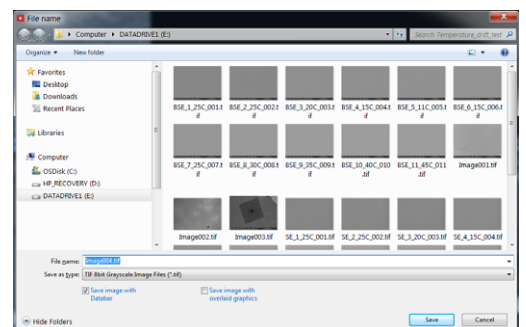
saves the image using the format, location and base name set by the last used *Save As* function in that display. An incremental suffix with a selectable number of digits ensures that every image is saved as a new file, e.g. Name\_001.tif, Name\_002.tif, etc.



#### Save As

opens a dialog for saving images, which provides an opportunity to change an image's file name and location. An image can be saved in *TIF8/16/24*, *JPG* or *BMP* file format.

The dialog shows, by default, the location and the name last used to save / open a file for the active display. A user can change a location, name base or suffix, select a different image format (*Save as type*), and also choose whether to *Save the image with / without Databar* and *with / without overlaid graphics* by ticking / clearing the appropriate check box. The settings are remembered and used for subsequent *Save* actions.





**Save All (Ctrl + Shift + S)**

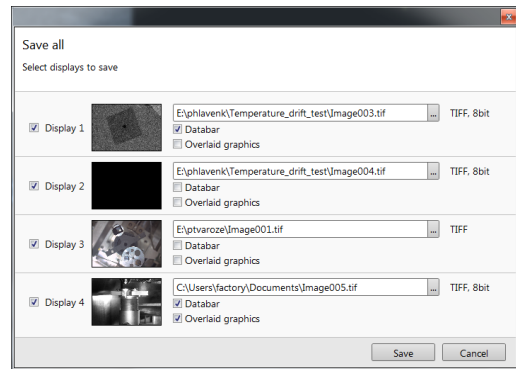
opens a common dialog for saving images from each display, providing an opportunity to change the file names and locations.

**Record Movie (Ctrl + Shift + M)**

allows a user to make digital video files (AVI) for dynamic experiments. The corresponding icon next to this menu item – red circle / square – indicates that movie recording is stopped / in progress (see Chapter 5).

**Print (Ctrl + P)**

opens the print dialog enabling a choice of printer and settings suitable for printing an image.



**Import / Export**



opens a sub-menu with choices for importable / exportable items. Selecting an item opens a standard Open / Save As dialog for choosing the location and file name. Following items can be imported (i.e. loaded and used) / exported:

- *Stage Positions* (.stg files) – stored stage positions
- *Patterns* (.ptf files) – active display parameters of (all) pattern(s)  
By importing these parameters, (all) exported pattern(s) is/are drawn back into the active display.
- *Scanning Presets* (.scp files) – preset scanning parameters
- *Display Presets* (.qps files) – active display parameters: Beam type / Detector type / Detector Mode / Detector contrast & brightness / Digital Contrast / Digital Brightness parameters
- *System Parameters* (.par files)  
A wide range of selected actual microscope settings are stored, including most of those mentioned above. When importing them back, only the selected settings are loaded.



**Log Off #user name#**

logs off the present User and provides the *Log On* dialog for the next microscope user. When a user logs off, the system goes into a safe state; the accelerating and detector voltages are automatically switched off.

**Caution!**

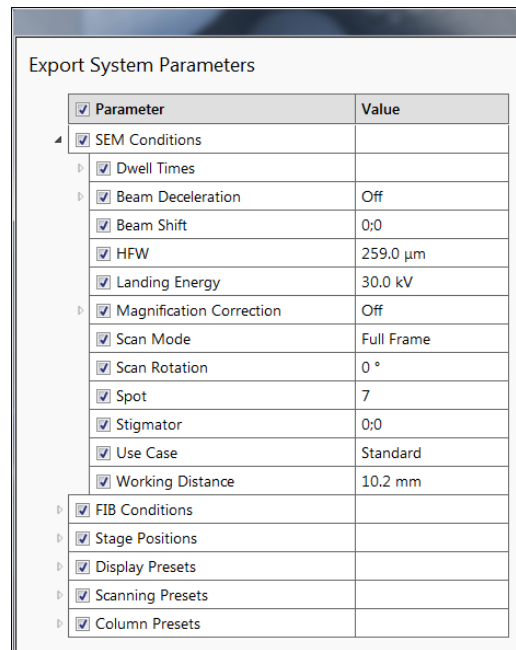
*Logging off the actual user does not close all microscope operations! (see Chapter 2)*

**Enter Service Mode**

starts the special mode intended for service actions.

**Exit**

closes the Microscope Control software (the actual user is automatically first logged off) and leaves a user in the operating system environment. The xT microscope Server is still running and still controls the microscope in operation.



**Edit menu**

opens some helpful functions:

**Undo (Ctrl + Z) / Redo (Ctrl + Y)**

reverts / restores some of the last used actions.

**Copy (Ctrl + C) / Cut (Ctrl + X) / Paste (Ctrl + V)**

These functions are commonly used operating system functions.

**Select All (Ctrl + A)**

selects All graphics in the active display.

**Delete (Delete)**

deletes all selected graphics in the active display.

Edit	Detectors	Scan
	Undo	Ctrl+Z
	Redo	Ctrl+Y
	Cut	Ctrl+X
	Copy	Ctrl+C
	Paste	Ctrl+V
	Select All	Ctrl+A
	Delete	Delete



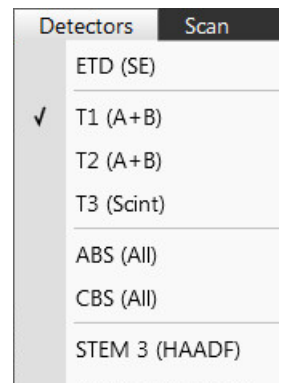
## Detectors menu

opens the choice of all installed Detectors (see Chapters 5 and 7).

### Detector list

contains various detectors for the microscope's operation. Detectors not mounted or not serviceable under actual microscope conditions are disabled (grayed out). The selected detector is remembered for the display. A tick shows next to its label, and its mode acronym is shown beside it in brackets.

- The 3rd party detector / video signal is indicated as "External". Contact an Thermo Scientific service person about connection details.
- The CCD camera reflects the inner space of the specimen chamber.
- *Mix* sets the possibility of interfusing signals from 2 or 3 detectors.



## Scan menu

opens the scanning control functions:

### Pause (F6)



pauses imaging. This function is used automatically with Snapshot and Photo functions.

Select the *Scan* menu / *Pause*, or press the *F6* button, or click on / double-click on the toolbar pause icon, to stop scanning at the end of the actual frame / immediately.

When the imaging is going to be paused at the end of a frame, the toolbar pause icon becomes highlighted (orange background) and there is a frame around it. When the imaging is paused, the icon is highlighted (orange background) and the green pause icon appears in the corresponding display.

Select *Scan* menu / *Pause* item, or press *F6* button, or click on the pause icon on the toolbar or in the display to release the pause function (the icon background becomes gray), returning the scanning to the previous state.

Shift + clicking on the toolbar *pause* icon pauses / activates all displays at once if the detectors in different displays are mutually compatible.

### Snapshot (F4) / Photo (F2)



activates a preset scan (see the *Preferences / Scanning* section) to acquire an image.

### Active Preset Snapshot (Ctrl + F2)

This item starts acquiring a snapshot with parameters corresponding to the active (highlighted by orange background) toolbar *Scanning Preset* button (labeled *s#*) (see further).

### Note

*Shift + clicking on the Photo (Snapshot) icon / Scanning Preset button, or pressing Shift + F2 (F4) / Ctrl + Shift + F2 key immediately takes a Photo (Snapshot) / Scanning preset snapshot from all displays with the same beam.*

### Videoscope (F3)

This function shows the video signal intensity along the actually scanned horizontal line for correcting the contrast and brightness.

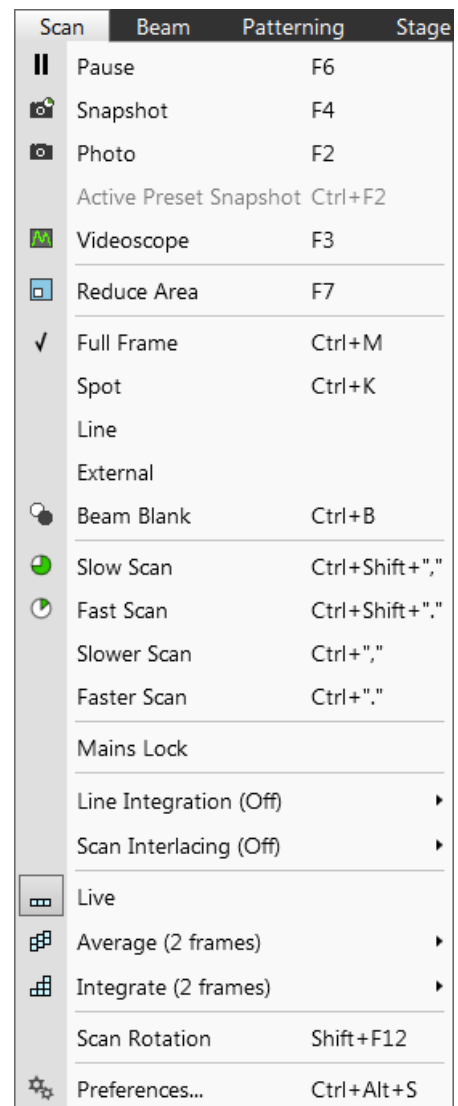
### Reduced Area (F7)



This mode is useful when focusing and correcting astigmatism, as the imaging update is faster in the smaller area. When a Reduced area is chosen, the green frame appears at the last used place onscreen. It can be adjusted by clicking on it & dragging. It is also possible to adjust the scan parameters independently in the full-frame setting.

- *Moving*: Place the mouse cursor over the selected area. The cursor changes to a 4-ended arrow. Click on & drag the selected area to the desired position and release the mouse button.
- *Changing the size*: Place the mouse cursor over the edge of the selected area. The cursor changes to a 2-ended arrow, either horizontal or vertical. A corner can also be used to move two sides. Click on & drag the side out or in to obtain the desired size and release the mouse button.

When the Reduced area frame is being manipulated, it turns yellow until released. It then reverts back to green.



**Full Frame (Ctrl + M)**

This is the default scanning mode. It is typical for navigation and imaging.

**Spot (Ctrl + K)**

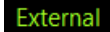
When starting this mode, the actual beam position is represented by a green cross in all imaging displays. You can click on & drag it, or click anywhere around the screen, to change its position.

**Line**

In this mode, the green horizontal line is shown in all imaging displays. The beam scans along this line. You can click on & drag it, or click anywhere around the screen to change its position.

**External**

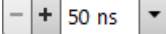
switches to activate external control of the scanning system, such as an EDX system beam control. The external scanning mode is indicated by the *External* label shown in the upper right corner of all imaging displays.


**Beam Blank (Ctrl + B)**

If its functionality is active, this is indicated by the icon next the scan menu item. It deflects the beam off-axis, high in the column, and protects the specimen from unnecessary exposure. Selecting the item again releases the blanker and returns the beam to scanning the specimen.

**Slow / Fast Scan (Ctrl + Shift + , / .)**

brings the scanning condition to the preset Slow / Fast scan value (see the Preferences / Scanning section).

**Slower / Faster Scan (Ctrl + , / .)** 

sets the scanning condition to the next preset Slower (-) / Faster (+) value (see the Preferences / Scanning section). The adjuster shows the actual dwell time, but does not enable directly editing its value. The value can be selected from the drop-down list (see the Preferences / Scanning section).

**Mains Lock**

When ticked, the scanning (line sawtooth signal) is synchronized with the mains AC oscillation. This greatly diminishes blurring and jittering of the electron imaging, resulting in smooth image edges at higher magnifications and slow scan conditions.

**Line Integration**

With this function, each line scan is repeated several times (from 2 to 255) before proceeding to the next line. Signal data collected from these passes are integrated and shown as an actual image line.

This imaging method reduces sample charging (in comparison with a single pass with a longer dwell time) and improves the overall image quality.

**Scan Interlacing**

This function splits an imaging area into a large number of blocks defined by the number of lines (from 2 to 8). The first line of each block is scanned, followed by the second one, etc. This imaging method significantly reduces sample charging.

✓	Off	✓	Off
	2		2
	4		3
	8		4
	16		5
	32		6
	64		7
	128		8
	255		

Note 

These two functions cannot run simultaneously. When any of them is active, it is indicated in the toolbar dwell time adjuster by the letters LI / SI. Its status is also depicted next to the Scan menu / Line Integration or Scan Interlacing item within the brackets.

**Live** 

is the default mode, leaving the imaging unfiltered for collecting raw direct images. One frame follows another.

**Average** 

Filter continuously averages a specified number (2 or more) of frames, resulting in a better signal-to-noise ratio. This process continues until stopped by changing the scanning condition or by pausing the imaging.

This is used mostly for fast scanning to reduce imaging noise. During averaging, the image is updated continuously, and actions such as focusing, moving the stage, etc., can still be performed.

Note

The Average is also set independently for the optical window, but using averaging with more than 4 frames is not recommended, especially when moving the stage.

**Integrate**

Filter allows cumulative noise reduction by true integration over a specified number (2 or more) of frames. This process continues until the selected number of frames is reached. It then automatically pauses the imaging.

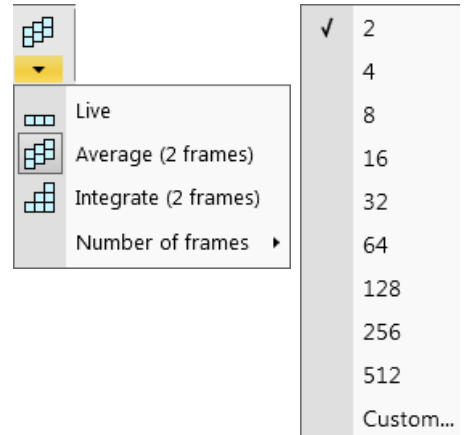
This can be used as an alternative to slow scanning to obtain high quality images of slightly charging specimens.

**Note**

Clicking on the down arrow below the toolbar icon shows menu items *Live / Average (# frames) / Integrate (# frames) / Number of frames*, enabling the user to select the number of averaged or integrated images (depending on the actually active filter indicated by the icon for the active display). Clicking on the toolbar icon itself changes the *Live / Average / Integrate* filter in cycle.

The *Number of frames* is set and remembered independently for the Average and Integrate filters. Both the filter and Number of frames are set and remembered per display, so live and filtered imaging can run at the same time. Settings are particular for the *Reduced Area, Full Frame* and for the *Line scan*. The *Photo / Snapshot* function uses the Integrate and Number of frames pre-set (see the *Preferences / Scanning* section).

As scanning can take a significantly long period of time, one can restart scanning from its beginning by pressing the *Ctrl + R* keys.

**Scan Rotation (Shift + F12)**

This on-screen tool is activated to rotate the scan field. It has no effect on the stage movements, and is solely a scan coil/electrode function used to orient the imaging relative to a specimen feature and/or detector direction.

A non-zero scan rotation is indicated by an icon in the *Status bar*.

**Preferences (Ctrl + Alt + S)**

Clicking this item opens the *Preferences dialog / Scanning* item (see further).

**Beam menu**

opens the Beam menu functions:

**SEM Aperture**

This item is not available for the user / supervisor accounts. It is intended for service interventions.

**Home SEM Apertures**

This function sends the SEM final lens aperture (Automatic Aperture System - see Chapter 2) to its home position in case of trouble.

**Degauss (F8)**

This feature triggers the procedure that puts all actually used electron lenses to a normalized state by removing their hysteresis effects. For a few seconds, while the procedure is running, all live imaging disappears or turn fuzzy. It then returns.

Use this function with (almost) focused imaging to obtain the most accurate Magnification, Horizontal Field Width (HFW) and Working Distance (WD) readouts.

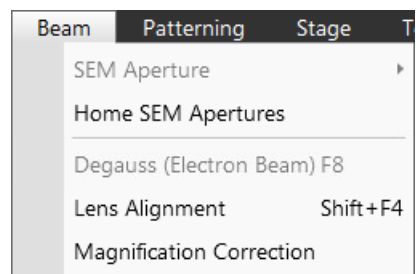
**Lens Alignment (Shift + F4)**

This feature activates / deactivates the final lens alignment mode for the fine alignment of the electron beam only. The scanning conditions change to the last selected value, the lens modulator turns on, and the alignment cross appears in its respective position in all imaging displays.

Clicking on & dragging within a display activates a 4-ended arrow cursor and starts the final lens alignment.

**Magnification Correction**

Applies the *Magnification Correction* alignment influences on imaging. The letter "c" is added to the appropriate image databar fields (Mag, HFW), and the text *Magnification Correction* is added to the imaging display.



**Magnification Correction**

## Patterning menu

opens the Patterning menu functions (see Chapter 5):

### **Start / Pause / Resume Patterning in Display # (Pause button)**



starts / pauses patterning of the enabled pattern(s) in the active display. The menu item and the corresponding toolbar icon change according to the actual condition.

### **Reset Patterning in Display # (Ctrl + Pause button)**



cancels the patterning procedure.

### **Next Pattern (Shift + P)**

In the serial patterning mode the actual patterning is stopped and the procedure continues with the next pattern (if present).

### **Autostart Real Time Monitor**

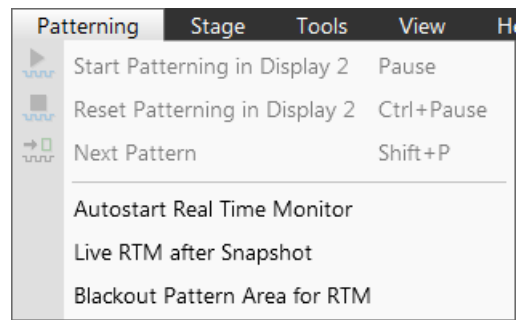
When selected, it releases the pause function for the display with patterns, enabling an automatic start of the real time monitoring (RTM) of the milling process.

### **Live RTM after Snapshot**

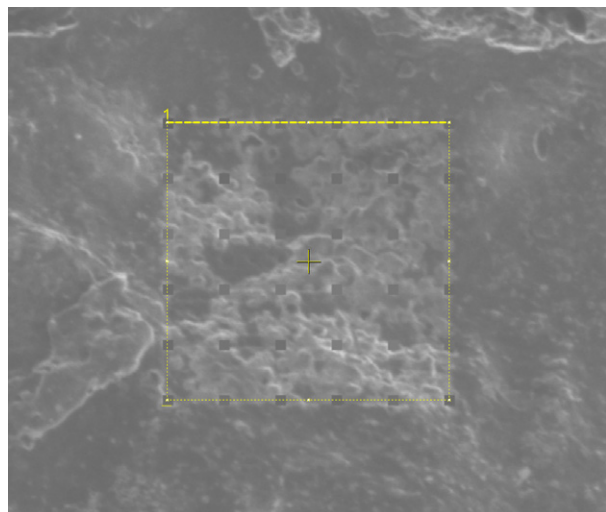
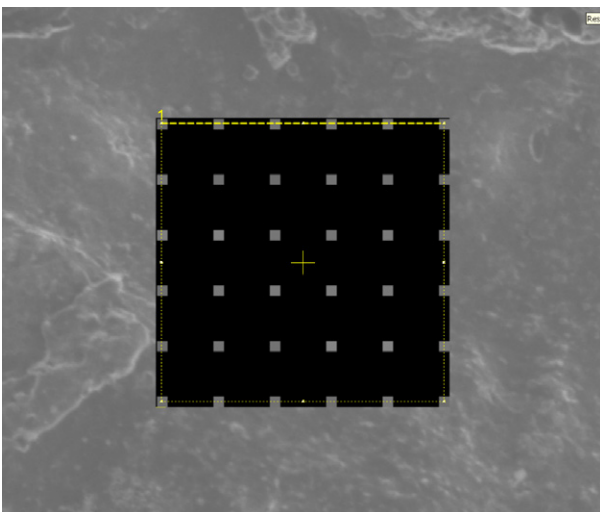
After acquiring a snapshot, the RTM feature continues automatically.

### **Blackout Pattern Area for RTM**

In case the Real Time Monitor is running, the area not milled is darkened to enhance the visibility of the RTM information. The visibility of the individual patterning pixels is greatly enhanced (this is especially important for patterns with extremely large pitch or very thin lines).



**FIGURE 3-7:** Imaging with / without Blackout Pattern Area



## Stage menu

opens the stage and sample navigation functions (see Chapter 5):

### **Align Feature**

opens the procedure that helps set a stage position for any elongated feature (extending off the screen at the desired magnification). The procedure uses the stage rotation.

### **Compucentric Rotation (F12)**

places a green circle in the active display. By rotating the circle, a different viewing orientation of the sample area can be achieved by a physical stage rotation and adjustment of the X and Y axes. Stage rotation keeps the observed feature in the center of the field of view. If this does not occur, an alignment should be performed to locate the stage center and calibrate the stage (see Chapter 4).

### **Beam Shift Reset**

zeroes the beam shift. A feature observed with a non-zero Beam Shift is automatically moved back to the imaging center using the stage.

### **Auto Beam Shift Zero**

automatically resets the beam shift each time it reaches the maximal value during the Get function (the point-to-point stage movement) and corrects the imaging position with a stage movement.

### **Home Stage (Shift + F3)**

starts the procedure that moves all motorized axes to their hardware limits and ensures that the physical stage position agrees with the coordinates readout. During the home stage procedure the *Stage Homing* dialog shows its progress. The stage axes are moved to their end-switches in the following order:

1. Z (lowest position); 2. T (tilt); 3. X, Y and R (rotation) at the same time.

When the stage is homed correctly it ends up in the following position:

The X / Y position is set to the factory pre-set stage rotation center; R = 0° / T = 0° / Z = preset long working distance.

### **Home Stage Without Rotation**

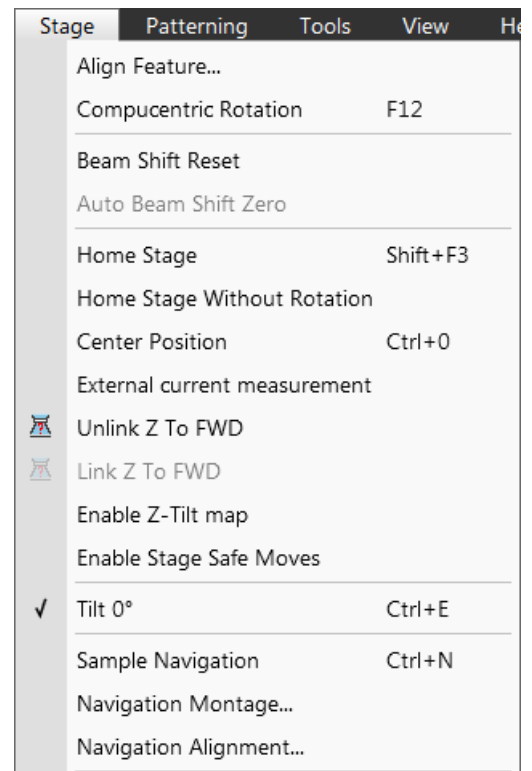
executes the Home Stage function without rotation. When the stage is homed without rotation, the stage Rotation reference is grayed out. This is useful when a large specimen is inserted and stage rotation can cause a collision with equipment inside the chamber.

### **Center Position (Ctrl + 0 - digit)**

moves the stage to coordinates X = 0, Y = 0.

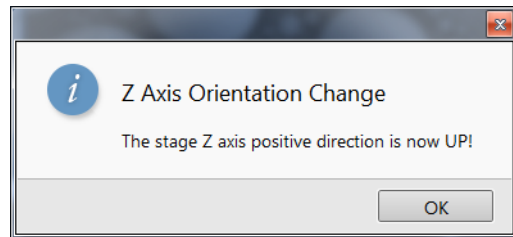
### **External Current Measurement**

Click on this item when you need to use an external measuring device (option). The *Status bar / Specimen Current* value shows N/A from that point on.



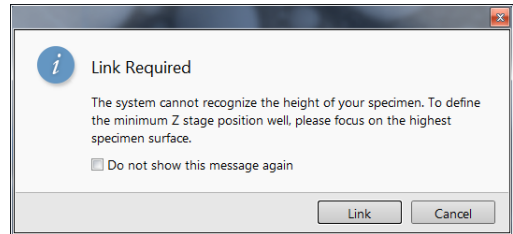
**Unlink Z to FWD**

This feature functions in the opposite way as the Link Z to FWD (see below). The Z coordinate value then represents the distance from the Z-axis home position (stage base). The dialog warns of the stage Z-axis positive move direction.

**Link Z to FWD**

This functionality provides the system with definite stage positioning to perform accurate and secure movement between the sample top surface and the end of the objective lens. The Z coordinate value then represents the actual Free Working Distance (FWD) value. The related toolbar icon changes according to the Z-coordinate status:

- **Grayed icon:** the function is disabled - the tooltip gives the reason (for instance, high voltage is switched off, all displays are paused, beam is not on,...).
- **Red question mark:** the function is enabled - Z is not linked to FWD. Use this function as soon as possible after a proper focus.
- **Red circle arrow:** the function is enabled - Z is roughly linked to FWD, but it needs correction. It happens e.g. after: pumping the chamber when specimens were exchanged, or focusing and linking Z to FWD at a long WD and then moving the stage to a short WD. In this case, focus carefully at a WD of around 7 mm, and use this function again.
- **Green 2-ended arrow:** the function is enabled - Z is properly linked to FWD. Now it should be safe to change the working distance by setting the Z coordinate in the Stage module.

**Note**

The Do not show this message again check box disables this notice permanently.

**Enable Z-Tilt Map**

Some movements of the tilted stage are not safe because of a possible collision with the final lens. The table (not user editable), with pairs of values, indicates the maximum safe Tilt angle for a certain Z value when linked. It can be used to guarantee safe usage of the stage (tilt restriction) for flat samples only and when a proper Link Z to FWD has been established.

**Enable Safe Stage Moves**

When ticked, the software takes into account all accessories installed inside the chamber. It is why the stage doesn't move to the target position in a straight path. When the magnification is large and stage movements are expected to be minute, it is not necessary to switch on this functionality.

**Tilt 0° (Ctrl + E)**

This menu item tilts the stage to 0°.

**Sample Navigation (Ctrl + N)**

toggles on / off the function that enables navigating electron imaging (scan field) towards desired points on a specimen using either a paused or a loaded sample image (usually captured at much lower magnification).

The Sample Navigation can be selected independently for any display, regardless of its actual content and status. A tick next to the menu item indicates that the function is active for the active display. As soon as imaging is paused, the Sample Navigation indicator appears in the upper right corner of the display. The indicator is green as long as the paused imaging can be used to navigate the live one. Otherwise it turns red.

**Navigation Montage**

This procedure enables capturing the sample Navigation image to be used in the Sample Navigation.

**Navigation Alignment**

This procedure aligns the Navigation image according to the live reference image.



## Tools menu

opens the Tools menu functions:

### **Auto Contrast Brightness (F9)**



activates the automatic contrast and brightness routine. The system attempts to set the Contrast & Brightness of the selected detector in the active display to suit the actual sample and conditions so that the majority of gray levels are shown. This functionality is also available for paused imaging.

#### Note

Pressing the Shift + F9 hot key starts the Auto Contrast Brightness functionality in all live displays.

### **User Auto Contrast Brightness**

examines gray levels of the active display imaging and stores their minimums and maximums. The next time the Auto Contrast Brightness (ACB) function is used, it attempts to set the Contrast & Brightness so that the resulting imaging gray levels lie between these minimums and maximums instead of full black and white.

A tick next to this menu item indicates that the user gray level limits are active. Clearing the tick reverts the ACB to its default setting.

### **Auto Focus (F11)**



activates the automatic focus routine for either beam. The system attempts to correct focus at any working distance.

### **Auto Stigmator (Ctrl + F11)**



activates the automatic procedure to correct any astigmatism.

#### Note

Auto-functions are only enabled during live imaging.

### **Auto Lens Alignment**



activates the automatic Lens Alignment functionality (see above).

### **Set HFW (Ctrl + H)**

enables setting the desired Horizontal Field Width, i.e. the width of the scanned area. This is an alternative to setting the magnification.

### **Display Saturation (Shift + F11)**

shows signal clipping in the active display by means of replacing the full black / white with dark blue / yellow color. The function can be used for electron imaging, but cannot be applied to optical imaging.

Showing saturation is selected independently for each display. A tick next to the menu item indicates whether the function is active for the active display.

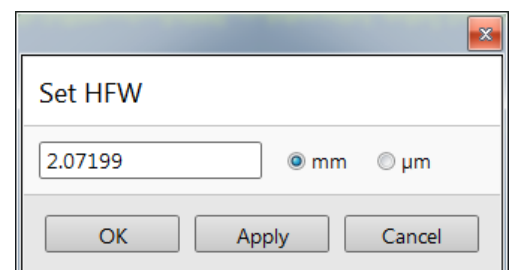
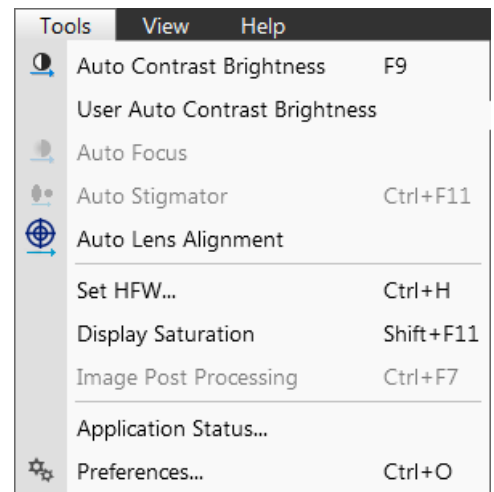
### **Image Post Processing (Ctrl + F7)**

Starting this function changes image appearance according to the *Enhanced Image* module / *Process* tab setting.

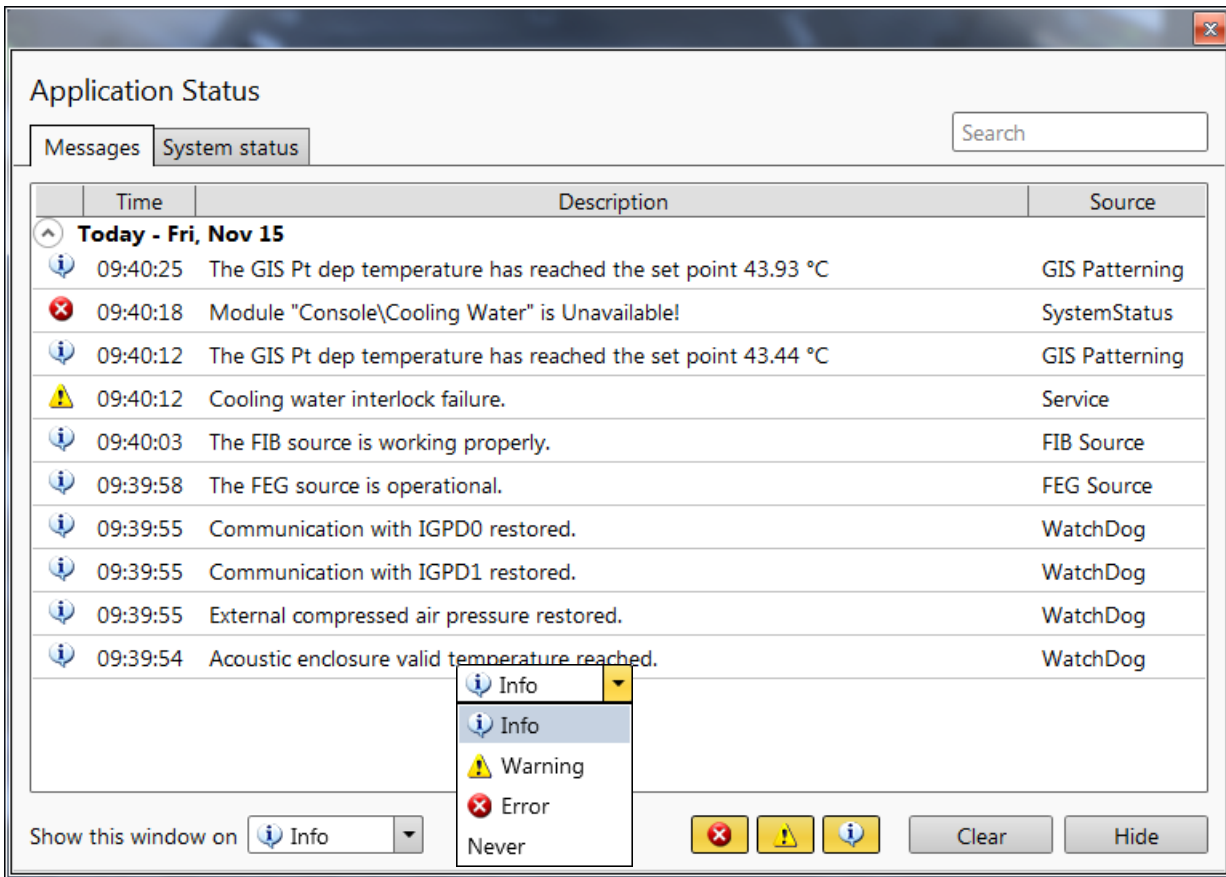
### **Application Status**

The dialog shows continuously updated system *Messages*. The *System status* tab offers information about the system hardware. That information is used by service engineers.

- *Show this window on* (Info / Warning / Error / Never) specifies the kind of messages that are automatically called up on-screen.
- Three icons enable separately switching on (orange background) / off (gray background) the showing of Error / Warning / Information messages.
- *Clear* button clears all present messages from the window.
- *Hide* button hides the Application Status window.



**FIGURE 3-8:** *Application status*



**Preferences (Ctrl + O - letter)**

Clicking this item opens the *Preferences* dialog (see further).



**View menu**

opens the Window menu functions:

**Center Cross (Shift + F5)**

places a cross in the center of all imaging displays. This function is automatically used in Alignment procedures to aid the centering of features and can be used to align a sample against a stored image in another display.

**Alignment Rectangle (Shift + F6)**

places a dashed rectangle in the center of all electron imaging displays. This function is automatically used for some Alignment procedures.

**CCD Axis Marker**

places axes indicators in all optical imaging displays to help the user with 3D orientation.

**CCD 10 mm Marker**

places a short horizontal line with a 10 mm label in all optical imaging displays to help the user with positioning a sample to a correct working distance and with the first focusing. Only a Supervisor is allowed to change the marker position by double-clicking on a new position.

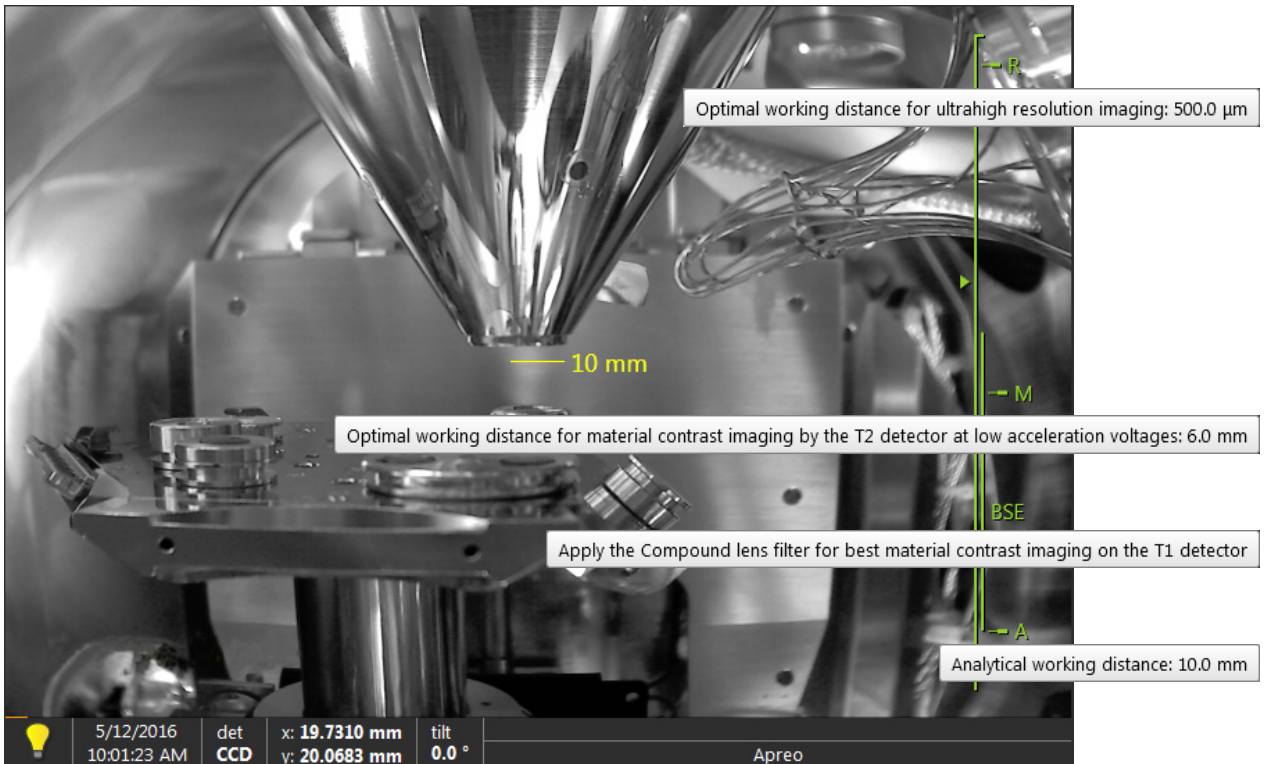
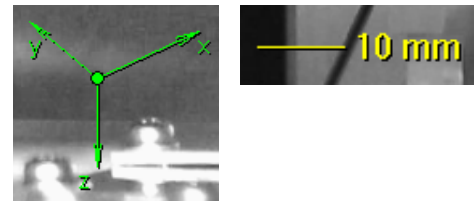
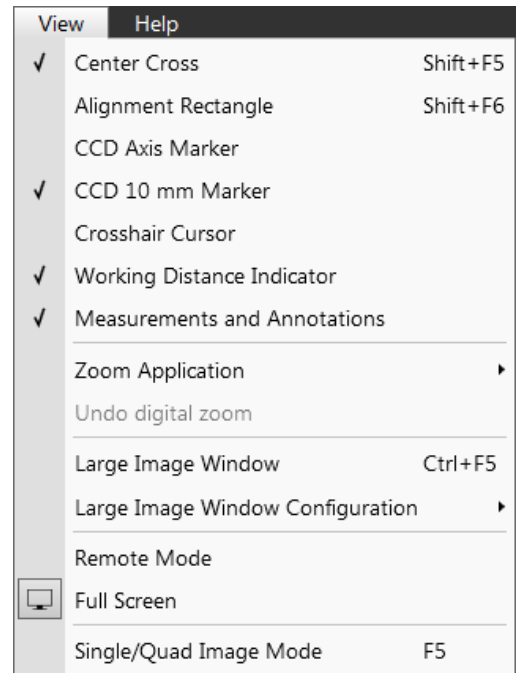
**Crosshair Cursor**

shows the cursor as a rectangular cross through the entire display.

**Working Distance Indicator**

Checking this item displays the working distance indicator within the optical display.

The small green triangle on the left of the vertical line depicts the actual working distance. The marked positions on the right are dynamically changed according to imaging conditions. They correspond to different applications and are described via the tooltip. If an imaging within specific working distance range is not optimal or possible, the green line turns to gray.



**Note**

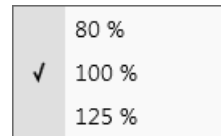
The BSE range is shown only when the feature is installed on the system (see the Compound Lens Filter module below).

**Measurements and Annotations**

Checking this item enables to use the measurements and annotations functionality within all displays. Not checking this item makes dedicated toolbar icons inactive and hides all measurements and annotations graphics, which is convenient during working with patterns.

**Zoom Application**

This functionality enables enlarging / reducing the Microscope Control application controls size (labeling texts, icons, etc.).

**Undo / Redo Zoom #**

When any Digital zoom is applied, this functionality switches between the applied zoom factor and no zoom (a factor of 1).

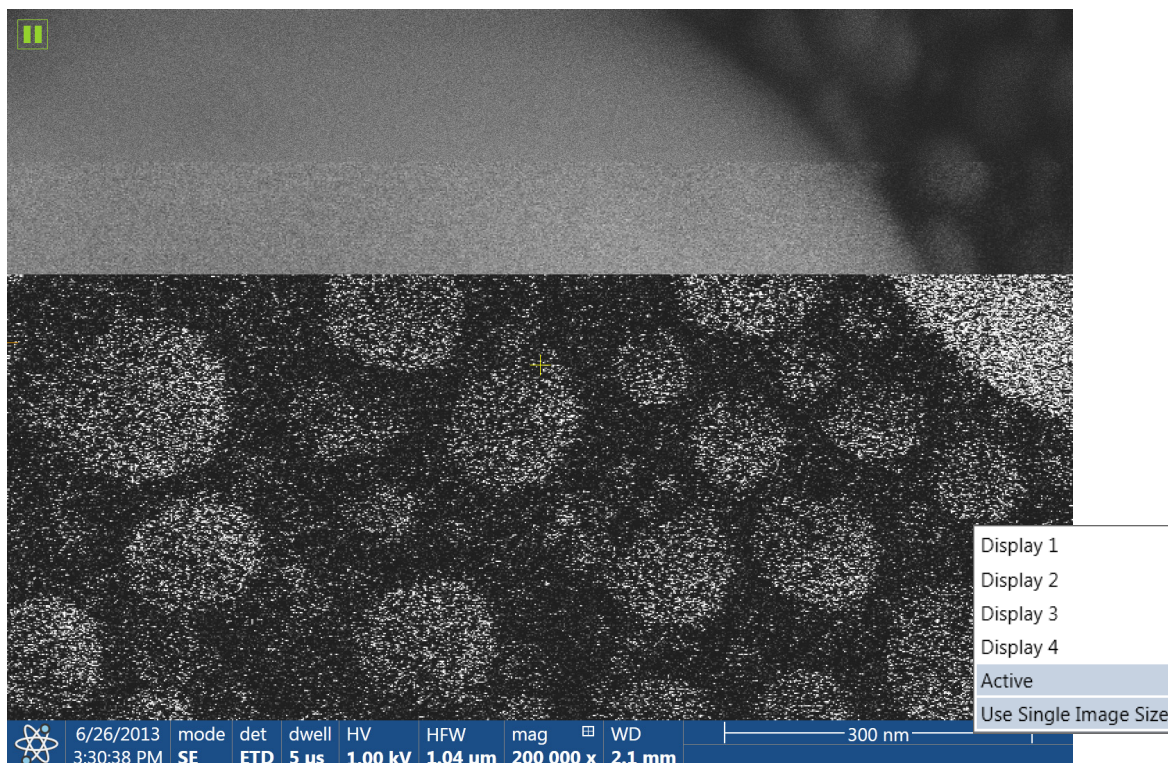
**Note**

To revert the last step, use the Edit menu / Undo (Ctrl + Z) functionality, which is also available at the toolbar.

**Large Image Window (Ctrl + F5)**

This function activates / deactivates full screen imaging on the secondary monitor.

**FIGURE 3-9:** Large image window

**Large Image Window Configuration**

Here one can select, whether to show the Active display, or any selected display. Activating the *Use Single Image Size* option sets the imaging window size corresponding to the Single Image mode size. These options are also available in the bottom right corner of the large image window.

**Remote Mode**

When ticked, this feature enables correct UI imaging at a remote site. It is also used for remote servicing. Use of this function slightly decelerates the UI performance.

**Full Screen**

Selecting this option sets the application to be shown in full screen. De-selecting it shows the application as a window within the screen.

**Single / Quad Image Mode (F5)**

toggles the imaging area between two possibilities:

- Single image mode shows one display over the whole UI imaging area (useful for observing details).
- Quad image mode is useful for comparing imaging of the same sample area taken with different detectors or under different scan conditions.

In the Single image mode, the active display fills up the screen.

## Help menu

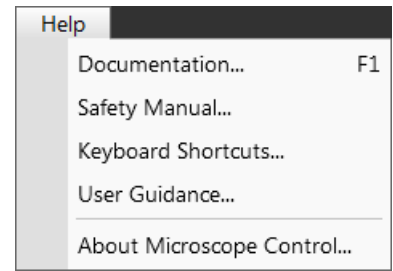
opens the Help menu and system information functions:

### Documentation (F1) / Apreo User safety manual

The complete *User operational manual / Apreo User safety manual* in PDF format is opened using an embedded Acrobat Reader, with its useful navigation, search, and selection facilities. The window remembers its position and size for the next time it appears.

### Note

*It's a must for any microscope operator to read the Apreo User safety manual before using a microscope for the first time.*

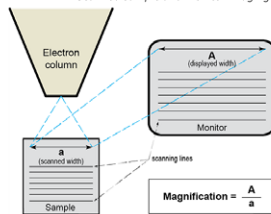


**FIGURE 3-10:** Online documentation

### Magnification

Magnification is calculated as the shown dimension (L) divided by the sample scanned dimension (l).  
 If the observed sample area is made smaller while the monitor size remains constant, the magnification increases. At low magnification, one gets a large field of view. At high magnification, only a tiny sample area is imaged. It is possible to set a corresponding databar magnification readout in the Quad Image and Single Image modes and in the saved image (see the *Preferences / Magnification* section).

**FIGURE 5-6:** Scanned sample and monitor imaging



### Changing Magnification

- **Toolbar list box** - used to choose from predefined values
- **Keyboard control** (+ / - / \*) - the numeric pad plus key (+) / the minus key (-) increases / decreases the magnification 2x and rounds the value. The star (\*) key rounds the magnification value (e.g. 10.063x becomes 10.000x).
- **Mouse wheel control** - coarse / fine control can be operated by the Ctrl / Shift key and rolling the mouse wheel up / down to increase / decrease the magnification.
- **Selected Area Zooming In / Out** - a quick way of zooming in / out on an area of interest. Click inside the imaging area & drag to make a dotted box over the area of interest (the cursor changes to a magnifying glass with a + sign). Release the mouse button, and the selected area increases to fill the whole imaging area with respect to the sides ratio. Clicking on & dragging + Shift consecutively reverses the above described technique (the cursor changes to a magnifying glass with a - sign). The Esc key cancels the operation at any time.
- **Magnification module**
- **Digital Zoom module**



## Keyboard Shortcuts

Clicking on this item starts Adobe Reader to show the shortcuts list. We advise printing out this document and place it near the microscope workplace in a location where it can be easily seen.

**FIGURE 3-11:** Keyboard shortcuts

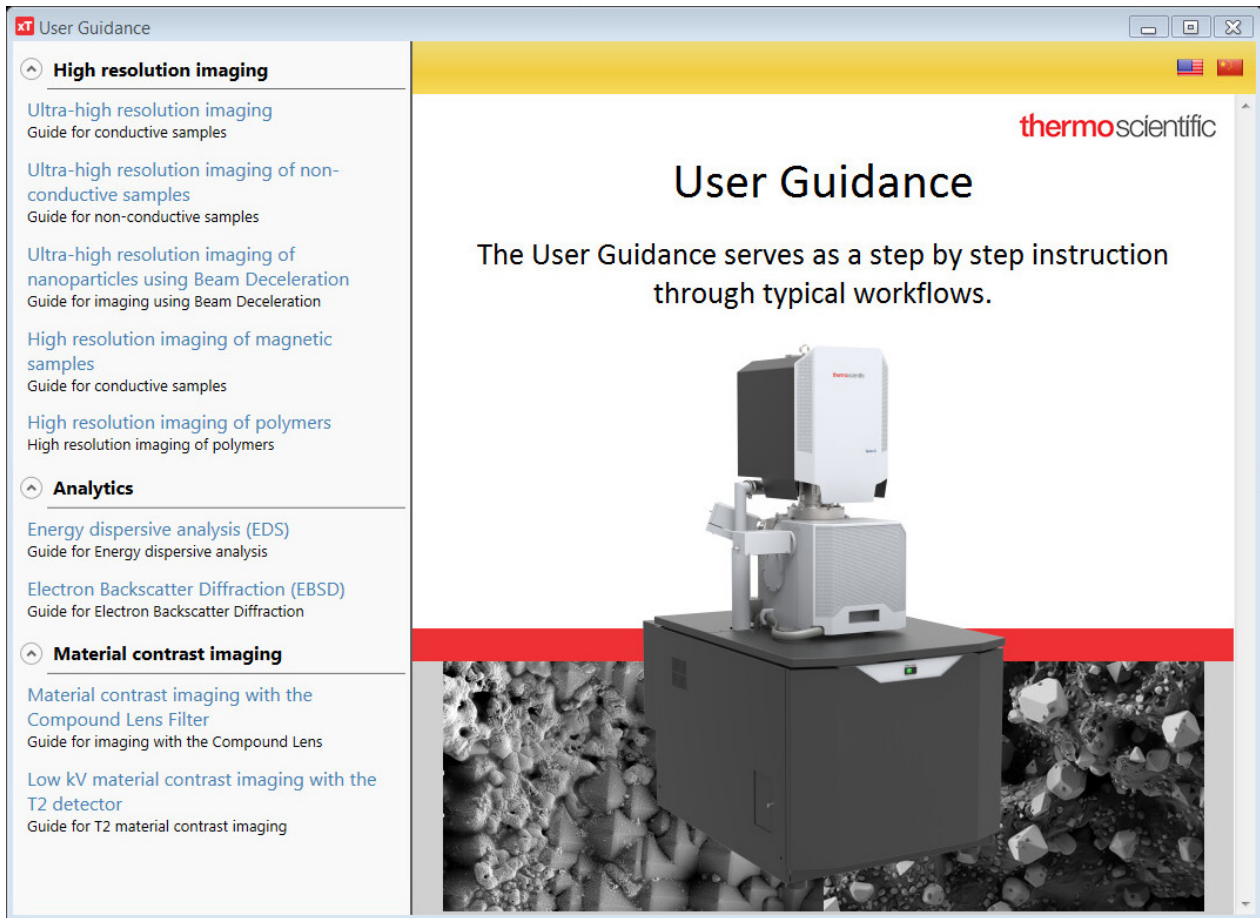
ENTERING COMMANDS - USING KEYBOARD			
Microscope Control (UI) Function & Specific Keys			
Key(s)	Function	Key(s)	Function
<b>F1</b>	shows documentation	<b>Ctrl + H</b>	sets Horizontal Field Width (HFW)
<b>Shift + F1</b>	shows Image properties	<b>Ctrl + K</b>	sets Spot mode conditions
<b>(Shift +) F2</b>	starts / stops Photo with an active beam (in all displays with the same beam at once)	<b>Ctrl + M</b>	sets Full Frame scanning conditions
<b>Ctrl + (Shift +) F2</b>	starts / stops Active Preset Snapshot (from all displays at once)	<b>Ctrl + Shift + M</b>	starts movie recording
<b>(Ctrl+) F3</b>	toggles Videoscope On / Off (in all displays)	<b>Ctrl + N</b>	toggles Sample Navigation On / Off
<b>Shift + F3</b>	starts Home Stage procedure	<b>Ctrl + O letter / +Alt + S</b>	opens Preferences dialogue / Preferences Scanning item
<b>F4</b>	starts / stops electron imaging Snapshot from active display	<b>Ctrl + P</b>	opens Print dialogue
<b>Shift + F4</b>	starts / stops Lens Alignment procedure	<b>Shift + P</b>	proceeds with next pattern
<b>F5</b>	toggles Single / Quad Image mode	<b>Ctrl + R</b>	restarts scan
<b>Ctrl + F5</b>	toggles Large Image Window mode On / Off	<b>Ctrl + (Shift +) S</b>	saves image(s) (from all displays)
<b>Shift + F5</b>	toggles Center Cross On / Off	<b>Ctrl + Y</b>	redoes last operation
<b>F6</b>	pauses / releases scanning	<b>Ctrl + Z</b>	undoes last operation
<b>Shift + F6</b>	toggles Alignment rectangle On / Off	<b>Ctrl + Shift + Z</b>	starts Take Nav-Cam Photo procedure
<b>F7</b>	toggles Reduced Area On / Off	<b>(Ctrl +) Pause</b>	starts / stops (/ resets) patterning
<b>Ctrl + F7</b>	starts Image Post Processing	<b>Ctrl + (Shift +),</b>	sets one step slower (preset slow) scanning
<b>F8</b>	starts Degauss procedure	<b>Ctrl + (Shift +),</b>	sets one step faster (preset fast) scanning
<b>(Shift +) F9</b>	starts Auto Contrast and Brightness procedure (in all active displays)	<b>Ctrl + (Shift+) Tab</b>	activates displays stepwise (backward)
<b>(Ctrl +) F11</b>	starts Auto Focus (Auto Stigmator) procedure	<b>Ctrl + Page Up / Down</b>	switches within control pages stepwise
<b>Shift + F11</b>	toggles Display Saturation tool On / Off	<b>Ctrl + 1 / 2 / 3 ...</b>	selects the particular page - the number corresponds to the toolbar page icon sequence
<b>(Shift +) F12</b>	toggles Compucentric (Scan) Rotation tool On / Off	<b>(Ctrl +) + / - keypad</b>	increases / decreases the magnification 2x (Digital Zoom)



**User guidance**

This pop-up window contains detailed instructions about some complex procedures and/or settings.

**FIGURE 3-12: User Guidance**



**About Microscope Control**

The window containing information about the product version is shown. It automatically disappears after the first click anywhere.



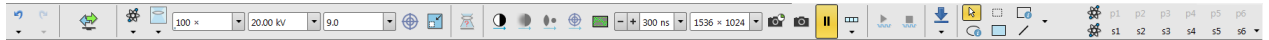
xTm Copyright © Thermo Fisher Scientific 1999-2018  
 Uses XJ Charts © XJ Technologies.  
 Contains software or other content adapted from  
 Smart Client – Composite UI Application Block  
 ©2005 Microsoft Corporation. All rights reserved.

<b>Microscope Version</b>	<b>13.x</b>
XT Platform Version	13.5.0.6003
XT UI Version	13.5.0.3469
Serial Number	D-SIMULATION
Machine Type	Aprco

**RESTRICTED RIGHTS**  
 Contractor: Thermo Fisher Scientific, 5350 NE Dawson Creek Drive, Hillsboro, OR 97124 The U.S. Government has restricted rights to use, modify, reproduce, release, perform, display or disclose this Thermo Fisher Scientific software as specified in Thermo Fisher Scientific's standard commercial software license agreement and as provided in DFARS 227.7202, FAR 52.227-19 and FAR 12.212

## Toolbar

The toolbar shown below the Menu bar is made up of functional graphical elements (icons, adjusters, etc.) linked to the most frequently used system controls.



**Note**

The default workspace is described here, for custom settings see corresponding sections of this manual.

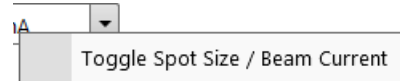
Rest the cursor over the icon for two seconds without clicking on it to see its explanatory tooltip. Right-clicking on some toolbar icons calls up a context menu with other functionality choices. For instance, a user can move directly to the *Preferences* setting (by clicking on the *Edit* item) or to change a mode of value depiction.



Whenever a function is selected, the corresponding icon is highlighted (orange background) to indicate the function is active.

**Note**

If any icon represents a menu function, refer to the corresponding menu for its description.



## Undo / Redo

The undo / redo buttons assist undoing / re-running the last actions. Actions used in history are accessible by clicking the down arrow. They can be re-used separately, or any continuous sequence of actions can be selected and re-used as a group.



**Note**

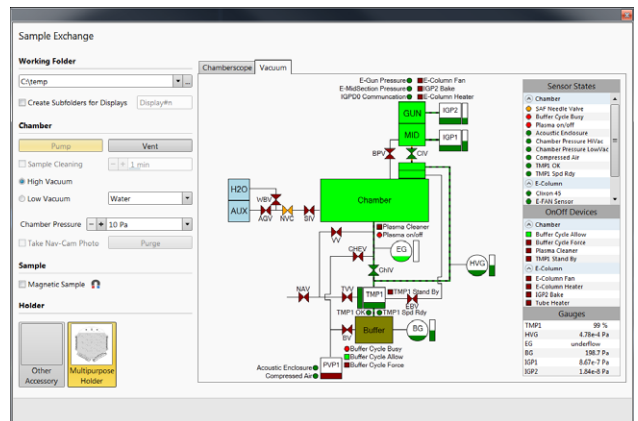
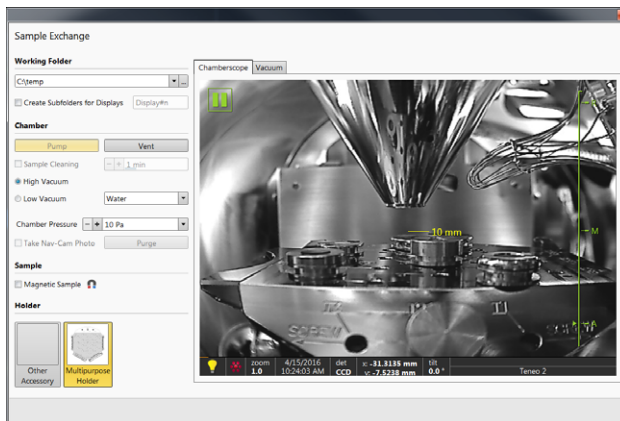
Some particular actions (alignments etc.) cannot be undone, and sometimes the system clears the history of actions.

## Sample exchange

The window contains controls for sample exchanges, working conditions and start-up actions settings and information about the system vacuum status (see Chapter 5):



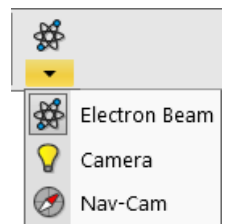
- The *Working Folder* for images storing with a possibility to *Create Subfolders for Displays*
- Setting *Sample Cleaning* when pumping the chamber down
- Selecting Vacuum modes (*High Vacuum / Low Vacuum*) and associated parameters
- *Take Nav-Cam Photo* automatically
- Starting the sample chamber *Purge* process
- When processing a *Magnetic Sample*, ticking this check box prevents the *Immersion lens* and *Compound Lens Filter* to be switched on.
- *Stage Holder* selection



## Electron beam / Camera / Nav-Cam

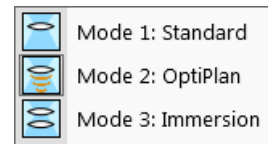
Selecting an item from the drop down list makes the display or single screen show the *Electron Beam / Camera / Nav-Cam* imaging with respect to the source, column, scanning, and detector settings. Only one is selected at any given time, but they can be operated independently for each display.

Another way to change the beam for a particular imaging is clicking on the image databar beam icon.



### Column Use cases

The electron column can be operated in different column Use cases optimized for specific applications. Selecting a desired Use case can be done with the *toolbar / Use case* drop down list box and also within the Use Case module (see Chapter 5).



### Magnification (HFW) / High voltage / Spot size (Beam current) list boxes

Click on the list box to expand a list of pre-set and allowed values. Choose one by clicking on it; it is applied immediately (see the *Preferences / Presets* section).

- The *Spot* is defined as the actual electron beam diameter on the specimen surface. It is expressed by a relative number. The optional way (representable in the toolbar) to express the Spot is the electron beam current value. (see the *Preferences dialog / General* section / *Beam current control* item). Both physical quantities are related. The electron beam current shown in the toolbar list box (and optionally in the image databar) is approximate and is valid only if the microscope is well-aligned.

50 ×	1.00 kV	8.0
100 ×	500 V	1.0
500 ×	1.00 kV	2.0
1000 ×	2.00 kV	3.0
5000 ×	5.00 kV	4.0
30000 ×	10.00 kV	5.0
100000 ×	20.00 kV	6.0
250000 ×	30.00 kV	7.0
300000 ×		8.0
1.036 μm	0.10 nA	9.0
9.000 μm	0.78 pA	10.0
500.0 nm	1.6 pA	11.0
1.000 μm	3.1 pA	12.0
5.000 μm	6.3 pA	13.0
15.00 μm	13 pA	14.0
30.00 μm	25 pA	15.0
150.0 μm	50 pA	16.0
300.0 μm	0.10 nA	17.0
1.500 mm	0.20 nA	18.0
	0.40 nA	

### Imaging pixel resolution list box

This list contains the available imaging pixel resolutions (also used for captured images). Selecting a new resolution results in the immediate change of the scanning raster. Since the present dwell time remains unchanged, the actual scanning frequency (both Line and Frame time) changes.

768 x 512
768 x 512
1536 x 1024
3072 x 2048
6144 x 4096
512 x 442
1024 x 884
2048 x 1768
4096 x 3536

### Patterns / Measurements / Annotations

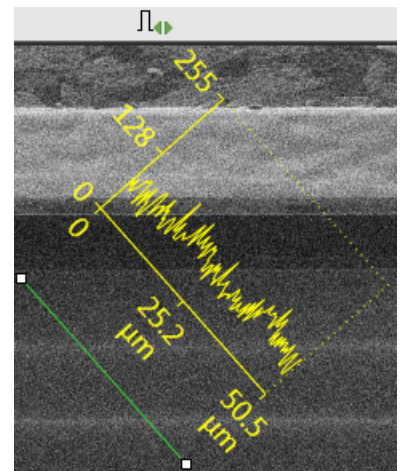
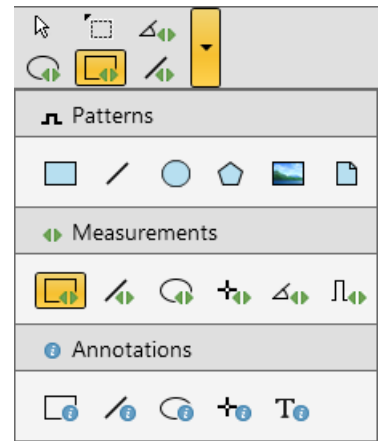
There are 2 pointers (from top left): the normal cursor (white arrow) and the selection cursor (gray rectangle - all objects included within its area are selected). Other icons represent the four shapes that were most used recently.

Clicking the down arrow reveals more shapes and enables quick access to the *Patterns / Measurements / Annotations* tool. Clicking on the icon activates (orange background) / deactivates (gray background) the appropriate functionality.

To deactivate the drawing mode at any time press the Esc key (keyboard).

The numerical values of linear distances, diameters, angles, or areas of the image are updated during drawing and are shown alongside of or within the finished measured item. The Measurement tool dimensions scale with the image; when changing magnification, the tools shown change their size accordingly. In contrast, the Annotation shapes and texts have their sizes fixed relatively to the display.

The *Measurements / Intensity profile* delineates the imaging profile across a freely drawn line.



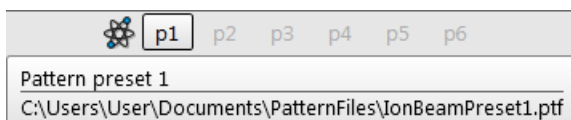
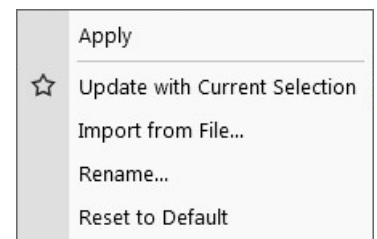
### Pattern presets

By default there are 6 empty toolbar *Pattern presets* (labeled *p#*). Any pattern preset can be assigned to an individual .ptf file with all patterning parameters exported via the *File menu / Export / Patterns* item. Clicking on any pattern preset loads its parameters from this file, and corresponding patterns are drawn in the active display. To start patterning under loaded conditions, follow the patterning process.



Right-clicking on any Pattern preset button calls up the context menu:

- Clicking on the *Apply* item (the same as clicking the button directly) loads parameters from this file and corresponding patterns are drawn in the active display. To start patterning under loaded conditions follow the patterning process.
- Clicking on the *Update with Current Selection* item assigns patterns directly from the active display, saves the setting to the file and automatically applies it to the selected preset button. Tooltip shows the location and a file name.



- Any toolbar Pattern preset button can be assigned to an individual .ptf file (with all patterning parameters exported via the *File menu / Export / Patterns* or *System Parameters* item) by selecting *Import from File* item.
- To rename the pattern preset button click the *Rename* item.
- Clicking on the *Reset to Default* item brings all settings to the factory presets.



## Scanning presets

By default, there are 6 factory toolbar *Scanning presets* (labeled *s#*). Clicking on any one starts image acquiring with the corresponding parameters.

Right-clicking on any Scanning preset button calls up the context menu:

Activate	Click
Multiple Activate	Shift + Click
Snapshot	Ctrl + Click
Multiple Snapshot	Ctrl + Shift + Click
☆ Update with Current Settings	
Edit...	
Import Scanning Presets...	
Export Scanning Presets...	
Reset to Default	



**Scanning presets** [X]

**Basic Setup**

Name	SDD-Navigate
Resolution	1536 × 1024
Dwell Time	5 μs
Bit Depth	16 bit

**Filter Setup**

Scan Interlace	1
Line Integration	6
Frame Average	1
Frame Time	00:00:47

**Image Acquisition**

Integrate	1
Drift Correction	Yes
Continuous Scan	No
Action	None
Acquisition Time	00:00:47

**Shared Settings**

Mains Lock	No
Start scan on left click	Yes

Close

- Clicking on the *Activate* item highlights the button (orange background) and starts image acquisition, or just activates the preset according to the *Scanning presets* property editor / *Shared Settings* section / *Start scan on left click* item setting (Yes / No). The *Multiple Activate* item has the same functionality in all compatible displays (same beam).

Starting image acquisition is also possible using the *Scan* menu / *Active Preset Snapshot* (Ctrl + F2) item.

- Clicking on the *Snapshot* / *Multiple Snapshot* item starts snapshot acquisition from active / all compatible displays.
- Clicking on the *Update with Current Settings* item updates the selected Scanning preset with the actual scanning settings.
- Clicking on the *Edit* item opens the selected Scanning preset property editor. It is also possible to use the toolbar down (expand) / up (hide) arrows with the same effect.
- It is possible to *Import* / *Export Scanning Presets* from / to a file (.scp).
- Clicking on the *Reset to Default* item brings all settings to their factory presets.

A tooltip is shown when the mouse cursor hovers over any preset button, giving the parameters overview. The parameters colors indicate:

- Green: actual microscope setting matches the column preset
- Dark red: actual microscope setting differs from the column preset
- Gray: Value is not relevant when the respective component is switched off

LiSlowScan\_002

**Basic Setup**

Resolution: 1536 × 1024  
Dwell Time: 100 ns  
Bit Depth: 8 bit

**Filter Setup**

Scan Interlacing: 1  
Line Integration: 100  
Frame Average: 1  
Frame Time: 00:00:16

**Image Acquisition**

Integrate: 1  
Drift Correction: Yes  
Continuous Scan: No  
Action: Save As  
Acquisition Time: 00:00:16

**Shared Settings**

Mains Lock: No  
Automatic Start: Yes

## Imaging area

The Microscope Control software (UI) uses 4 independent displays for imaging samples. Each display can contain images from any detector (including External and CCD), paused imaging or images loaded from a file. Additionally, display 3 can show a mix of images from displays 1 and 2, and display 4 can show a mix of images from displays 1, 2 and 3.

The Quad image and Single image modes are available. The *Quad Image* mode shows 4 displays at the same time. The *Single Image* mode shows one display over the UI imaging area.

Each display consists of its imaging area, an adjustable Databar containing the imaging parameters, a selectable overlay (user-defined coloring, annotations, measurements) and some status icons (Pause, Sample Navigation, etc.).

At any one time, just one display is active (has focus), and all functions related to it (Pause, Sample Navigation, image processing) apply only to imaging on this display. The active display is marked by the highlighted (blue background) Databar and optionally also by a blue frame (see *Preferences / General*).

Depending on the display content and the status, some mouse functions are available over its area:

- *Electron imaging* (incl. External and Mix): focus, astigmatism correction, Beam Shift, magnification change (coarse, fine), zoom (in / out), Contrast & Brightness, lens alignment, Scan / Compucentric Rotation, XY-move (get or track mode)
- *Optical imaging*: 10 mm Marker placement, Compucentric Rotation, Z-move (track), Tilt, Working distance indicator

Optical imaging is automatically activated (if it is paused) when the venting procedure starts. When it is paused and any stage movement takes place, the pause icon turns red, and a list of changed axes is shown.



**Note**

Due to hardware limitations, some detectors cannot be used simultaneously. They can still be selected for different displays at the same time, but if one of them is started, other imaging with the incompatible detector is automatically paused.

## Image databar

Optional instrument, imaging and labeling information are shown at the base of all displays. The configuration and available items differ for the beam selected (Electron / Optical / Nav-Cam) for the active display.

**FIGURE 3-13:** Databar examples

	11/4/2014 3:22:52 PM	dwel 300 ns	HV 20.00 kV	pressure 5.37e-4 Pa	HFV 2.47 mm	 Teneo	Active electron display
	11/4/2014 3:22:52 PM	dwel 300 ns	HV 20.00 kV	pressure 5.37e-4 Pa	HFV 2.47 mm	 Teneo	Inactive electron display
	11/4/2014 3:26:40 PM	det CCD	x: 0.0000 mm y: 0.0000 mm	tilt 0.0 °	Not Calibrated Teneo		Inactive optical display
	11/4/2014 3:37:15 PM	dwel 300 ns	HV 20.00 kV	pressure 5.25e-4 Pa	HFV 2.47 mm	 Teneo	Active Patterning display
	11/4/2014 3:37:15 PM	dwel 300 ns	HV 20.00 kV	pressure 5.25e-4 Pa	HFV 2.47 mm	 Teneo	Inactive Patterning display
	11/4/2014 3:23:19 PM	x: 0.0000 mm y: 0.0000 mm	HFV 85.0 mm	det Nav-Cam	 Nav-Cam		Inactive Nav-Cam display (option)

**Note**

The Databar information always relates to the live imaging. If imaging is paused or an image is loaded from a file, the information can differ from what is in the actual system conditions.

Clicking on some of the image databar fields induces an active menu related to it with appropriate choices.

Clicking on the label field brings up the label-editing menu.

Double-clicking on the micron bar induces the Image properties window showing multiple parameters at which an image was captured. The same functionality is caused by pressing the Shift + F1 keys.

To set which information is included in the databar right-click on any display databar and click on & drag the desired *Available Item* to the *Visible Items* field. Items can be placed in any order (by dragging items up / down within the list). They expand or contract automatically to fit the display width as long as there is enough room. This influences all displays with the same beam.

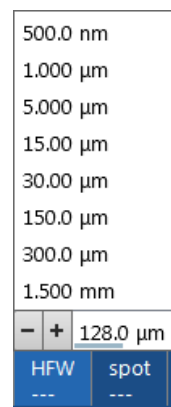
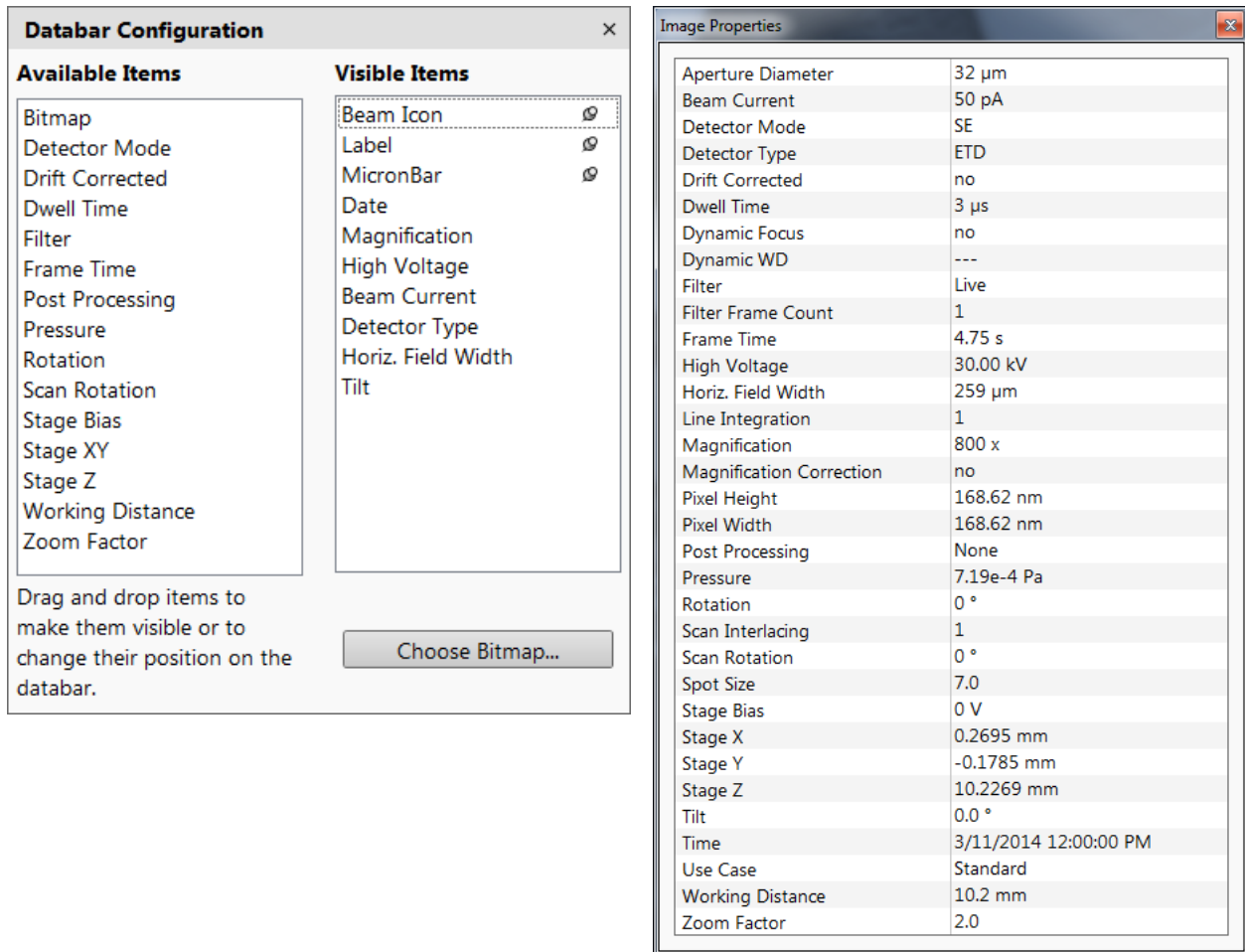


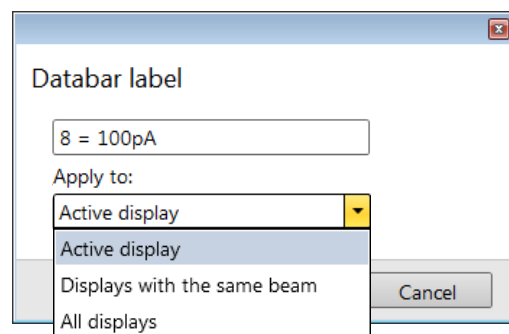
FIGURE 3-14: Databar configuration / Image properties



To label a databar, double-click on the Label field and fill in the dialog. It can be set independently for each display.

The *Micronbar* area scales to the magnification.

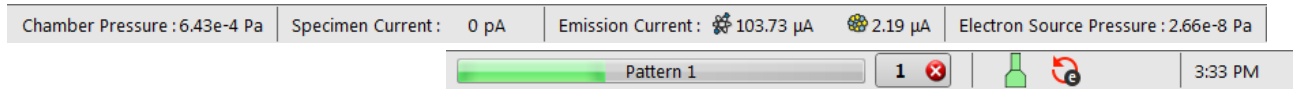
Clicking on the *Choose Bitmap* item opens a dialog to choose a bitmap to be loaded into the databar (if the *Bitmap* item is ticked).



## Status bar

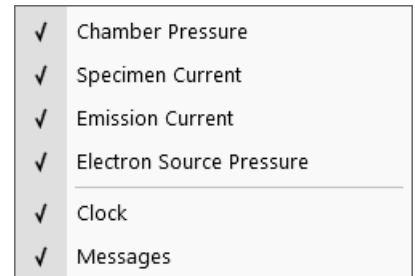
The Status bar can be found at the base of the UI screen. It contains several user selectable items along with information about running system processes (for instance, patterning).

**FIGURE 3-15:** Status bar (divided into left / right part)



Right-click on the Status bar and check items to be shown:

- *Chamber Pressure* – the specimen chamber pressure
- *Specimen Current* – the electron current reaching the specimen
- *Emission Current* – the electron current leaving the source
- *Electron Source Pressure* – pressure in the corresponding vacuum system section
- *Clock* – can be shown at the bottom right window corner
- *Messages* – Application Status incoming notices can be shown

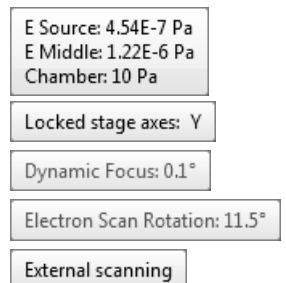


The system conditions are shown by means of the icons:

**Table 3-1** Status Icons









Icon	Status
	Source space vacuum / Chamber vented
	Source space vacuum / Chamber pumping or venting
	Source space vacuum / Chamber vacuum (ready for the microscope operation)
	Stage axes locked (any one)
	Dynamic focus is on
	Tilt correction is on
	Scan rotation is not zero
	External scanning mode is on

When you hover the mouse over any icon, a corresponding tooltip appears with either the actual status of the parameter(s) or just with information.



## Control pages and modules

The software controls on the right side of the screen are organized into *Control pages*, which are divided into *modules / tab modules* holding specific functions. The required page can be selected either by clicking on the corresponding icon or with the use of shortcuts (see further). The Control pages and modules available for the system are:

- **Beam control page** 
  1. Vacuum, 2. Column, 3. Magnification, 4. Compound Lens Filter, 5. Beam, 6. Beam Deceleration, 7. Scan Rotation, 8. Detectors
- **Navigation page** 
  9. Stage, 10. Stage Z, 11. Tilt Correction
- **Detectors page** 
  12. Detector Settings, 8. Detectors
- **Patterning page** 
  13. Patterning Control, 14. Properties, 15. GAS Injection (option - see Chapter 7)
- **Processing page** 
  14. Properties, 16. Digital Zoom, 17. Enhanced Image tab modules (LUT / Mix 3 / Mix 4 / Color / Process)
- **Direct adjustments page** 
  18. Direct Adjustments (Beam / Stigmator Centering / Focus), 8. Detectors
- **Column presets page** 
  19. Use Case, 20. Column Presets, 8. Detectors
- **Microscope alignments page** 
  21. Alignments (Instructions / Individual steps)

### Note

The number in front of the module name represents the order in which the modules are introduced in the following text.

Some of the module controls are beam-dependent. In this case, the actual beam type is indicated by the corresponding icon at the right-hand side of the module.



### 1. Vacuum module

This module is used to control the pressure in the specimen chamber. Clicking on the *Pump* button starts the pump-down procedure for the specimen chamber and the column. The system allows switching the accelerating voltage on only when the chamber is sufficiently evacuated. Clicking on the *Vent* button starts chamber venting for a sample or detector exchange after user confirmation.

Ticking the *Sample Cleaning* check box pumps the system, starts the Sample Cleaning procedure (duration can be set), and keeps the column pumped.

The Mode radio buttons bring the system to:

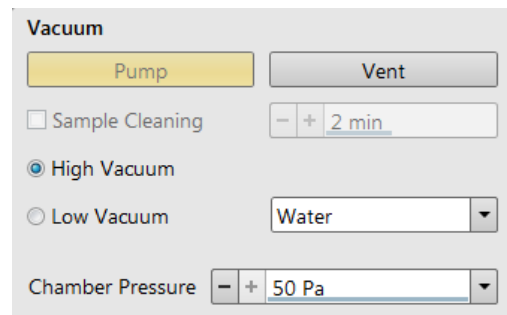
- the *High Vacuum* mode, which is the conventional operating mode (associated with all scanning electron microscopes). It is used for observing conductive specimens that can withstand low pressure conditions and do not release gas.

In this mode, the system pumps continuously to achieve the lowest possible pressure.

- the *Low Vacuum* mode is for observing non-coated and non-conductive or partially conductive specimens.

In this mode, the chamber pressure is controlled using the *Chamber Pressure* adjuster, while the column is at a much lower pressure. The gas environment can be selected from the list box.

The system automatically switches to one of the modes when the chamber is Vented and a dedicated detector is installed. If no dedicated detector is installed, the user is asked to determine a detector mounted by the *PLA accessories* dialog (see chapter 2).



## 2. Column module

contains the controls for setting the electron beam conditions:

### **Beam On button**

switches the accelerating voltage on (orange background) / off (gray button). If the source is not started (empty progress bar), this button starts the electron source first (green progress bar).

### **Beam current / Spot size adjuster**

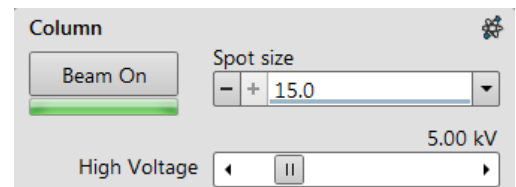
enables adjusting the electron *Beam current* / *Spot size* with adjustable accuracy (see the *Preferences / General* section). The actual value (from the factory preset list) is shown in the adjuster text area, toolbar and imaging databar (if selected). Only values applicable for actual imaging conditions are shown.

#### Note

The *Spot size* influences both the focused electron beam area and the *Beam Current*: the smaller the *Spot size*, the lower the *Beam Current*.

### **High voltage adjuster**

enables adjusting the overall electron beam accelerating voltage (from 200 V to 30 kV) either continuously or using the pre-set values (see the *Preferences / Presets* section). The actual High Voltage value is shown in the adjuster text area, toolbar and imaging databar (if selected).

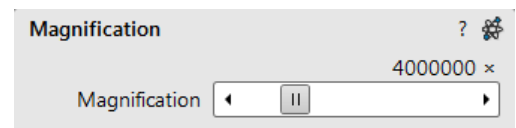


## 3. Magnification module

The adjuster offers a variety of ways to control imaging magnification. The magnification range changes dynamically according to the working distance and can also be controlled with the use of other tools.

### **Magnification control**

- Clicking on the *end right / left arrow* increases / decreases magnification by 5%.
- Clicking between *the right / left end arrow* and the *button* increases / decreases magnification by 20%.



## 4. Compound Lens Filter module

The compound lens filter uses the advantages of the compound final lens, that combines the magnetic final lens inside the pole piece, the immersion magnetic lens and the electrostatic lens formed by the potential at the T1 detector. Main function of the compound final lens is to focus the primary electron beam to the sample. However, independent control of these three lenses together with continuous control of the immersion lens enables to filter back-scattered (BS) electrons reaching the T1 detector. The compound lens filter behaves as a chromatic sensitive lens, which focuses the low energy BS electrons into the aperture of the annular T1 detector. The high energy BS electrons are less sensitive to the magnetic field and reach the T1 detector. Secondary electrons also pass through the aperture in the T1 and are collected further in the column by the T2 and T3 detectors.

The compound lens filter is available in the *OptiPlan* and *Immersion* Use cases with or without the Beam Deceleration. The main goal of the compound lens filter is the enhancement of the compositional contrast of the sample. Besides that, it can be successfully used for imaging of insulating samples without charging - secondary and low energy BS electrons which are most sensitive to charge are filtered out from the T1.

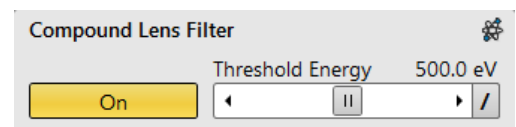
When clicking the *On* button the *Threshold Energy* slider becomes active to define threshold energy of BS electrons - energies lower than threshold are filtered out and don't contribute to the T1 signal, energies higher than threshold contribute to the T1 signal. The filter functionality is also visible within the image databar via the *Threshold* item and via the *Detector type* item - T1.

The compound lens filter works ideally at low landing energies - 5 keV and less. Typical imaging conditions are:  
WD = 4 mm / Landing Energy = 1 keV / Beam current = 100 pA / Threshold Energy = 500 eV

Start imaging with the T1 detector with the *OptiPlan* Use case, activate the filter and gradually increase the *Threshold Energy* - T1 imaging gets dark as the lower energy backscattered electrons are filtered out of the detector surface. The filter can be applied also with the *Immersion* Use case; in this case the starting *Threshold Energy* is maximal.

#### Caution!

*Magnetic samples must not be used (see Sample exchange above), otherwise it can be torn away from the holder and stuck to the final lens pole.*



## 5. Beam module

### Stigmator 2D control

enables correcting of image astigmatism. The crosshair indicator indicates the actual setting.

Shift + Right-clicking on an imaging display triggers astigmatism correction. Unlike the 2D box control, this is magnification-sensitive and is therefore suited for fine corrections at high magnifications, or for employing the Adaptive Sensitivity functionality.

### Beam Shift 2D control

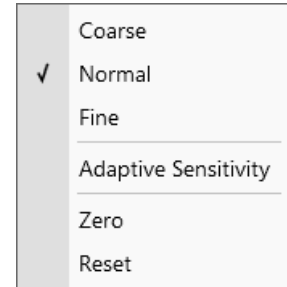
indicates and controls the beam shift with respect to the objective lens axis. It is useful for fine imaging shifts without stage movement.

Shift + Clicking on an imaging display triggers the Beam Shift function. The standard mouse cursor changes to the "hand" cursor, and the imaging can be dragged on the screen. Because of a limited Beam Shift range, this works well only for high magnifications or when employing the Adaptive Sensitivity functionality.

#### Note

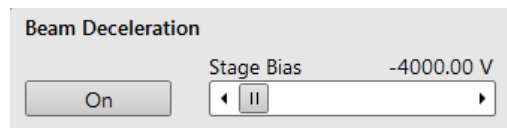
Right-clicking on the 2D box opens a context menu with the following choices (for more, see *Software Interface Elements / 2D Controls*):

- The **Reset** sets the Beam Shift value to zero and moves the stage to compensate for the resulting imaging shift (same as the *Stage menu / Beam Shift Reset* function).



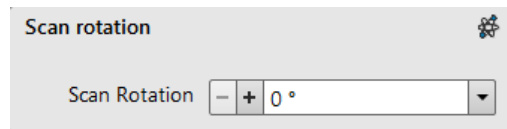
## 6. Beam Deceleration module

In the *Beam Deceleration* mode (option), a negative potential *Stage Bias*, is applied to the stage, which influences both primary and detected electrons. This functionality is standard for biases ranging from -50 V to +50 V. There is an option for biases ranging from -4 000 V to +50 V.



## 7. Scan rotation module

controls and shows the Scan Rotation value.



## 8. Detectors module

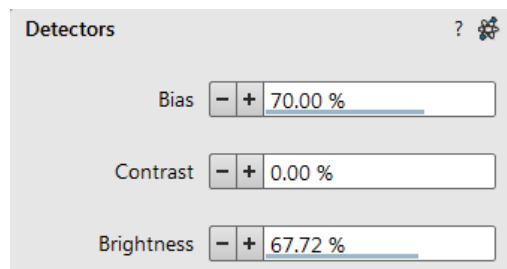
contains adjusters to control the actual detector *Contrast* (electronic gain) and *Brightness* (voltage offset). The values are remembered for each detector. The adjusters are disabled if the detector is not available or cannot be controlled (e.g. CCD camera or an External detector).

### Contrast / Brightness / Enhance adjusters

Regardless of the detector's actual gain range, the Contrast & Brightness range is always 0 - 100 (%) and the small / large step size is 0.1 / 1 (the Brightness step size may differ for some detectors in order to achieve sufficient sensitivity). A direct value can be entered by double-clicking on the Contrast / Brightness value.

Ctrl + clicking on while left-right / up-down dragging within an imaging display controls the Contrast / brightness.

The Low Vacuum detectors could have specific controls within the *Detectors* module.





### 9. Stage module

consists of elements enabling:

- showing the numerical values of a particular position;
- showing the stage positions locations in a visual map form and as a list for selection;
- navigating across the sample surface.

*Note*

*The stage movement can be aborted by pressing the keyboard Esc key. Don't hesitate to do so if you are not sure that the initiated movement is safe!*

**Stage**

Actual Go To

X  ↕

Y  ↕

Z +↕  ↕

T  ↕

R  ↕

Compucentric Rotation  Z-Y Link

Last Position

FC

smallSpheres

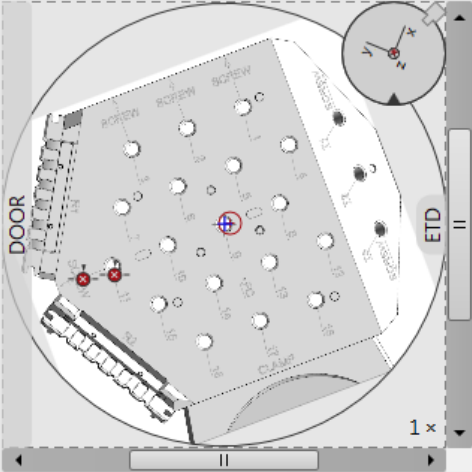
Add

Update

Remove

Remove All

Touch Alarm Enabled



### 10. Stage Z module

This module enables slowly moving the stage in the Z-axis direction. The more the slider is pushed to the each side, the faster the stage motion will be. Clicking on the slider bar moves the stage by small steps.


**Stage Z**

Down Up



### 11. Tilt Correction module

This module enables correcting the imaging distortion when tilting the stage.

**Tilt Correction** 

Dynamic Focus  Tilt Correction

Tilt Angle

---

0.0 °

Manual

---

0 °

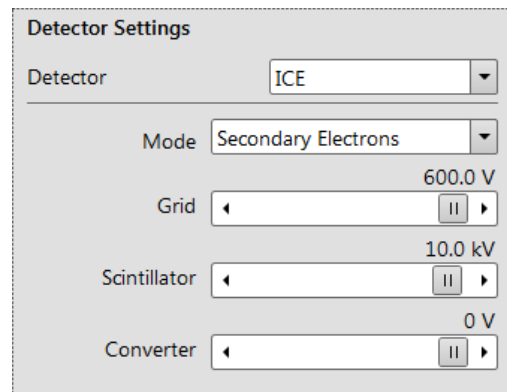
Specimen Pre-tilt

## 12. Detector Settings module

enables choosing the active display detector and adjusting its parameters.

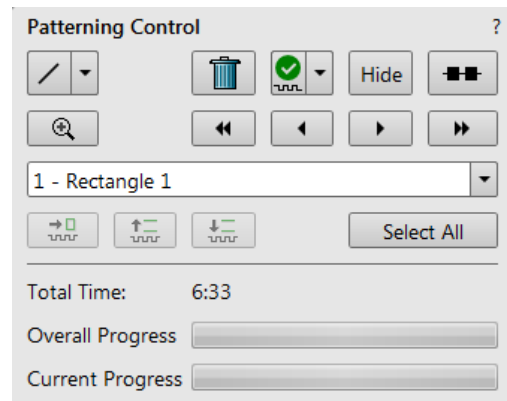
The *Detector* list box contains the list of detectors actually available for the active display (the same as the enabled items in the Detectors menu). The detector actually used in the active display is always shown.

The rest of the module dynamically changes according to the selected detector and its parameters, which may change from display to display.



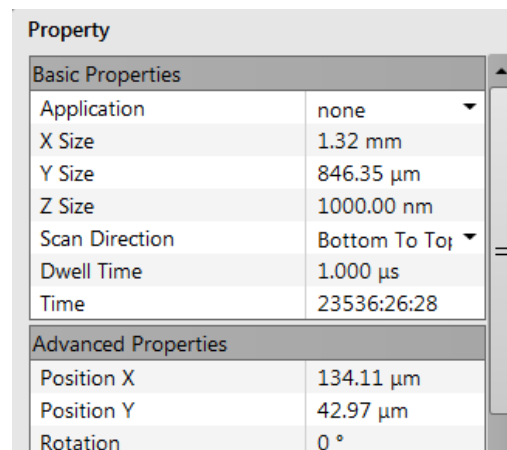
## 13. Patterning Control module

A pattern type can be selected and handled by using the icon buttons at the top of the module. It can be drawn in the active display; it is then shown in the pattern list with a number. The pattern properties can be changed via the *Property* module. The *Progress* indicator shows the *Overall / Current (pattern) Progress* (over time) of the actual patterning.



## 14. Properties module

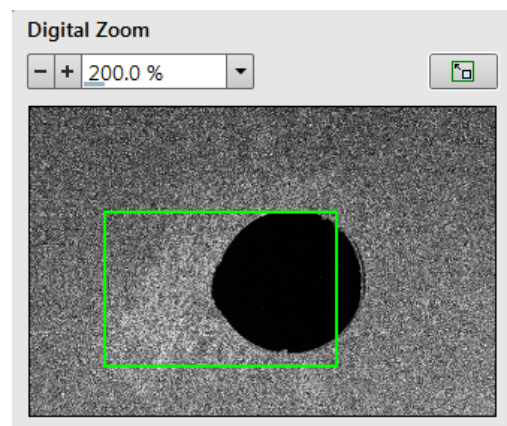
Some features (Measurements, Annotations, Patterns) require an individual set of parameters which are editable within this module, by clicking on the edit field or the down arrow to choose a value.



## 16. Digital Zoom module

This procedure takes place in computer memory only and helps navigate across the enlarged view. Click on the + / - button to enlarge / reduce the view in an active display or to select a zoom factor from the drop-down list. Click on the *Undo* button at the top right side of the module (visible only when applicable) to switch between the digital magnification last used and the normal view.

Click on & drag the green bordered area inside the Digital Zoom image, or move it by *Ctrl +* keyboard arrows, to change the observed area in the active display. Change the observed area by dragging the green borders. Press the *Ctrl + + / -* keyboard button to enlarge / reduce imaging in the active display. When digital zoom is applied, the magnifying glass icon appears in the appropriate display.

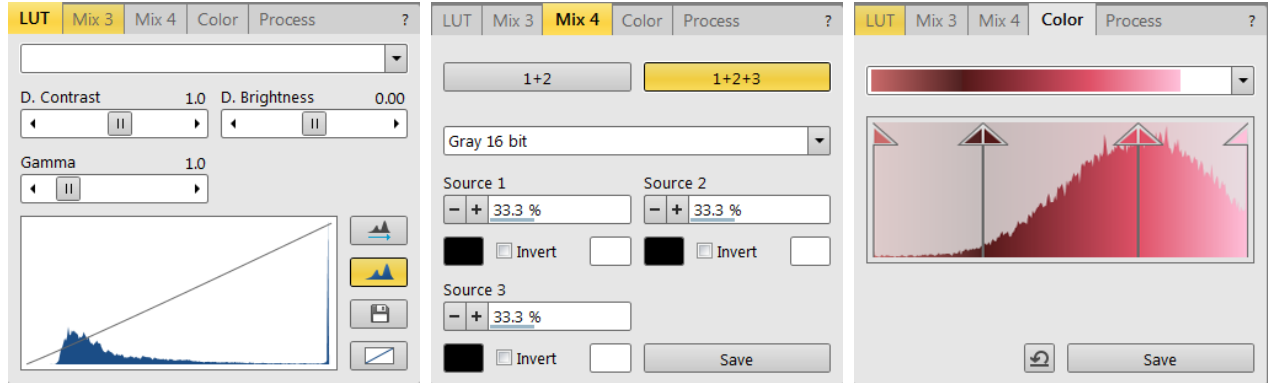


### 17. Enhanced image tab modules



consists of tabbed sections offering various digital image enhancements (in contrast to the *Detector* module / *Contrast & Brightness* functionality). These enhancements are applied only to the active display, independently of any other. In case a user changes the default settings of the *LUT* / *Color* / *Process* tab, its background changes to orange. The digital processing can be applied to any live, paused or loaded image, including an optical one (see Chapter 5).

FIGURE 3-16: Enhanced image module

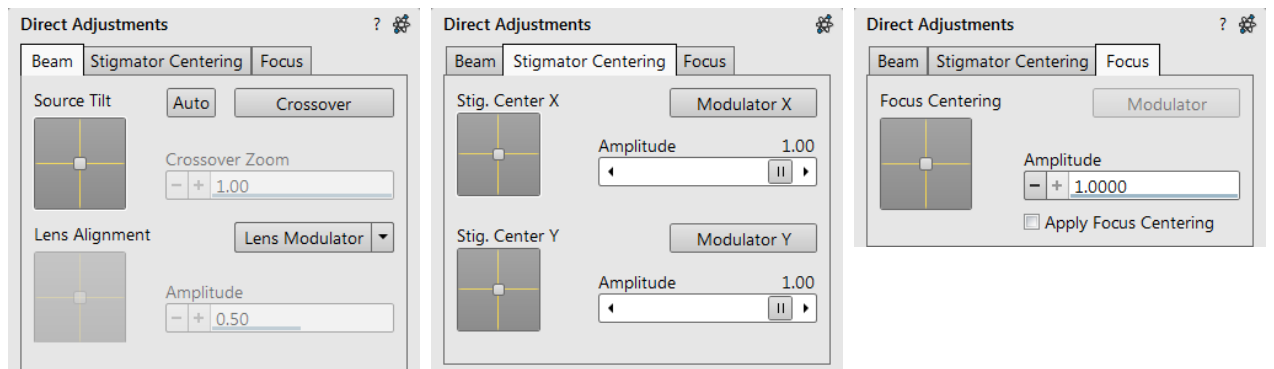


### 18. Direct Adjustments module



This control page serves for fine-tuning of beam geometry to achieve the best focus and brightness (see Chapter 5).

FIGURE 3-17: Direct Adjustments module



### 19. Use Case module



Use the drop down list box to select the desired *Use Case* for the specific application (see Chapter 5).



Note

In addition to restoring the factory Column presets, this function also sets some other microscope parameters.

## 20. Column Presets module

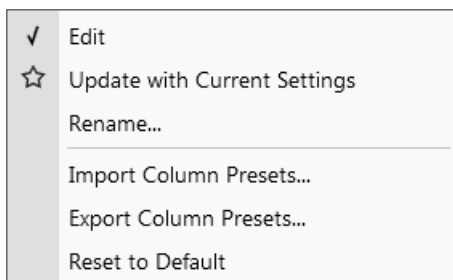


*Column Presets* in combination with Use cases (see above) simplifies microscope operation for users. The microscope software comes with pre-defined sets of various column parameters for the actual beam and Use cases represented by the Column presets buttons labeled *c#*. A user can change these settings to easily choose the operating conditions according to his needs.

The column preset is applied with a click. A progress dialog is shown. The button becomes highlighted (orange background) when all actual microscope settings match the preset parameters. The bold labeled button indicates the last applied column preset. Note behaviors that are not obvious:

- Beam is not switched on automatically when a column preset is applied.
- It can happen that a column preset cannot be completely applied because it is not possible to set some parameter (a particular detector might not be available, or a stage bias value might be out of range). In such cases an application status error message is shown.
- Tooltip dialog / *Detector settings* contains information in the format <detector>, <detector mode>. Particular settings for a detector custom mode are not supported in column presets.
- *Mix* detector cannot be used for a column preset.

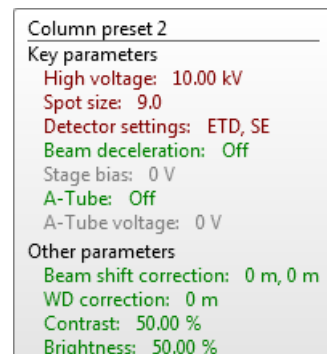
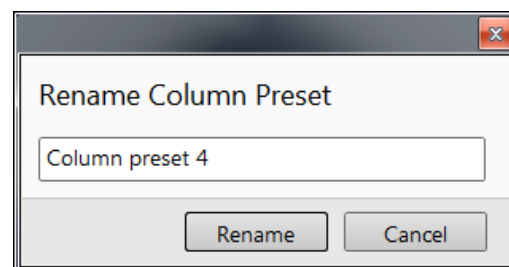
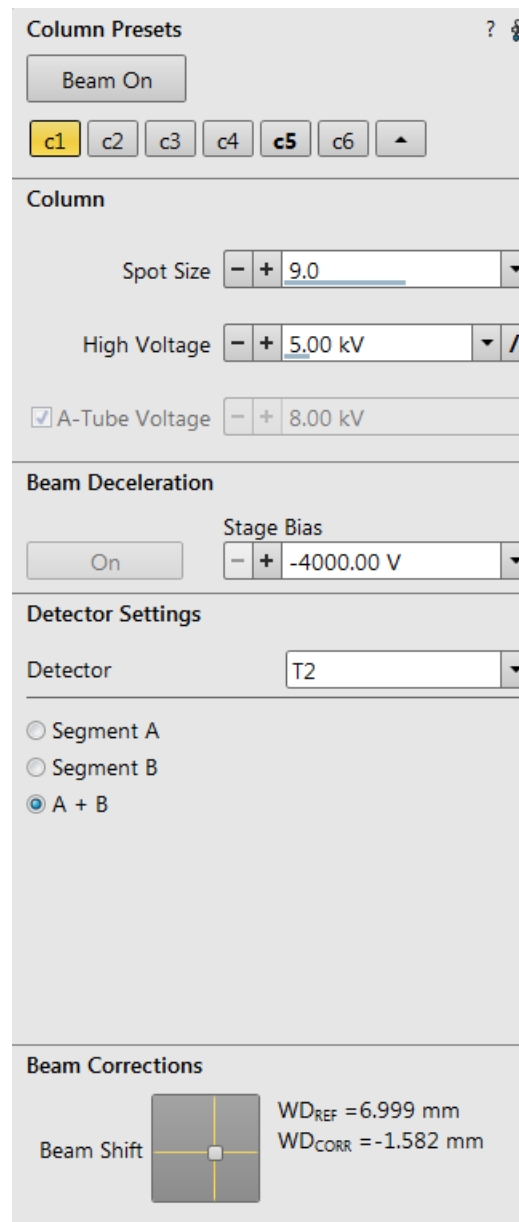
Right-clicking on any preset button calls up the context menu:



- Clicking on *Edit* opens the selected preset button properties for editing with sections for *Column* / *Beam Deceleration* / *Detector Settings* / *Beam Corrections*. It is also possible to use the down (expand) / up (hide) arrows next to the preset buttons with the same effect.
- Clicking on the *Update with Current Settings* item updates the selected preset button with actual settings.
- Clicking on the *Rename* item allows renaming of the selected preset button.
- It is possible to *Import* / *Export Column Presets* from / to a file (.clp).
- Clicking on the *Reset to Default* restores the default settings for all column presets (for both beams and for all use cases).

A tooltip is shown when leaving the mouse cursor over any preset button. The tooltip gives a parameters overview divided into 3 areas (*Preset name* / *Key parameters* / *Other parameters*). The parameters are colored. Color indications are:

- Green - actual microscope setting matches the column preset
- Brown - actual microscope setting differs from the column preset
- Gray - Value is not relevant when the respective component is switched off



## 21. Alignments module

contains alignments that enable optimizing system performance (see Chapter 4).

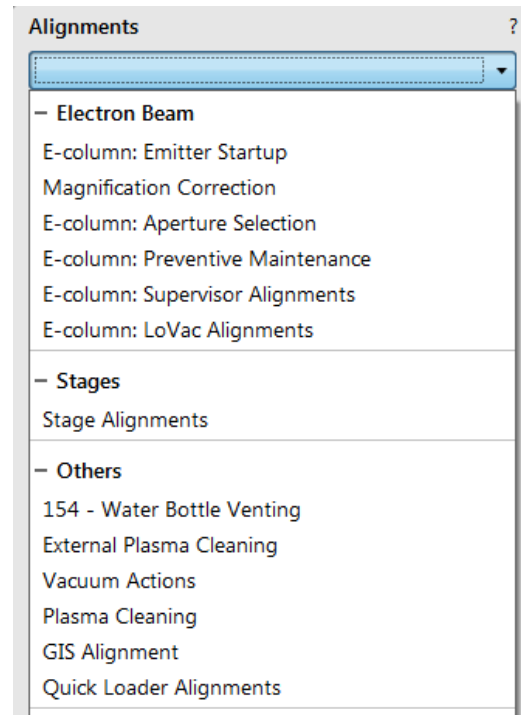
The list box contains a list of Alignment procedures available for the actual user level (User, Supervisor or Service).

### **Caution!**

*A user must understand the procedures at the appropriate level before proceeding with any adjustment. Improper alignments can make the system difficult to use.*

### Note

*Some alignment modules may have some features distributed differently than others, but their functionality is the same unless otherwise explicitly stated.*



## Preferences dialog

This dialog can be opened by selecting *Preferences* from the pull-down menus: *Scan* (*Ctrl + Alt + S*) and *Tools* (*Ctrl + O - letter*). The *Ctrl + O* shortcut opens this dialog on the last used item.

The Preferences dialog consists of sections listed on the left side of the window. The menu chosen dictates which section is opened on entry.

Once the Preferences dialog is opened, any section can be chosen. Clicking on a required section opens it and allows changing and presetting conditions for a group of related functions. The items changed remain valid for a specific user when logged on next time.

Some of the preference controls are beam dependent. In this case, the actual beam type is indicated by its corresponding icon, and controls change accordingly.



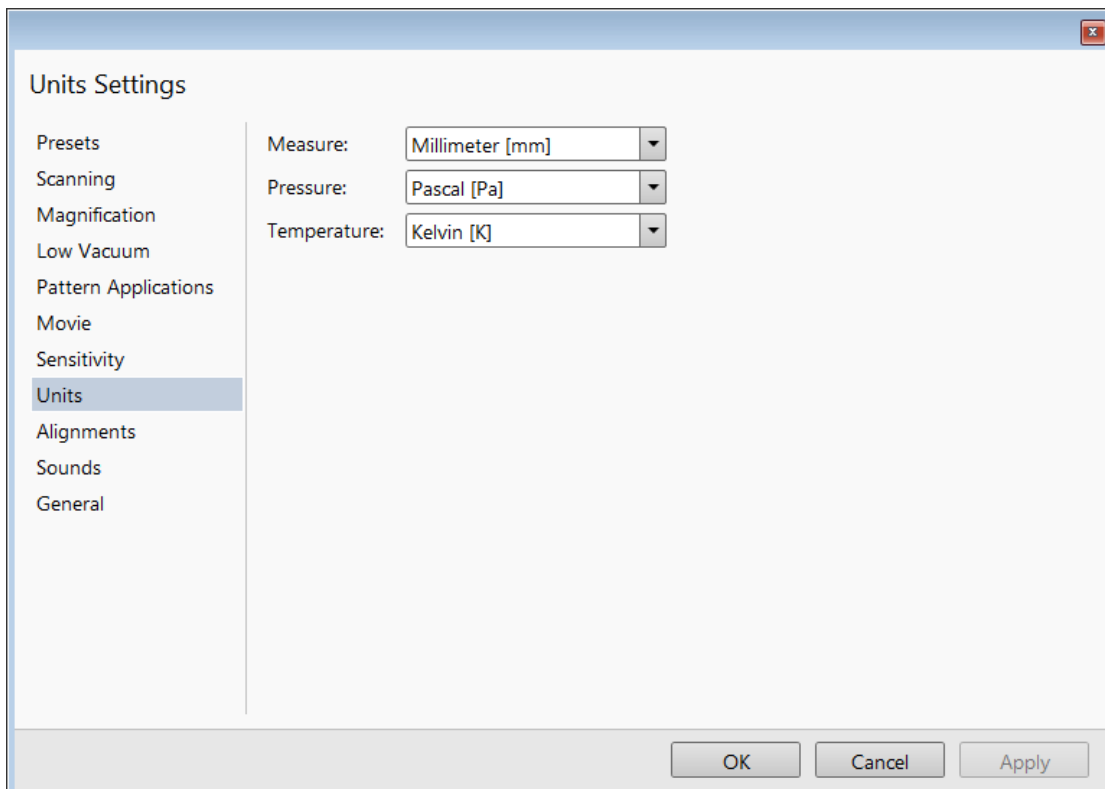
### Movie

For a detailed description see Chapter 5.

### Units

allow a user to change the Units of *Measure*, *Pressure* and *Temperature*. The choices affect the Stage module input boxes, the databar display, the status bar and so on.

**FIGURE 3-18:** *Units preferences*



Possible choices are:

- *Measure:* millimeter [mm] / micrometer [ $\mu\text{m}$ ]
- *Pressure:* Pascal [Pa] / torr [Torr] / millibar [mbar]
- *Temperature:* Kelvin [K] / Celsius [ $^{\circ}\text{C}$ ] / Fahrenheit [ $^{\circ}\text{F}$ ]

## Presets

Use this section to change the preset values within the *High Voltage*, *Magnification*, *Stage* and *Pressure* tabs.

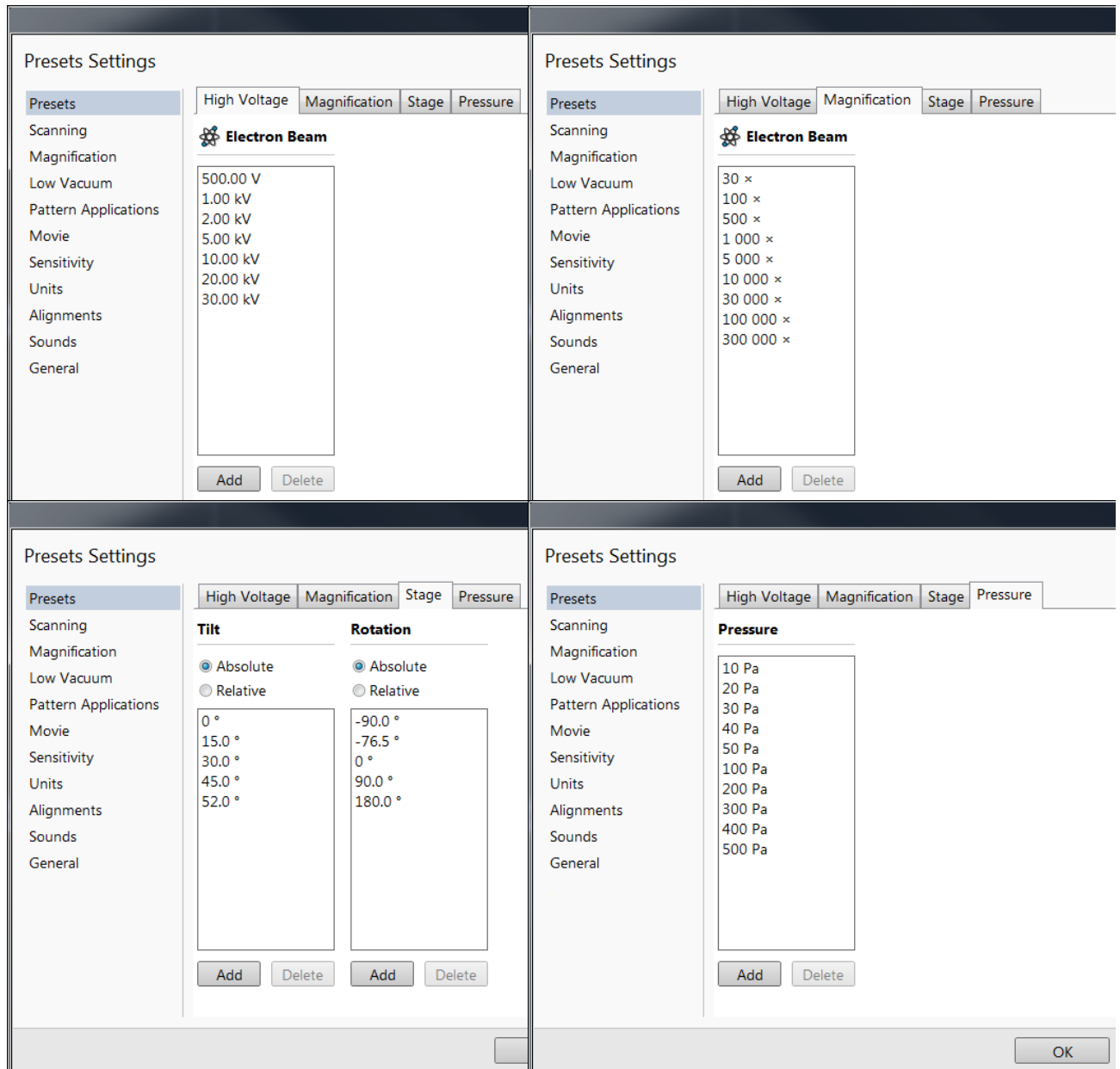
- *High Voltage* - values must be entered in kilovolts (0.2 kV = 200 V) and span from 350 V to 30 kV.
- *Magnification* - can be changed to hold frequently used magnifications from 20× to 1 000 000×. Values that are in the list but cannot be applied to the actual SEM conditions are not shown in the toolbar Magnification list box.

### Note

Alternatively, magnification could be shown as the Horizontal Field Width (see the Preferences... dialog / General section / Image dimensions control item).

- *Stage* - Tilt and Rotation presets can be set in Absolute or Relative values.
- *Pressure* - list can be changed to hold specific values frequently used in the Low Vacuum / ESEM mode within the range of 10 to 4 000 Pa.

**FIGURE 3-19** Presets preferences



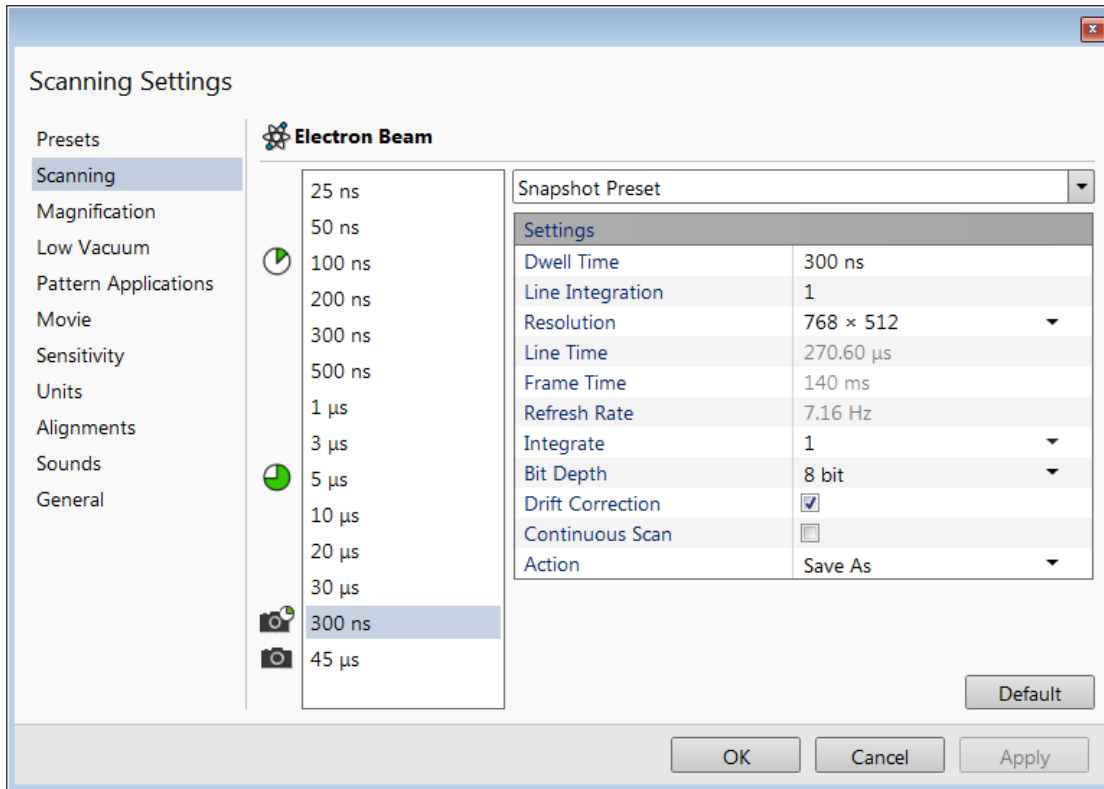
Click the *Add* button, add new value and confirm the entry; the new value is sorted into the list. Click the *Delete* button to delete selected value. The *Default* button on each tab sets the factory presets values.



## Scanning

allows a user to change the toolbar dwell-times (scanning speeds) table and to set-up the Slow scan / Fast scan / Snapshot / Photo function. The configuration and available items differ for the beam selected for the display.

**FIGURE 3-20:** Scanning preferences



On the left side of the module, there is a dwell-time preset list with the fixed number of entries. Selected *Preset* values can be changed in the Property editor on the right side of the module. The following properties are editable (depending on the type of preset):

- *Dwell Time* - the period of time during which the beam remains at the scanned point
- *Line Integrate* - number of line scanning repetitions
- *Resolution* - number of points, Width × Height (imaging resolution)
- *Integrate* - number of integrated frames in the range of 1 to 512
- *Bit Depth* - (8 bits / 16 bits) sets the captured image bit depth
- *Drift Correction* (Yes / No) - corrects imaging drifting when the integration filter is active. When activated, the text below the blinking pause icon within the display notifies a user.
- *Continuous Scan* (Yes / No) - when set to yes and the Snapshot / Photo function is started during scanning, the scanning finishes and the resulting image is acquired according to the preset.

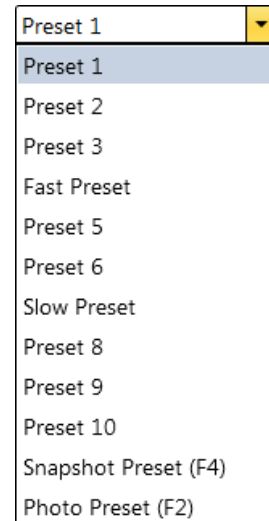
This functionality requires the same scanning conditions for the scan in progress and the Snapshot / Photo preset (Dwell time, Line integration, Resolution, Bit depth...). If they are not the same, an Application status warning message is shown. The functionality is convenient for charging samples.

- *Action* - activated at the end of Photo / Snapshot function:
  - Save - saves the image using an automatic file name and format
  - Save As - opens the Save As dialog to save the image
  - None - just pauses imaging

The following properties are informative and non-editable:

- *Line Time* - the line scan duration time
- *Frame Time* - the scan duration time
- *Refresh Rate* - imaging refresh frequency

Slow (large green sector) / Fast (small green sector) preset icons indicate the matching dwell-time values. To change it, move an icon up or down just by clicking on & dragging it.



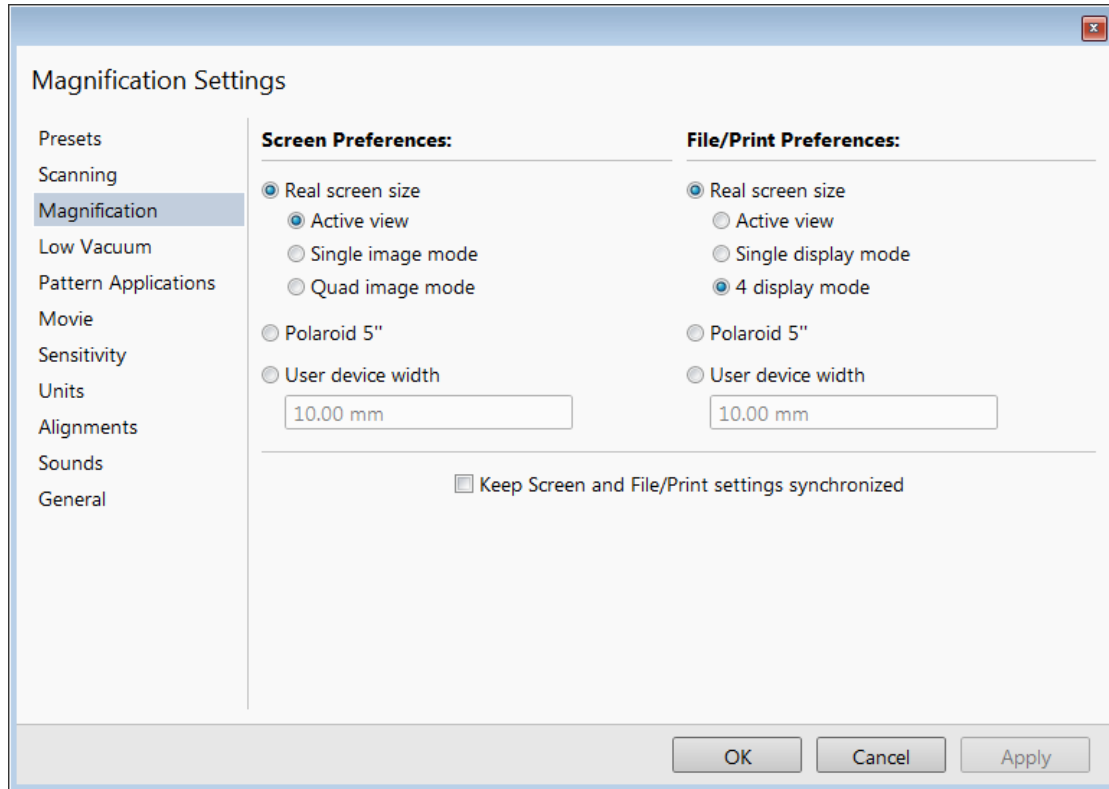
*Snapshot* (camera with small green sector) / *Photo* (camera) preset icon indicates the matching dwell-time value. Set all possible properties in the Property editor.

The *Default* button restores the default dwell-time list and preset settings.

## Magnification

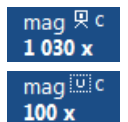
When storing / printing an image (while in Single image mode / Quad image mode / Large Image Window), the databar magnification representation might not be correct. This functionality is activated by checking the *Beam* menu / *Magnification Correction* item.

**FIGURE 3-21:** *Magnification preferences*



The *Screen preferences* area sets the image databar magnification representation behavior while the *File/Print preferences* area sets the storage / printing databar magnification representation behavior. Clicking the radio button activates the correction technique:

- *Real screen size*: the imaging pixel width is handled.
  - *Active view*: The databar magnification value depends on whether the Single or Quad Image mode is selected. It is shown in the image databar and stored / printed with an icon representing the Single / Quad Image mode.
  - *Single image / display mode*: Single image mode magnification value is shown in the databar and stored / printed with an image.
  - *Quad image / 4 display mode*: the Quad image mode magnification value is shown in the databar and stored / printed with an image.
- *Polaroid 5"*: Polaroid film width is handled. A recalculated magnification value is shown in the databar and stored / printed with an image.
- *User device width* (set by a user via the edit box): the recalculated magnification value is shown in the databar and stored / printed with an image.

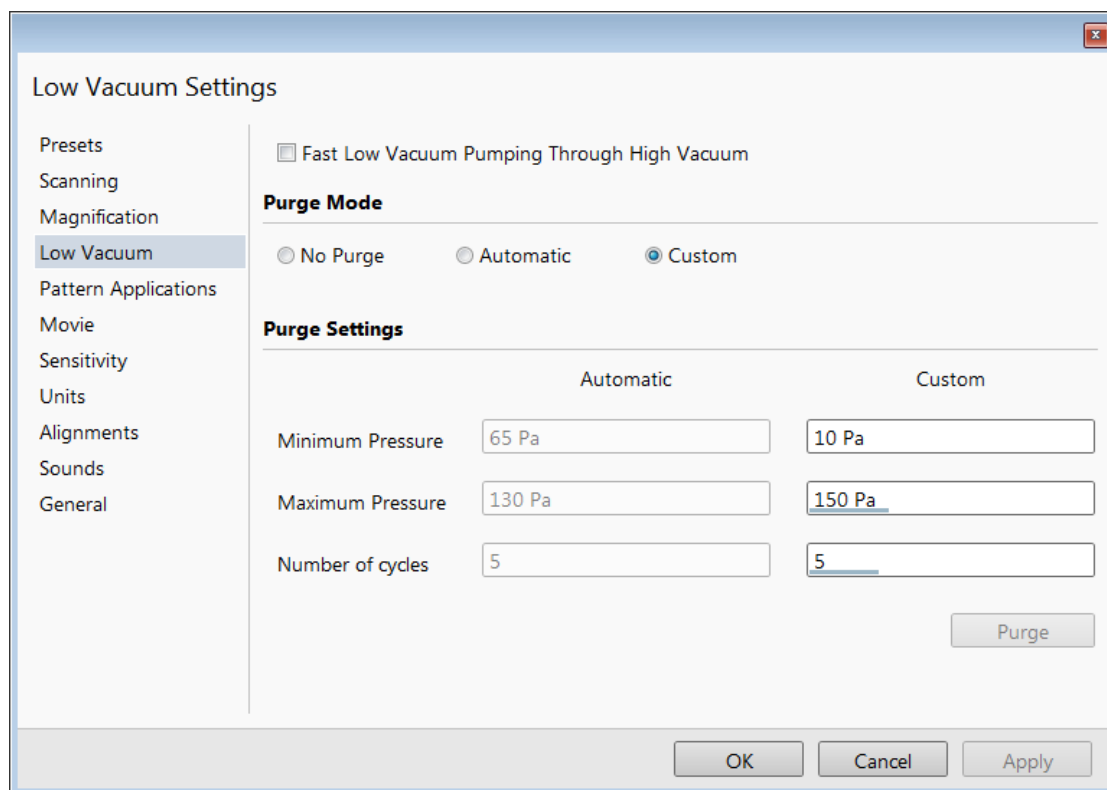


The *Keep Screen and File / Print settings synchronized* check box keeps both settings identical.

## Low Vacuum

The specimen chamber manual purging procedure (see Chapters 2) can be customized in this section.

**FIGURE 3-22:** *Low Vacuum preferences*



For highly outgassing samples the procedure can take very long time. In this case the *Fast Low Vacuum Pumping Through High Vacuum* check box must be cleared; the specimen chamber is then pumped to a pressure slightly lower than a desired LoVac pressure (see custom settings below) and proper purging ensures good water vapor or gaseous atmosphere in the chamber.

*Purge Mode* area contains following radio buttons:

- *No Purge* - the purging is switched off and the chamber pressure goes directly to the set Low Vacuum mode value. The gas mixture in the chamber slowly changes to the new gas type.
- *Automatic* - all purging parameters are set automatically, according to the mounted Low Vacuum detector (Cone).
- *Custom* - custom settings (see below) are used.

*Purge Settings* area contains following *Custom* settings and controls:

- *Minimum Pressure*
- *Maximum Pressure*
- *Number of cycles*  
Sets the above three parameters to the desired values for the procedure.
- The *Purge* button enables starting to purge manually (using the actual Purge Settings) when the system is already pumped to Low Vacuum; otherwise, the button is disabled. When purging is running, the Purge button becomes highlighted. Clicking on the highlighted button stops the purging procedure and returns the system to operation in Low Vacuum.

### Note

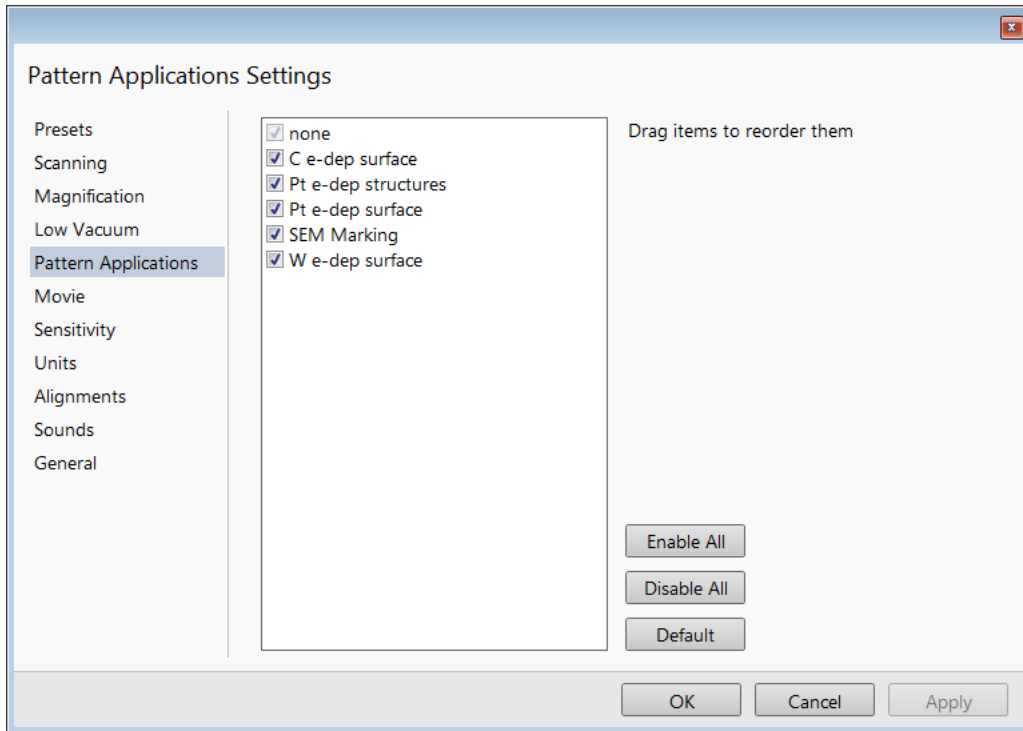
*During the purging procedure, the chamber pressure is not ready for SEM operation (the vacuum status is Pumping). Therefore, clicking the Purge button automatically switches off the accelerating voltage.*

*The Purge Settings are not remembered separately for each user. If the Purge settings are important, please check these Preferences before starting the Low Vacuum operation.*

## Pattern Applications

It is possible to enable / disable visibility of pattern applications in the *Patterning* page / *Property* module / *Application* item by checking the check box next to an application name.

**FIGURE 3-23:** *Pattern Applications preferences*

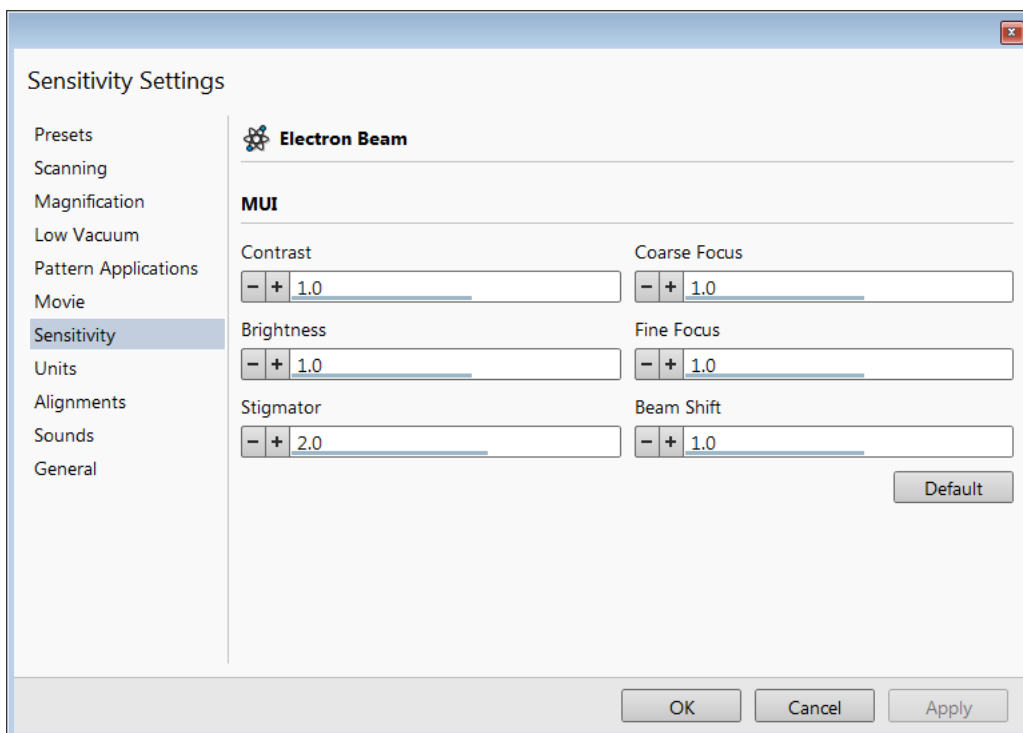


The *Default* button sets the original settings.

## Sensitivity

The preset sliders control the sensitivity of the Manual User Interface (*MUI* - option).

**FIGURE 3-24:** *Sensitivity preferences*

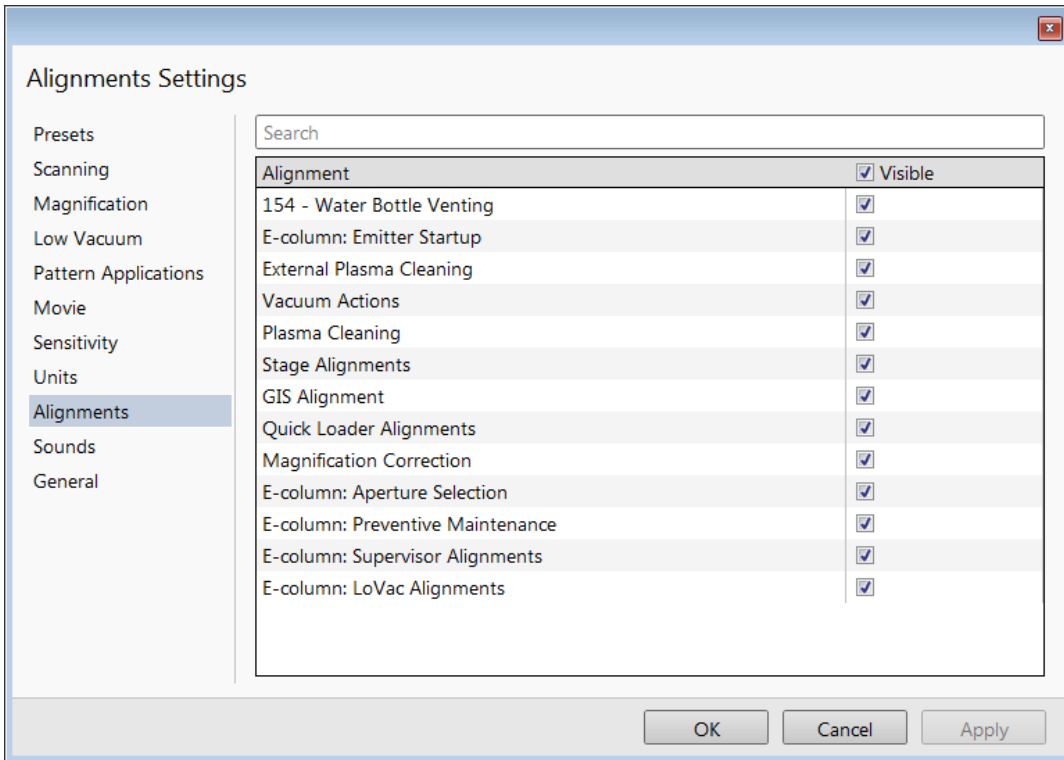


All MUI controls are represented except Magnification. The *Default* button sets the original settings.

### Alignments

It is possible to enable visibility of alignments in the *Alignments* page / *Alignments* list by checking the *Visible* check box next to an alignment name.

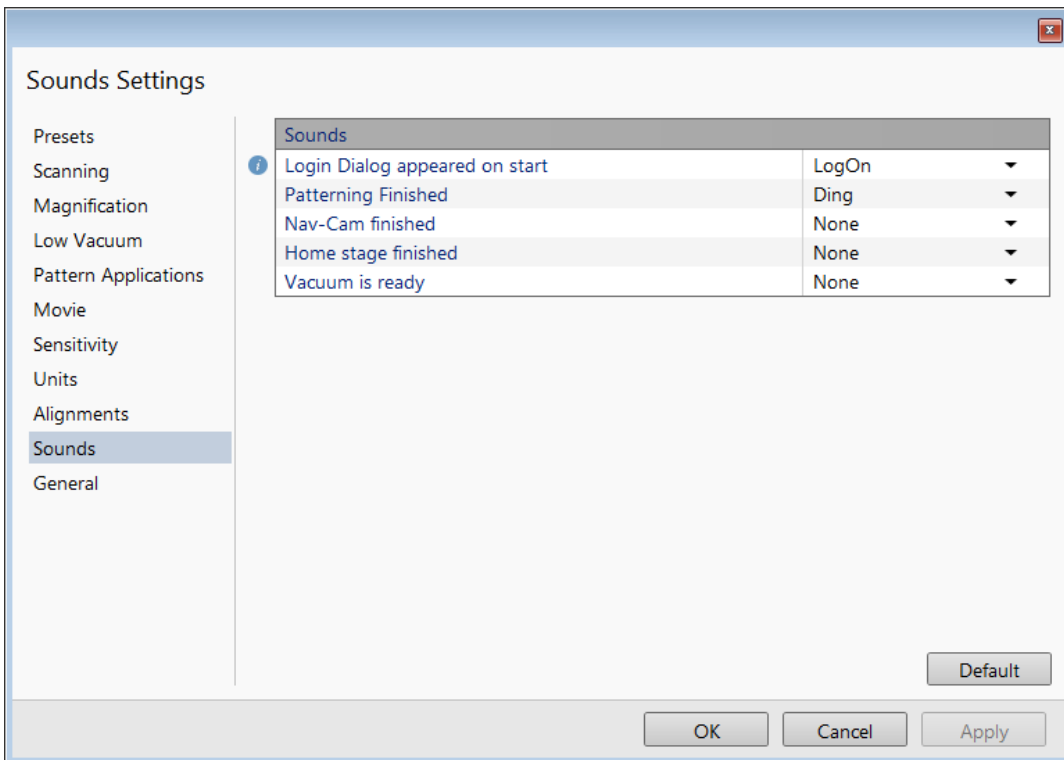
**FIGURE 3-25:** *Alignments preferences*



### Sounds section

Use the *Sounds* section to set system sound notices for selected tasks.

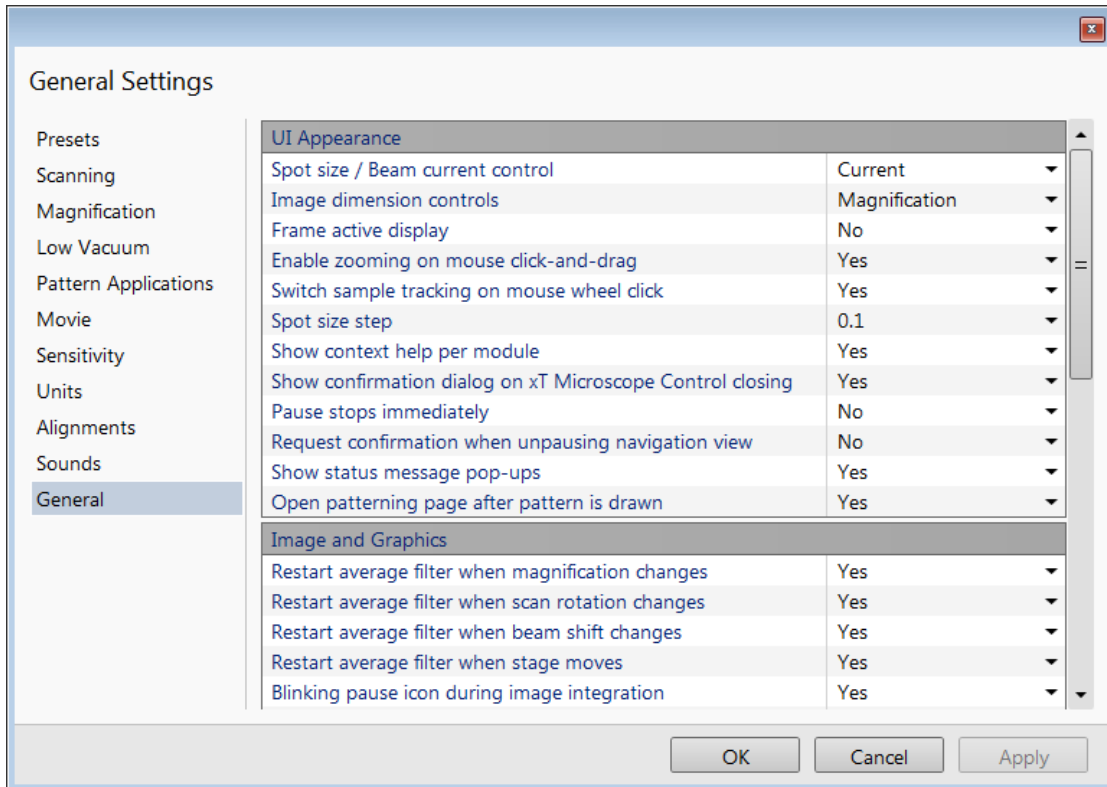
**FIGURE 3-26** *Sounds preferences*



## General

contains a variety of user settings for both the UI behavior and microscope operation, that do not logically belong to any other Preferences section.

**FIGURE 3-27:** *General preferences*



Each item in General Preferences is represented by a single line shown in the property editor. Clicking on the corresponding *Value* shows a drop-down list with the settings available for that item.

### Note

*Some of the items are model dependent, and some are intended for options.*

To make navigation among the number of preferences easier, they are divided into three groups.

**UI Appearance**

- *Spot size / Beam current control* (Spot / Current)  
Provides a choice of methods for showing values in the toolbar list box and Column module.
- *Image dimensions control* (Magnification / HFW)  
Selects the method of magnification representation and control.
- *Frame active display* (Yes / No)  
Switches on / off additional highlighting of the active display.
- *Enable zooming on mouse click-and-drag* (Yes / No)  
Set an option of mouse zooming.
- *Switch sample tracking on mouse wheel click on* (Yes / No)  
Switches the stage movement (tracking) control between the wheel-click and move and the wheel-click & drag modes.
- *Spot Size Step*: (0.1 / 0.01 / 0.001)  
Enables setting the accuracy of the spot size value.
- *Show context help per module* (Yes / No)  
Shows / hides the question mark button in the module header.
- *Show confirmation dialog on xT Microscope Control closing* (Yes / No)  
When Yes is selected, confirmation is needed to close the UI.
- *Pause stops immediately* (Yes / No)  
The Pause function acts instantly / waits for the complete scan.
- *Request confirmation when unpausing navigation view* (Yes / No)  
When releasing (unpausing) a window with a navigation image, confirmation can be switched on / off.
- *Show status message pop-ups* (Yes / No)  
Switches the status messages pop-up on / off.
- *Open Patterning page after pattern is drawn* (Yes / No)  
When a pattern shape was created with the use of a toolbar icon and Yes is set, the patterning page activates automatically.

UI Appearance
Spot size / Beam current control
Image dimension controls
Frame active display
Enable zooming on mouse click-and-drag
Switch sample tracking on mouse wheel click
Spot size step
Show context help per module
Show confirmation dialog on xT Microscope Control closing
Pause stops immediately
Request confirmation when unpausing navigation view
Show status message pop-ups
Open patterning page after pattern is drawn

**Image and Graphics**

- *Restart average filter when magnification changes* (\*)
- *Restart average filter when scan rotation changes* (\*)
- *Restart average filter when beam shift changes* (\*)
- *Restart average filter when stage moves* (\*)  
\* - (No / Yes)  
These items enable choosing whether imaging averaging should be restarted when the indicated parameter changes. Restarting the averaging filter causes the imaging to blink and get noisier; averaging slows down the imaging response to the changed parameter.
- *Blinking pause icon during image integration* (Yes / No)  
If Yes is selected, the blinking Pause symbol is shown in displays that are being stopped. Otherwise, the Pause symbol appears only after image acquisition has actually stopped.
- *Hide rotation controls when not used* (No / 10 seconds / 30 seconds / 60 seconds)  
Specifies if and when the on-image Scan / Compucentric Rotation control should be automatically switched off.
- *Show scan rotation in Camera displays* (Yes / No)  
This item specifies whether the Scan rotation indicator and value should be permanently shown in the optical display(s); only non-zero values are shown.
- *Show Stage Map in Navigation display* (Yes / No)  
shows saved positions in any navigation image, that is available (Nav-Cam, Navigation Montage, Navigation Alignment).
- *Save digitally zoomed image as* (Entire image / Zoomed area)  
When saving an image, this option enables saving only the zoomed area or the entire scanned area.
- *Show legacy scanning resolution* (Yes / No)  
enables showing of old format screen resolutions in the toolbar drop-down list, scanning presets and Photo / Snapshot presets.

Image and Graphics
Restart average filter when magnification changes
Restart average filter when scan rotation changes
Restart average filter when beam shift changes
Restart average filter when stage moves
Blinking pause icon during image integration
Hide rotation controls when not used
Show scan rotation in Camera displays
Show Stage Map in Navigation display
Save digitally zoomed image as
Show legacy scanning resolutions
Post Processing



- *Post Processing* (None / Standard / Custom #)  
Select an image post processing preset to be applied.

### Microscope Operation

- *Interactive Databar* (On / Off)  
Causes the image databar fields to be active (directly editable when possible) / inactive.
- *Scan rotation sensitivity* (0.1 / 0.01)  
Choose the Scan rotation setting sensitivity.
- *E-Beam Working Distance databar precision* (0.1 millimeters / 0.1 micrometers)  
It is possible to set the precision of the WD setting.
- *Lower stage when venting the chamber* (No / By 10 mm / Full down)  
Specifies whether the stage should automatically lower when venting the chamber. This is recommended, because it greatly diminishes the chance of hitting the final lens when closing the chamber doors after mounting a taller specimen.
- *Change magnification when pumping* (No / Set to 100× / Set to 200×)  
Specifies whether the magnification for electron imaging should be automatically set to a low value when the chamber is being pumped (presumably after replacing the specimen).
- *Switch off CCD automatically* (No / 1 minute / 10 minutes / 30 minutes / 1 hour / 2 hours / 6 hours)  
Specifies if and when the CCD camera and infrared LED's should be automatically switched off. The countdown starts when resuming optical imaging and continues regardless of operator activity.
- *Pause beam displays when switching off HV* (Yes / No)  
Specifies whether electron imaging should be automatically paused when switching the High Voltage off.
- *Allow Beam Shift in Get mode* (Yes / No)  
Enables / disables automatic using of Beam Shift when a user requires very small point-to-point movements (double-click on the sample point at high magnifications).
- *Blank E-beam during long stage moves* (Yes / No)  
Specifies whether the electron beam should be automatically blanked during long software controlled stage movements. This may protect extremely sensitive samples from exposure to the beam in undesired areas.
- *Delete image data when user logs off* (Yes / No)  
If Yes, any live and/or paused imaging in all displays is deleted when user logs off.
- *Unpause CCD camera for large Z movement* (Yes/No)  
Specifies if the optical camera should be automatically released during large Z-axis stage movements. This may prevent a collision between the stage and final lens pole.
- *Reverse joystick movement* (Yes / No)  
Normally the joystick movement direction corresponds to the stage movement, so the imaging moves in the opposite direction. This setting changes the direction of the stage response to joystick movement.
- *Auto switch stage measurement system* (Yes / No)  
Automatically switches the stage measurement systems off when not used to avoid light interference with 3rd party equipment (EDS detectors, etc.).
- *Retracted detector will be replaced with a standard detector* (Yes/No):  
If Yes, retracted detector will be replaced with system standard one, if No, imaging will be replaced with the system message "Detector retracted".
- *Chamber illumination* (Yes / No)  
If Yes and the in-chamber Nav-Cam is installed, inner chamber illumination is on when the chamber is vented.
- *Show sample exchange window on pump/vent* (Yes / No)  
When starting to pump or vent the chamber, the Sample exchange window opens automatically.
- *Venting valve opening time* (value)  
prolongs the venting time (default value is 180 s) to eliminate residual vacuum, which makes it impossible to open the chamber door, or shortens the venting time.
- *Default display for Nav-Cam image* (Display 1 / Display 2 / Display 3 / Display 4 / Active)  
This option sets the default Nav-Cam imaging display, which is automatically activated when taking the Nav-Cam photo.

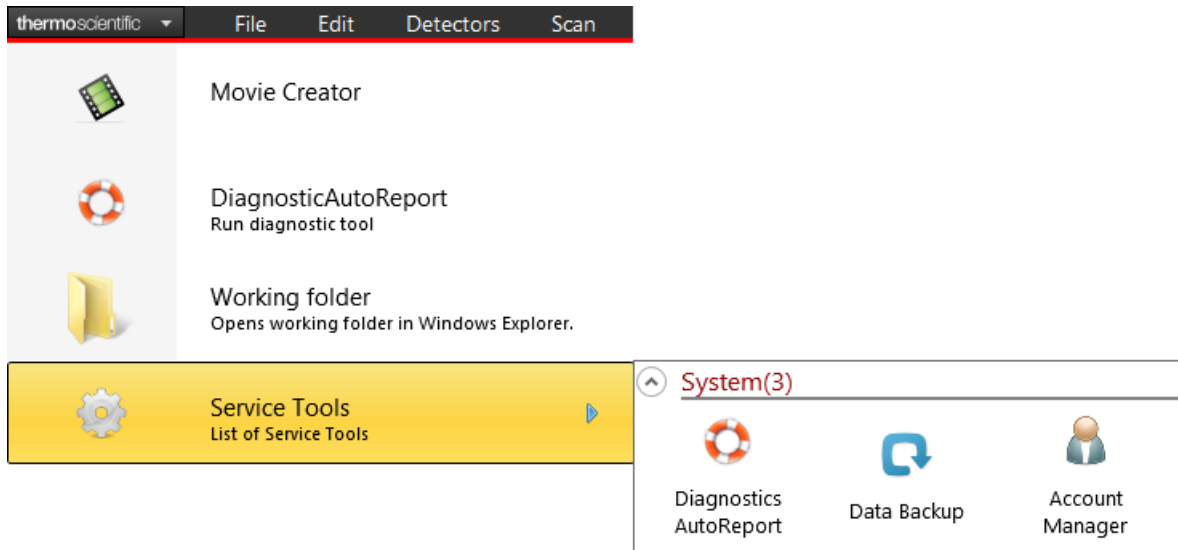
Microscope Operation
Interactive Databar
Scan rotation sensitivity
E-Beam Working Distance databar precision
Lower stage when venting the chamber
Change magnification when pumping
Switch off CCD automatically
Pause beam displays when switching off HV
Allow beam shift in Get Mode
Blank E-beam during long stage moves
Delete image data when user logs off
Unpause CCD camera for large Z movement
Reverse joystick movement
Auto switch stage measurement system
Retracted detector will be replaced with a standard detector
Chamber illumination
Show sample exchange window on vent
Venting valve opening time
Default display for Nav-Cam image

## Account Manager application

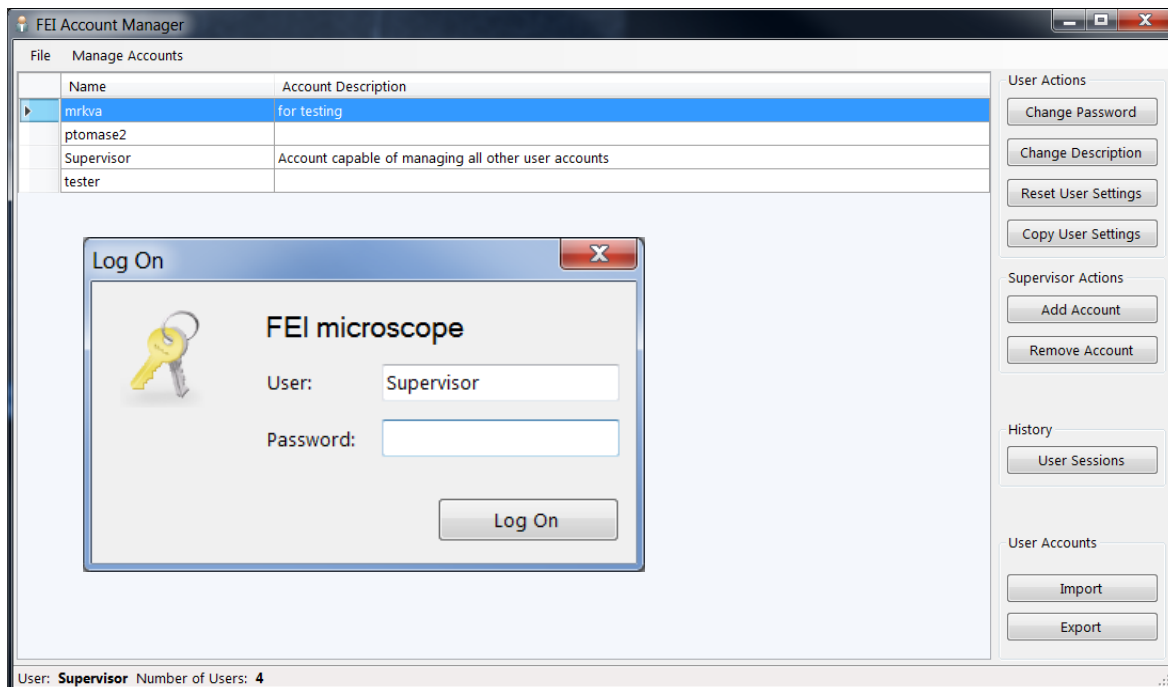
The *Account Manager* application allows to a Supervisor (accounts manager) to organize user accounts. It allows the creation and removal of user accounts, settings, passwords, as well as their descriptions. User accounts ensure for all users admission to both the operating system Windows 7 and the xT microscope Server / Microscope Control software.

### Accounts control

You can start the software by clicking the *Thermo Scientific* menu / *Service Tools* / *Account Manager* icon:

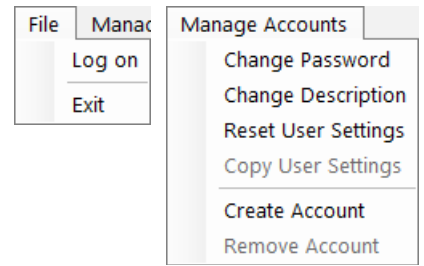


This brings up the *Log On* dialog box, containing *User* and *Password* text fields, for entering the account manager. For the first time log on with the Supervisor / Supervisor credentials; the application window appears.



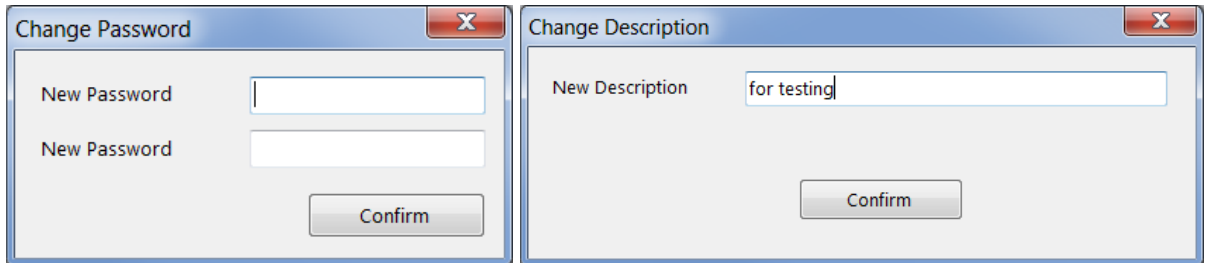
The *Supervisor* (default) account can not be deleted and only the Supervisor can manage it; it has the right to create and delete user's accounts and to change all their settings. Particular users has a limited right to manage only its own account.

The *File* and *Manage Accounts* menus contains the same controls (with a few exceptions), as the buttons placed at the right side of the window. Some actions are intended for supervisor only.

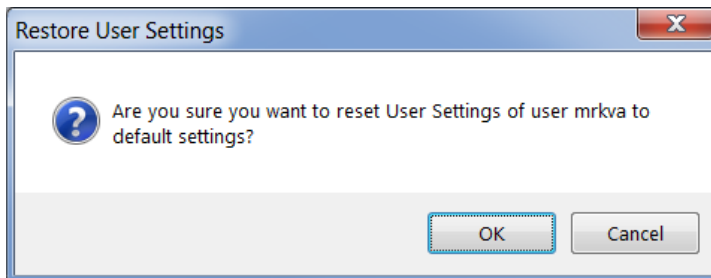


Clicking the button / menu item starts the action for a selected (highlighted) account.

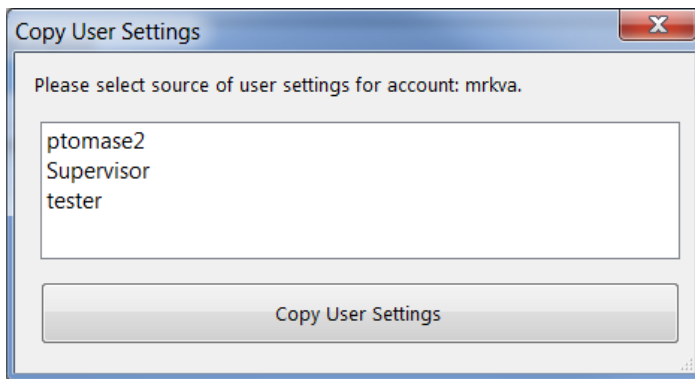
- *Log on* - logs on a new user (an actual user is logged out)
- *Exit* - exits the application
- *Change Password / Description* - sets a new password / account description.



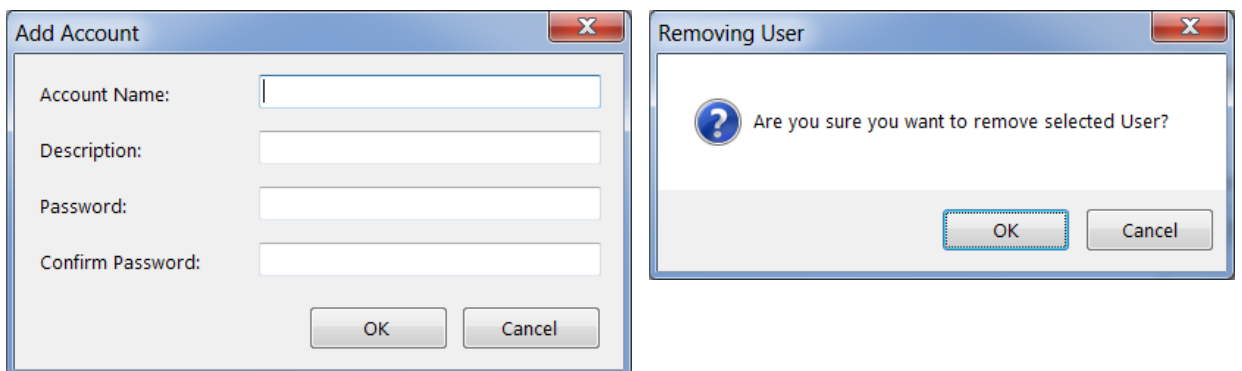
- *Reset User Settings* - restores user account setting to the factory default.



- *Copy User Settings* - select a user account from which settings are copied.

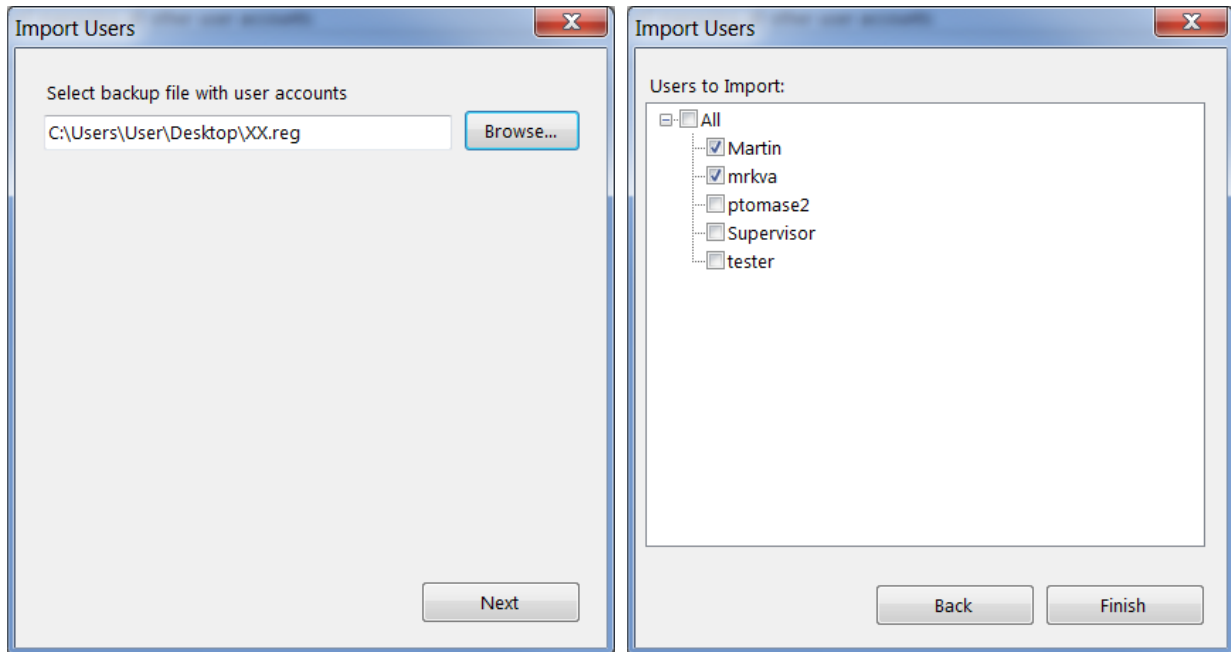


- *Add (Create) (Supervisor) / Remove Account (Supervisor)* - enter information to create a new user account. To remove user account the confirmation is needed.



- *User Sessions (Supervisor)* - shows the login (.CSV) file for all user accounts.

- *Import (Supervisor) / Export* - imports selected user(s) from a previously exported (.REG) file.



## User Logins and Account Settings

Each user login account stores a variety of configuration data in the registry. These values are then restored when that user logs back into the system.

### Overall layout and settings for the UI

Overall stored settings:

- Electron beam settings (HV, current, HFW)
- Dwell, resolution, position for each beam in full frame, reduced area, line, and spot modes
- Detector settings (bias voltages, etc.)
- Preferences
- Workspace (toolbar, side pan - pages, keyboard - short cuts)

Stored settings for each display:

- Active beam (electron, optical)
- Image save file path
- Image save settings (databar or overlays included)

Stored settings for each beam in each display:

- Active detector
- Detector subsettings for all detectors (is CDEM in SE or SI mode)
- Detector mixing settings
- Digital brightness/contrast/gamma settings
- Databar text
- Zoom and pan (shift) values for digital zoom mode

Others

- Various patterning settings

# Entering commands

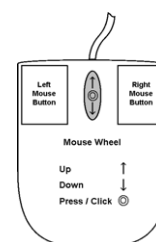
## Using mouse

**Table 3-2** Mouse keys shortcuts

Keyboard + Mouse button	Function
<b>(Shift +) Click on</b> <i>arrow cursor</i>	selects / activates (a) control element(s) (toolbar pause icon: pauses / releases all displays Photo icon / Snapshot icon / Scanning preset button: activates appropriate enhanced / alternative functionality)
<b>(Ctrl +) Click on</b> <i>arrow cursor</i>	selects a graphical item within an imaging area (adds another one to the selection)
<b>Click on &amp; drag (+ Shift)</b> <i>arrow cursor</i> (with + / - magnifying glass icon)	selects a display area to zoom in (dragging the mouse down-right) / out (dragging the mouse down-left, up-left, up-right)
<b>Ctrl + click on &amp; drag</b>	controls the detector contrast / brightness by dragging the mouse left-right / up-down
<b>Shift + click on &amp; drag</b> <i>hand-cursor</i>	activates the Beam Shift
<b>Double-click on</b>	<i>Electron Imaging:</i> Get mode: moves a point to the display center <i>Optical Imaging:</i> places 10 mm marker
<b>Right-click on &amp; drag</b> <i>2-ended arrow cursor</i>	focuses by dragging the mouse left-right
<b>Ctrl + right-click on &amp; drag</b> <i>4-ended arrow cursor with circles</i>	activates Lens Alignment
<b>Shift + right-click on &amp; drag</b> <i>4-ended arrow cursor</i>	corrects and imaging astigmatism by dragging the mouse left-right - X stigmator or up-down - Y stigmator
<b>Ctrl + wheel-roll up / down</b>	coarsely increases / decreases magnification
<b>Shift + wheel-roll up / down</b>	finely increases / decreases magnification
<b>Ctrl + Shift + wheel-roll up / down</b>	increases / decreases digital zoom magnification
<b>(Ctrl+) Wheel-click on &amp; drag</b>	<i>Electron Imaging:</i> Track mode: moves the stage (joystick-like control) <i>Optical imaging:</i> moves the stage in Z-axis direction (tilts the stage) by dragging the mouse up / down (left / right)

**Note**

The given sequence for the key press and mouse button clicks are important for some functions.



## Using keyboard

---

**Table 3-3** *Windows system shortcuts*

<b>Key (+ Key)</b>	<b>Function</b>
<b>Enter</b>	equivalent to the OK button in dialogs
<b>Esc</b>	equivalent to the Cancel button
<b>Tab</b>	switches between entry fields within dialog boxes
<b>Arrows</b>	selects an item within list boxes
<b>Alt (F10)</b>	accelerator keys (underlined menu bar item characters) - by hitting it, a corresponding menu list is expanded directly; another accelerator key can subsequently be selected
<b>Alt + Tab</b>	switches between running applications: each time the Tab key is hit while holding the Alt key a pointer jumps to another application icon. Releasing the Alt key at any time makes the application just listed become focused
<b>Alt + F4</b>	closes focused the application or the Windows operating system
<b>Del(ete)</b>	deletes a selection, texts or graphics
<b>Ctrl + A</b>	selects all items, texts or graphics within a focused window
<b>Ctrl + C</b>	copies a selection to the clipboard - temporary memory
<b>Ctrl + V</b>	pastes the contents of the clipboard text: at the pointer position graphics: to a active window
<b>Ctrl + X</b>	cuts a selection to the clipboard - copies and deletes it

**Table 3-4** Function and specific key shortcuts

<b>Key (+ Key)</b>	<b>Function</b>
<b>Esc</b>	1. stops the stage motion at that point <i>Note:</i> during particular procedures, the Home Stage for instance, use the software Cancel or Stop button! 2. cancels the drawing mode in Patterning, Measurement & Annotation or Text cursor
<b>F1</b>	shows documentation
<b>Shift + F1</b>	shows Image properties
<b>(Shift +) F2</b>	Starts Photo with a selected beam (at once, in all displays with the same beam)
<b>Ctrl + (Shift +) F2</b>	starts / stops Active Preset Snapshot (from all displays at once)
<b>(Ctrl+) F3</b>	toggles Videoscope On / Off (in all displays)
<b>Shift + F3</b>	starts the Home Stage procedure
<b>F4</b>	Starts / Stops electron imaging Snapshot from the active display
<b>Shift + F4</b>	starts / stops the Lens Alignment procedure
<b>F5</b>	toggles Single / Quad Image mode
<b>Ctrl + F5</b>	toggles Large Image Window mode On / Off
<b>Shift + F5</b>	toggles Center Cross On / Off
<b>F6</b>	pauses / releases scanning
<b>Shift + F6</b>	toggles Alignment rectangle On / Off
<b>F7</b>	toggles Reduced Area On / Off
<b>Ctrl + F7</b>	starts the Image Post Processing procedure
<b>F8</b>	starts the Degauss procedure
<b>(Shift +) F9</b>	starts the Auto Contrast Brightness procedure (in all live displays)
<b>F11</b>	starts the Auto Focus procedure
<b>Ctrl + F11</b>	starts the Auto Stigmator procedure
<b>Shift + F11</b>	toggles Display Saturation tool On / Off
<b>(Shift +) F12</b>	toggles Compucentric (Scan) Rotation tool On / Off
<b>Ctrl + 0 - number</b>	Center Position procedure - moves stage to X=0, Y=0 -
<b>Ctrl + B</b>	toggles Beam Blank function On / Off
<b>Ctrl + E</b>	tilts stage to 0°
<b>Ctrl + F</b>	sets Electron beam focus to eucentric WD (10 mm)
<b>Ctrl + H</b>	sets Horizontal Field Width (HFW)
<b>Ctrl + K</b>	sets Spot mode conditions
<b>Ctrl + M</b>	sets Full Frame scanning conditions
<b>Ctrl + Shift + M</b>	starts movie recording
<b>Ctrl + N</b>	toggles Sample Navigation On / Off
<b>(Ctrl +) Shift + N</b>	starts to mill (previous) next pattern line
<b>Ctrl + O - letter</b>	opens Preferences dialog



**Table 3-4** *Function and specific key shortcuts*

<b>Key (+ Key)</b>	<b>Function</b>
<b>Ctrl + P</b>	opens Print dialog
<b>Shift + P</b>	proceeds with next pattern
<b>Ctrl + R</b>	restarts scan
<b>Ctrl + (Shift +) S</b>	saves image(s) (from all displays)
<b>Ctrl + Y</b>	redoes the last operation
<b>Ctrl + Z</b>	undoes the last operation
<b>Ctrl + Shift + Z</b>	starts the Take Nav-Cam Photo procedure
<b>(Ctrl +) Pause</b> - keyboard key	starts / stops (/ resets) patterning
<b>Ctrl + (Shift +),</b>	sets one step slower (slowest) scanning
<b>Ctrl + (Shift +) .</b>	sets one step faster (fastest) scanning
<b>Ctrl + (Shift +) Tab</b>	activates displays stepwise (backward)
<b>Ctrl + Page Up / Down</b>	switches within Control pages stepwise
<b>Ctrl + 1 / 2 / 3 ...</b> - letter keypad	selects the particular page - the number corresponds to the page icon sequence
<b>(Ctrl +) + / - - keypad</b>	increases / decreases the magnification 2× (Digital Zoom)
<b>* - keypad</b>	rounds off the magnification / HFW to a nearest round value
<b>Ctrl (+ Alt) + arrow</b>	moves the digital zoom area (the pattern) by one screen pixel in the corresponding direction
<b>(Shift +) Arrows</b>	moves the stage approximately by (40%) 80% of the field of view in the corresponding direction

On the *Microscope Alignments* page select an alignment procedure available from the list box. Always follow the instructions given in the *Instructions* module. The *Step* shows the present control step number and the total number of steps. You can find some additional explanations in this chapter.

## Common Rules

Alignments should be performed in the display 1. Using different display does not ensure the correct functionality of the Contrast, Brightness and Auto functions within the Microscope Alignments page.

Before aligning the Electron column, be sure that the final lens aperture is clean.

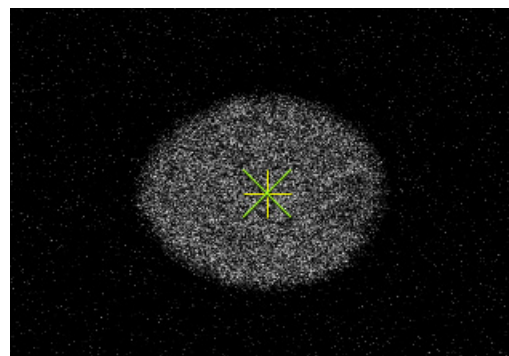
During adjustment procedures, changing the magnification and the scanning speed are allowed, as is using a reduced area and optimizing image contrast / brightness. It is also possible to correct astigmatism and to focus an image (for a particular alignment this is forbidden).

During adjustment procedures changing the Vacuum Mode, the Spot size and High Voltage are not allowed. Do not use the Beam Shift at any time during the adjustment procedures, as this is set to the zero value at each alignment section. All specimen movements can be made using the stage where appropriate.

## Buttons and Control Elements

The following buttons and control elements have the same behavior for all alignment procedures, when available:

- *Start* button - starts the procedure and proceeds with subsequent dialogs.
- *End* button - moves a user to the last step (after clicking on the *Next* button) to enable finishing the alignment procedure.
- *Finish* button - saves new settings, ends the procedure and closes the dialog.
- *Save* button - saves new settings at that point without closing the dialog.
- *OK* button - applies all changes made in the dialog and closes it.
- *Apply* button - saves and applies new settings at that point without closing the dialog.
- *Cancel* button - discards all changes made from the last save and closes the dialog. It has the same effect as closing the dialog with the cross (Alt + F4).
- *Next* button - moves a user to the following dialog after necessary settings have been done.
- *Previous* button - moves a user to the previous dialog when settings need to be changed.
- *Contrast / Brightness* adjusters - enable optimizing the image quality during alignment.
- *Auto* button - executes the appropriate alignment action automatically for a particular voltage / spot / direction (whatever suitable) with the use of the *Image Recognition* software. If this utility does not recognize image features well, the procedure is aborted and a Warning message appears onscreen. In this case, change the imaging conditions (better focus, slower scanning, or lower magnification) and try again.
- *Crossover* button - activates the Crossover mode, where the onscreen image shows an aperture projection instead of a sample.
- *Modulator* button - starts automatic parameter oscillation to facilitate the process.



## Alignments List

Grouped alignments lists are possible to roll down / up by clicking the + / - sign. The alignments accessible for a Supervisor are presented. The user-accessible alignments (a reduced list) are marked by the (U) sign in the following list:

### Electron Beam

- *E-column: Emitter Startup*  
Enables IGP's and electron source - emitter switching On / Off.
- *Magnification Correction*  
User magnification calibration (see Beam menu item).
- *E-Column: Aperture Selection*  
Enables setting a second set of final lens apertures in case the image quality deteriorates (one or more actually used apertures are worn out).
- *E-Column: Preventive Maintenance*  
- *Source Tilt* - electron beam adjustment procedure.
- *E-Column: Supervisor Alignments*  
- *Sample Alignment* -  
- *Aperture Alignment* -  
- *Source DPA and Tilt and Shift* -  
Set of Supervisor level electron beam adjustment procedures.
- *E-Column: LoVac Alignments*

### Stages

- *Stage Alignments* - set of utilities:  
- *Stage Rotation Center* - sets the stage rotation center for the compucentric rotation.

### Others

- *154 - Water Bottle Venting*  
Enables venting the water bottle to allow refilling it.
- *External Plasma Cleaning / Plasma Cleaning*  
Enables chamber plasma cleaning and sets the duration of the specimen plasma cleaning.
- *Vacuum Actions* - set of utilities:  
- *Start / Stop IGPs* - enables starting / stopping vacuum pumps in case of power failure, emergency or service actions  
- *Pump / Vent Actions* - enables pumping / venting particular vacuum system sections  
- *Pump Buffer* - enables immediately pumping down the vacuum buffer
- *GIS Alignment* (option)  
Resets the GIS crucible filling lifetime counter after its exchange, sets the GIS heating temperature, and performs GIS mechanical alignment.
- *Quick Loader Alignments* (option - see Chapter 7)

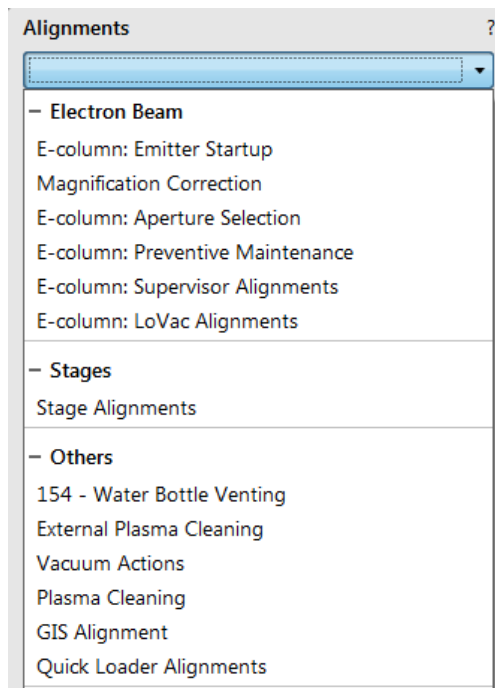
## Recommendation

Some procedures may influence others. Therefore care should be taken to monitor the influence of any actions taken. Alignment procedures should be carried out whenever necessary during normal operation:

- *Stage Alignments / Stage Rotation Center*
- *E-Column: Preventive Maintenance / Source Tilt*

### Model difference

Apereo High Vacuum has a slightly modified alignments list.



## Automatic Alignments

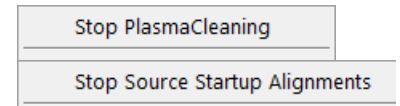
Some Alignments (or sets of alignments) have a different approach, and most of the procedures can run automatically by checking the *Automatic* check box at the bottom of the alignment module. Automatic progress can be started / stopped at any time during the procedure. Accessible informational windows can be turned on / off by the *Show / Hide Window* button. The alignment sequence can be cancelled / continued by the *Cancel / Next* button.



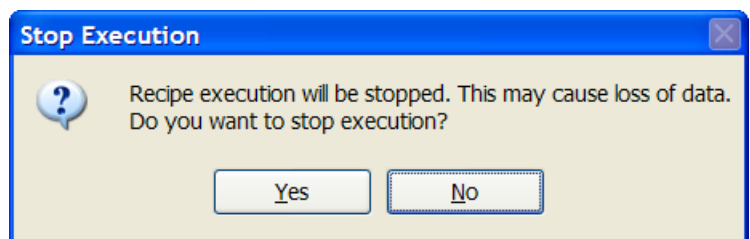
### Caution!

*Read carefully the instructions provided by the system before proceeding with any alignment!*

If you have any e-beam alignment procedure selected and you want to select another one, you must *Finish* or *Cancel* any actually opened procedure first. To start the alignment procedure or to stop one in progress, right-click on the red circle and select the required action (*Start / Stop - variable*) from the context menu. A confirmation dialog is shown.

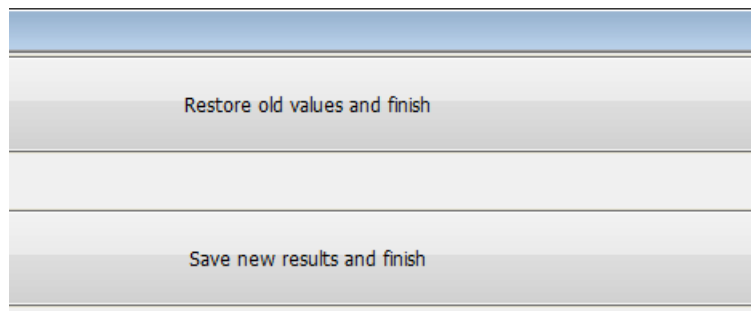


When interrupting any alignment (clicking on the *Cancel* button, selecting the *Stop* item in the menu, closing the UI), nothing is saved. In all cases, the alignment windows disappears and the *Stop Execution* dialog appears.



The last page of every alignment offers one or more of the following choices:

- *Restore old values and finish*: undoes the adjustments; nothing will be saved.
- *Save new results and finish*: keeps the new adjustment values and saves them.



## Results

The result of every step is shown by means of an icon in the result list when performing alignment steps.

**FIGURE 4-1:** *Alignments Results*

	Description	Result	Time
<input type="checkbox"/> ◊	37 DPA: UseCase: Analytical, CMI: 7, HV: 20000 V, Spot: 19		
<input type="checkbox"/> ◊	38 DPA: UseCase: Analytical, CMI: 7, HV: 10000 V, Spot: 19		
<input type="checkbox"/> ◊	39 DPA: UseCase: Analytical, CMI: 7, HV: 5000 V, Spot: 19		
<input checked="" type="checkbox"/> ✓	40 Tilt & Shift: UseCase: OptiPlan, CMI: 1, HV: 500 V, Spot: 7	Tilt & Shift: Reliable	10:51 AM
<input checked="" type="checkbox"/> ✓	41 Tilt & Shift: UseCase: OptiPlan, CMI: 1, HV: 500 V, Spot: 15	Tilt & Shift: Reliable	10:51 AM
<input checked="" type="checkbox"/> ✓	42 Tilt & Shift: UseCase: OptiPlan, CMI: 1, HV: 593 V, Spot: 7	Tilt & Shift: Reliable	10:52 AM
<input checked="" type="checkbox"/> ✓	43 Tilt & Shift: UseCase: OptiPlan, CMI: 1, HV: 593 V, Spot: 15	Tilt & Shift: Reliable	10:53 AM
<input checked="" type="checkbox"/> ✓	44 Tilt & Shift: UseCase: OptiPlan, CMI: 1, HV: 800 V, Spot: 7	Tilt & Shift: Reliable	10:54 AM
<input checked="" type="checkbox"/> ✓	45 Tilt & Shift: UseCase: OptiPlan, CMI: 1, HV: 800 V, Spot: 15	Tilt & Shift: Reliable	10:55 AM
<input checked="" type="checkbox"/> ◊	46 Tilt & Shift: UseCase: OptiPlan, CMI: 1, HV: 1000 V, Spot: 7	Tilt: Reliable, Shift: No detail in image	10:56 AM
<input checked="" type="checkbox"/> ▶	47 Tilt & Shift: UseCase: OptiPlan, CMI: 1, HV: 1000 V, Spot: 15	Tilt: Reliable	10:56 AM
<input checked="" type="checkbox"/> ◊	48 Tilt & Shift: UseCase: OptiPlan, CMI: 2, HV: 1051 V, Spot: 7		
<input checked="" type="checkbox"/> ◊	49 Tilt & Shift: UseCase: OptiPlan, CMI: 2, HV: 1051 V, Spot: 15		
<input checked="" type="checkbox"/> ◊	50 Tilt & Shift: UseCase: OptiPlan, CMI: 2, HV: 1500 V, Spot: 7		
<input checked="" type="checkbox"/> ◊	51 Tilt & Shift: UseCase: OptiPlan, CMI: 2, HV: 1500 V, Spot: 15		
<input checked="" type="checkbox"/> ◊	52 Tilt & Shift: UseCase: OptiPlan, CMI: 2, HV: 2000 V, Spot: 7		
<input checked="" type="checkbox"/> ◊	53 Tilt & Shift: UseCase: OptiPlan, CMI: 2, HV: 2000 V, Spot: 15		
<input checked="" type="checkbox"/> ◊	54 Tilt & Shift: UseCase: OptiPlan, CMI: 2, HV: 3000 V, Spot: 7		
<input checked="" type="checkbox"/> ◊	55 Tilt & Shift: UseCase: OptiPlan, CMI: 2, HV: 3000 V, Spot: 15		
<input checked="" type="checkbox"/> ◊	56 Tilt & Shift: UseCase: OptiPlan, CMI: 2, HV: 5000 V, Spot: 7		
<input checked="" type="checkbox"/> ◊	57 Tilt & Shift: UseCase: OptiPlan, CMI: 2, HV: 5000 V, Spot: 15		
<input checked="" type="checkbox"/> ◊	58 Tilt & Shift: UseCase: OptiPlan, CMI: 2, HV: 10000 V, Spot: 7		

Show previous results  
 Select only alignments and steps with non-reliable results

- Unavailable:** ◊  
 The result has never been obtained, at least not by this procedure. This may mean that it has never run, or that it failed to do anything meaningful (the difference between these two is not important).
- Reliable:** ✓  
 The result is trusted by the automatic procedure, or a user has passed the alignment step manually.
- Unreliable:** ?  
 The automatic procedure has done meaningful work, but cannot decide whether the obtained result can be trusted. This suggests reviewing the result manually.
- Out of range:** ⚡  
 The automatic procedure trusts that the optimal outcome is outside the range of the variable to be aligned. A value is set that is near the border of the range.

## E-column: Emitter Startup

---

This procedure enables electron source switching On / Off. In cases of emergency shut down, it allows starting the IGP's (Ion Getter Pump) to pump the electron source space.

The screenshot shows a software dialog box titled "Alignments" with a question mark icon in the top right corner. A dropdown menu at the top is set to "E-column: Emitter Startup". Below this, a blue header bar also displays "E-column: Emitter Startup".

**Emitter Startup**

This procedure starts or stops the emitter.

- Click the 'Start Emission' button to start the emission.
- Click the 'Stop Emission' button to stop the emission.

If none of the buttons is available, check the pressure in the column.

Current FEG state: Operate

Start Emission      Stop Emission

Remaining Time: 0

Suppressor: 500 V

Extractor: 3500 V

Filament: 1.500 A

Emission: 36.9  $\mu$ A

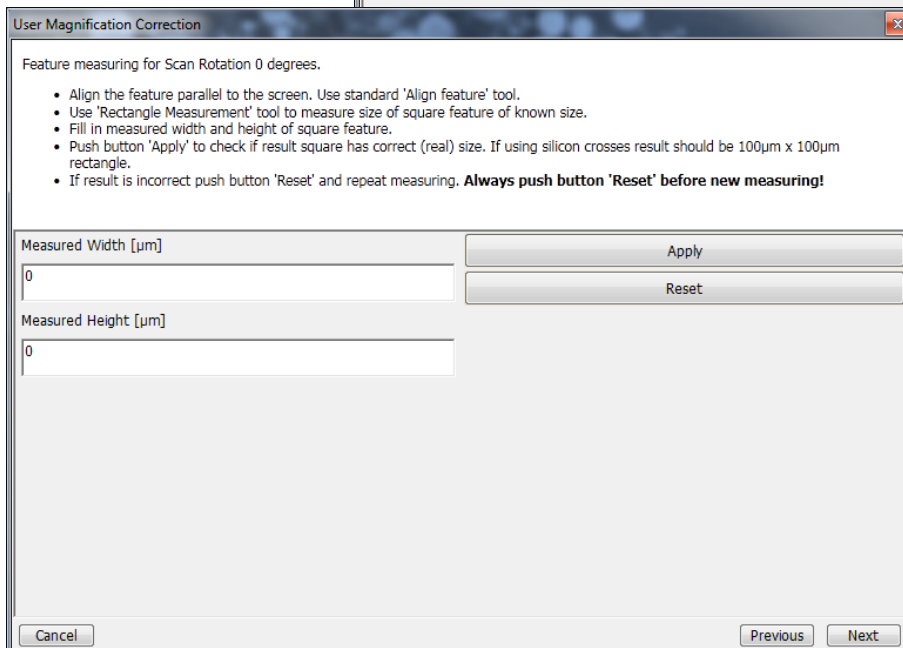
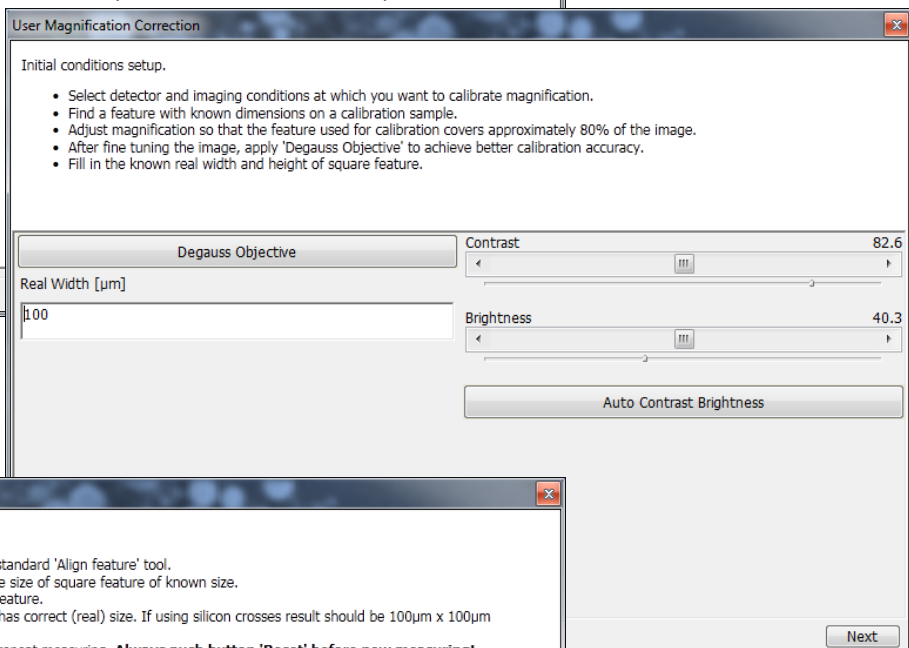
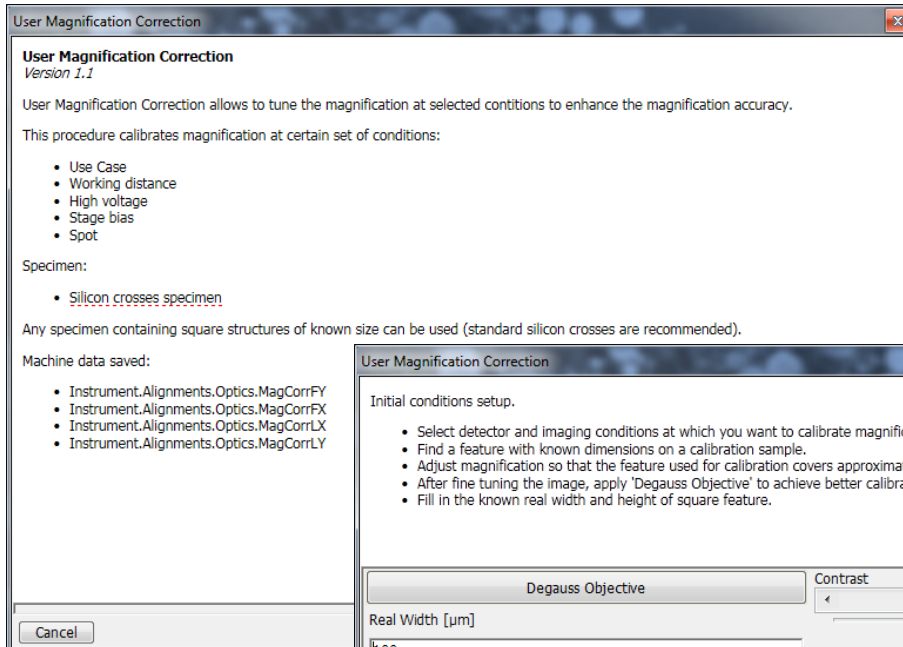
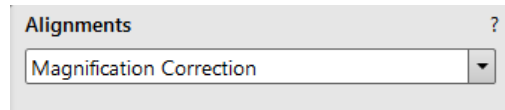
Emitter Age: 1 h 19 min

Cancel      Finish

At the bottom left of the dialog, there is a red circle icon.

# Magnification Correction

This utility is intended to enhance factory calibration accuracy under particular user selectable conditions.



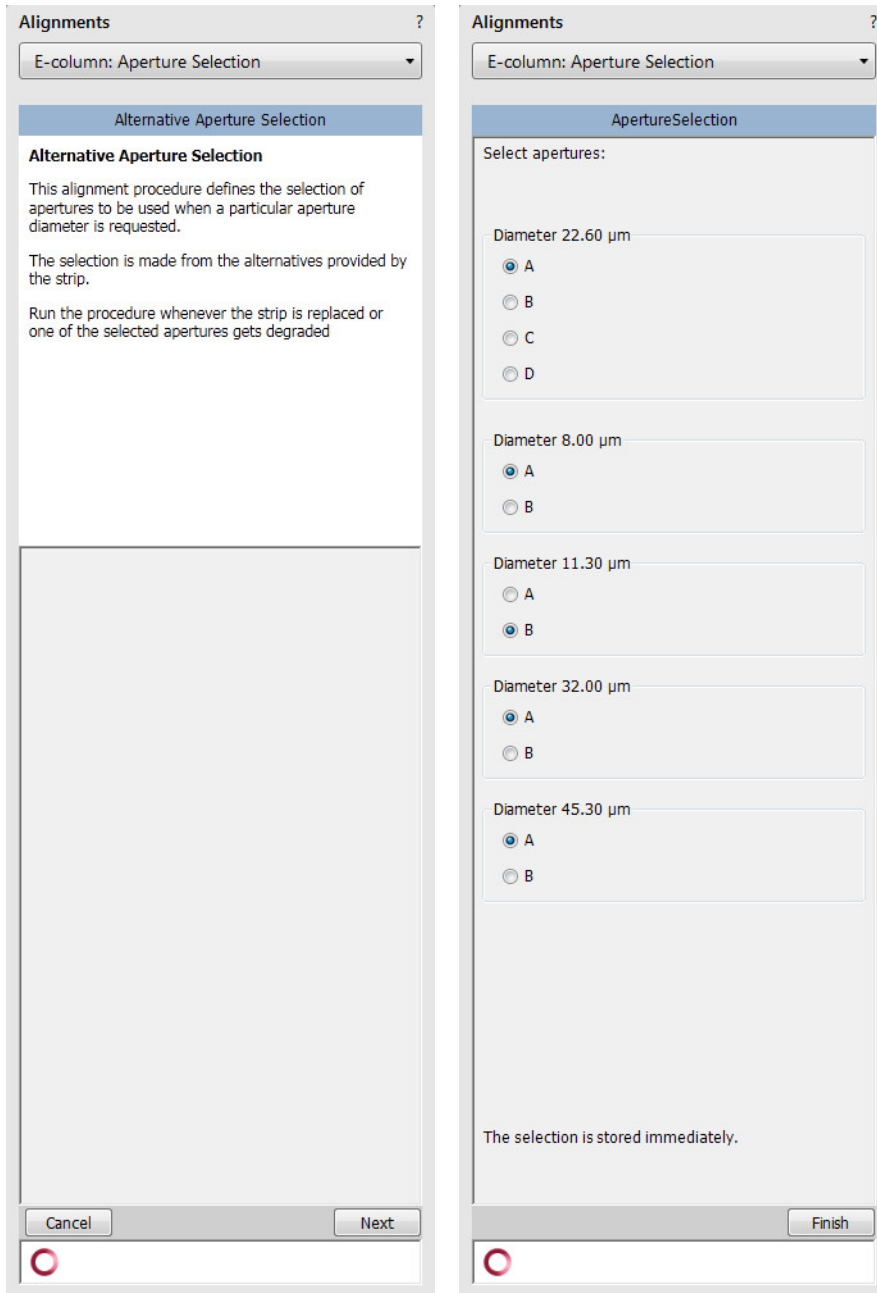
## Note

Switch the Beam menu / Magnification Correction item on only for calibrated conditions. Otherwise it can worsen magnification accuracy.

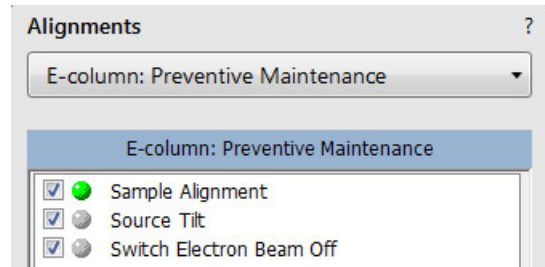


## E-Column: Aperture Selection

The aperture holes edges' cleanliness is very important. If an imaging is poor, try to select an alternative aperture.

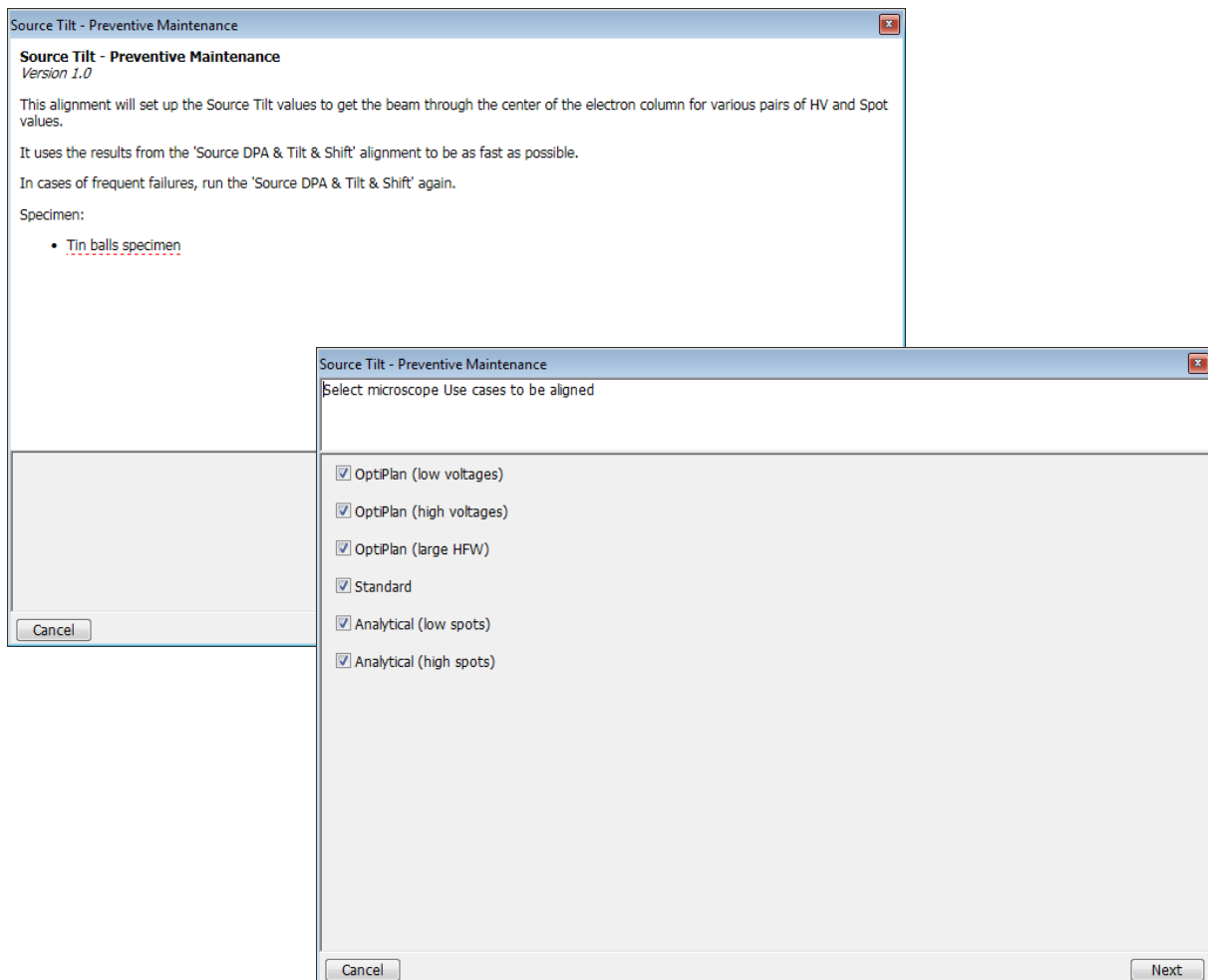


## E-Column: Preventive Maintenance



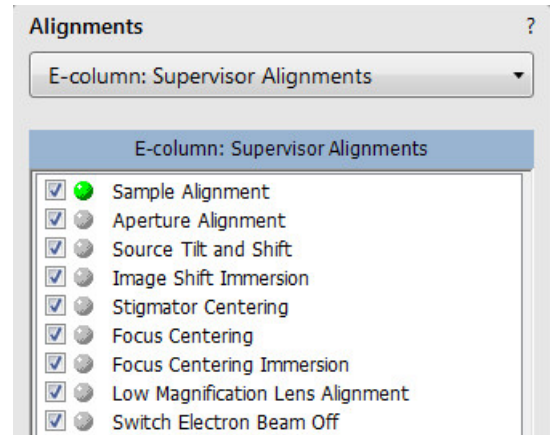
### Source Tilt & Shift (Fast)

This user level alignment ensures centering the electron beam in the column. It should be executed regularly (on a weekly basis). It takes around 15 to 20 minutes. If it is not successful, run the supervisor level alignment *Source DPA & Tilt & Shift*.



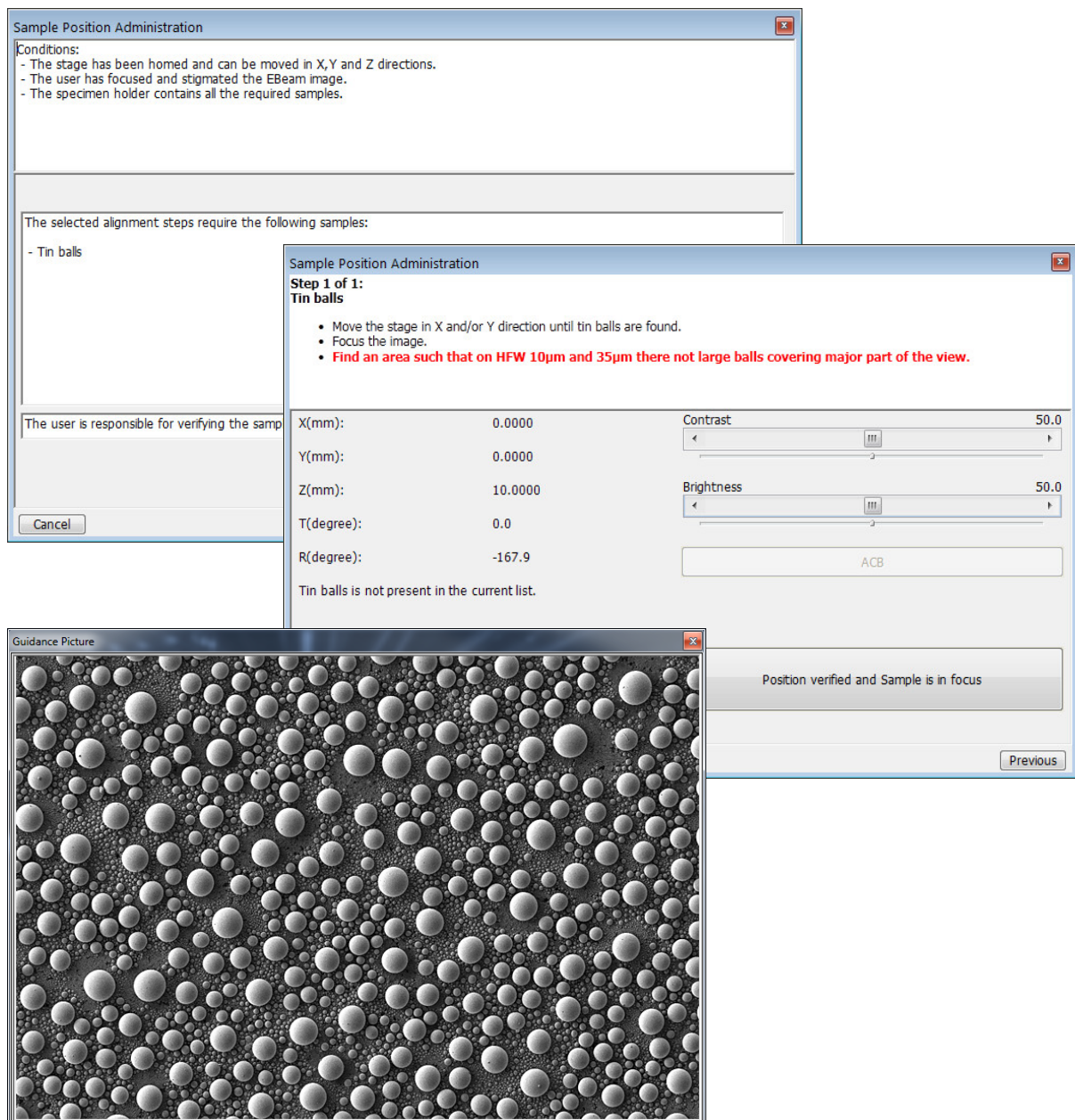
## E-Column: Supervisor Alignments

This set of alignments enables the following actions:



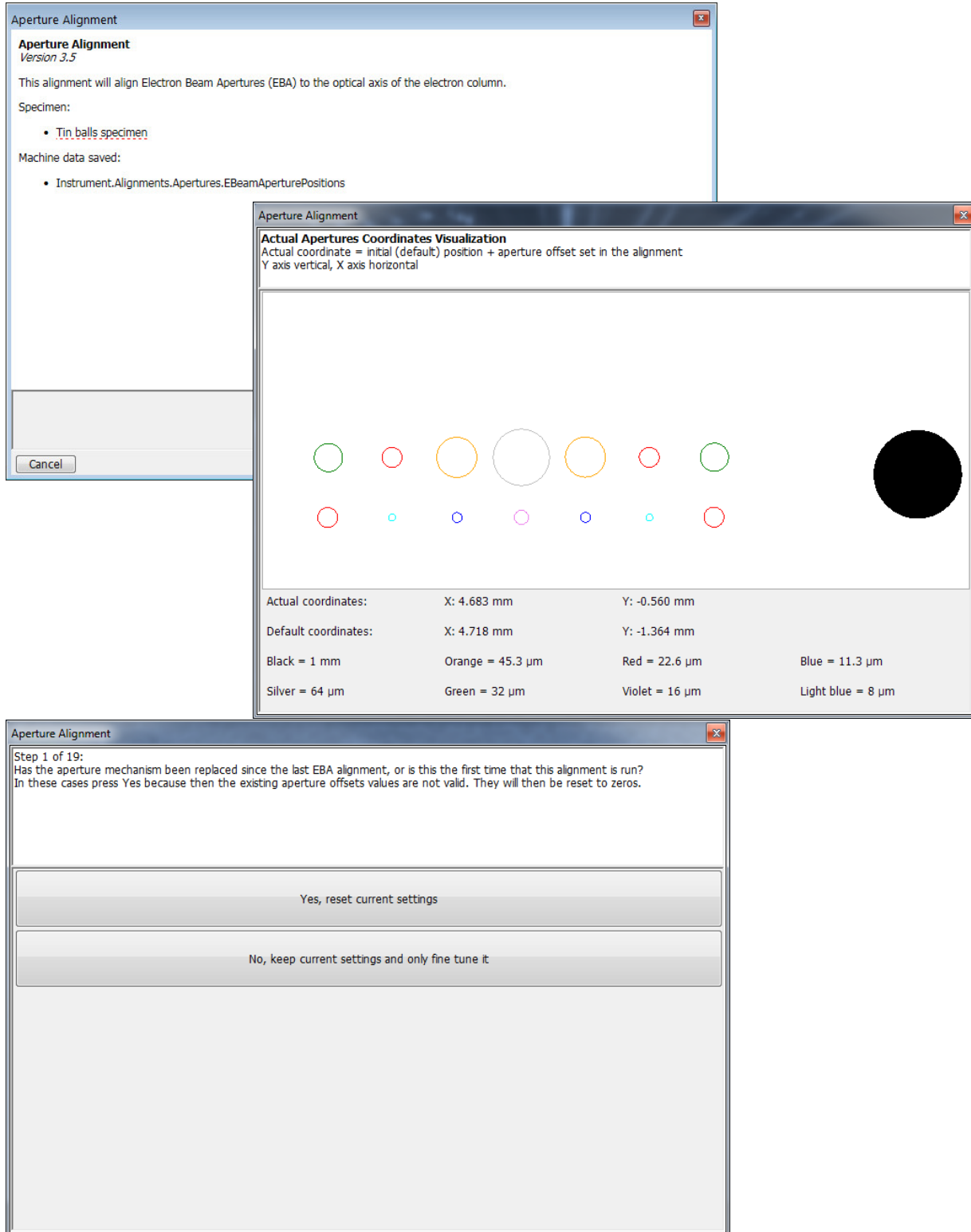
### Sample Alignment

First alignment of this set allows a user to find appropriate sample locations within the sample holder and save them. These positions are used in the following procedures.



### Aperture Alignment

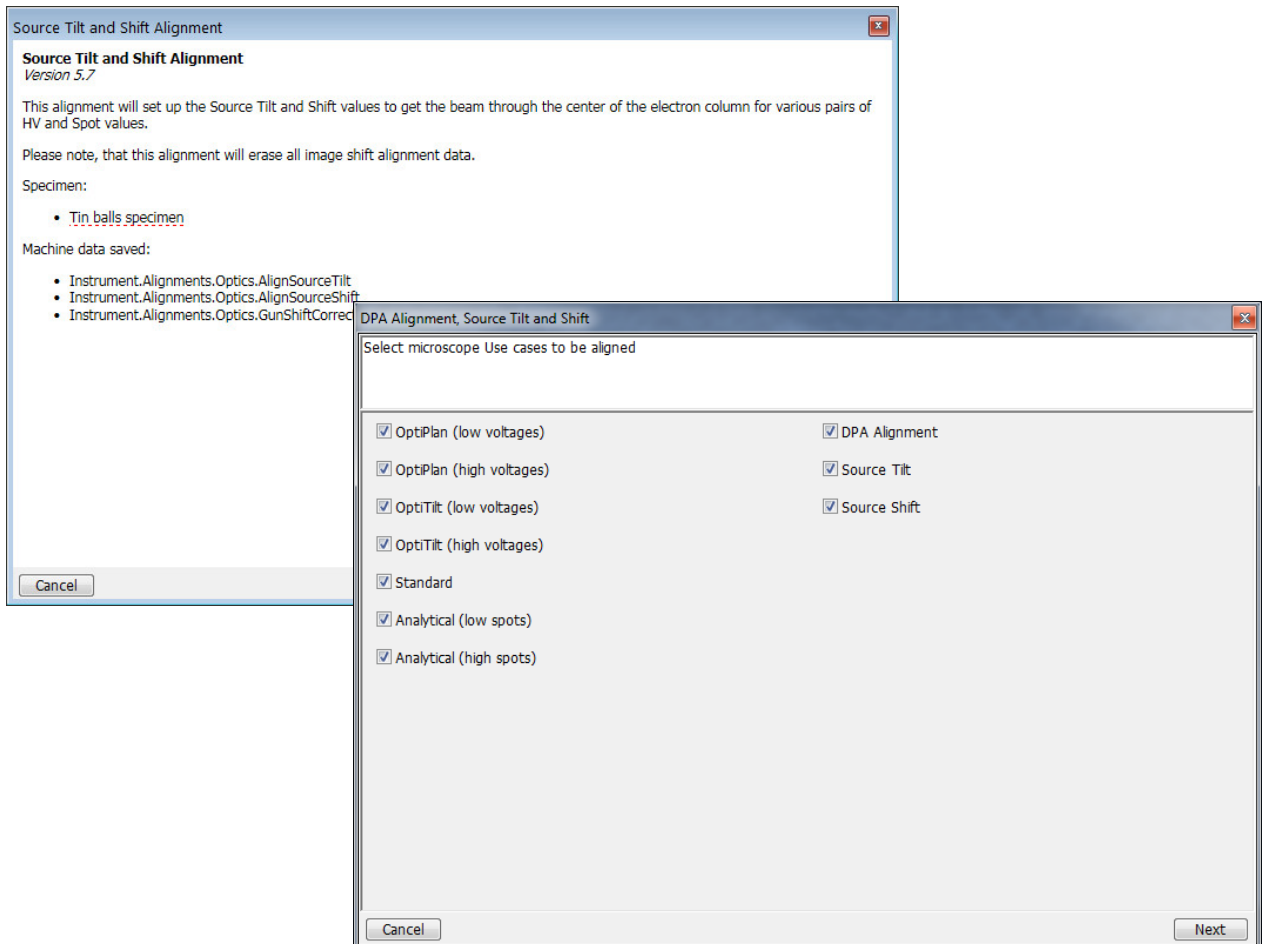
This procedure mechanically centers different electron apertures (on the aperture strip module) in the column.



**Source Tilt & Shift**

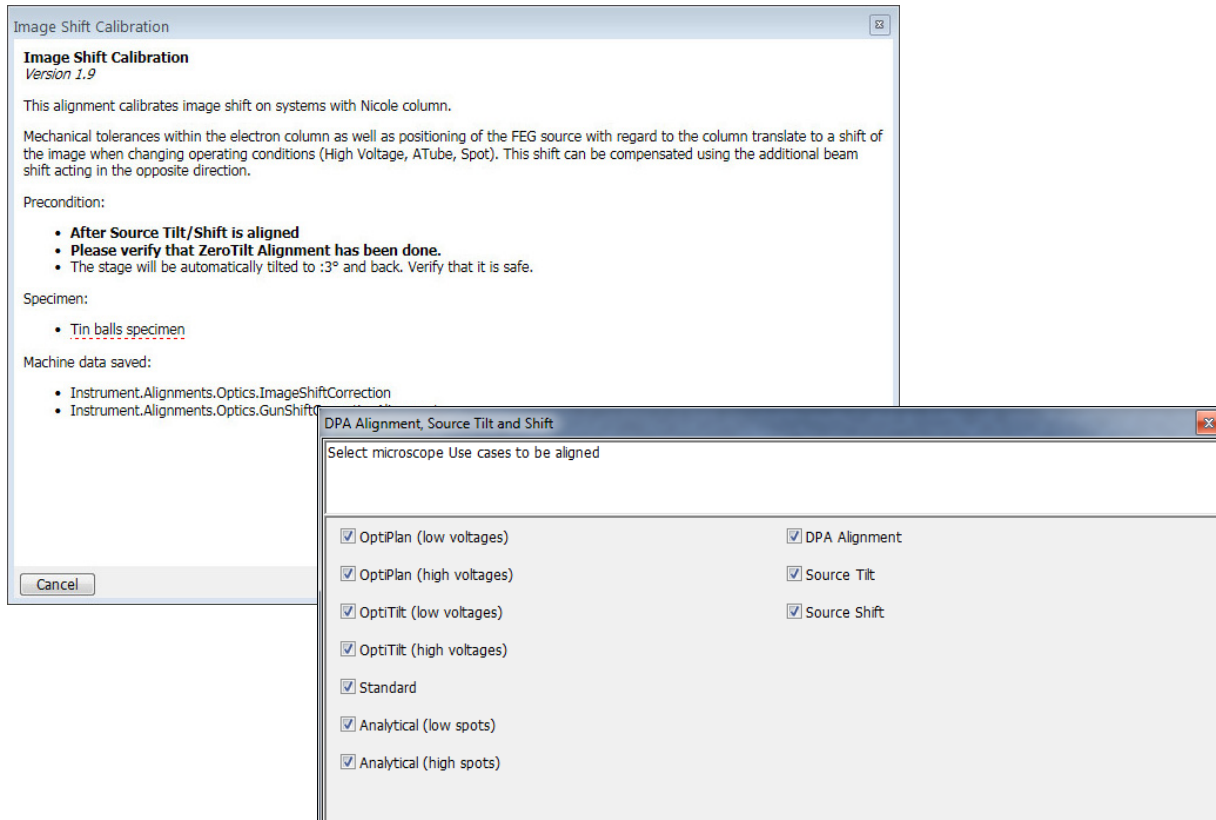
This procedure takes from 2 to 3 hours and should be executed when necessary. It centers the electron beam in the column using three variables:

- *DPA* (Differential Pumping Aperture – separates the high vacuum column part from the chamber vacuum) – centers the electron beam to pass through the column without any cutoff.
- *Tilt* – centers the beam on the optical axis.
- *Shift* – centers the beam on the center of the final lens.



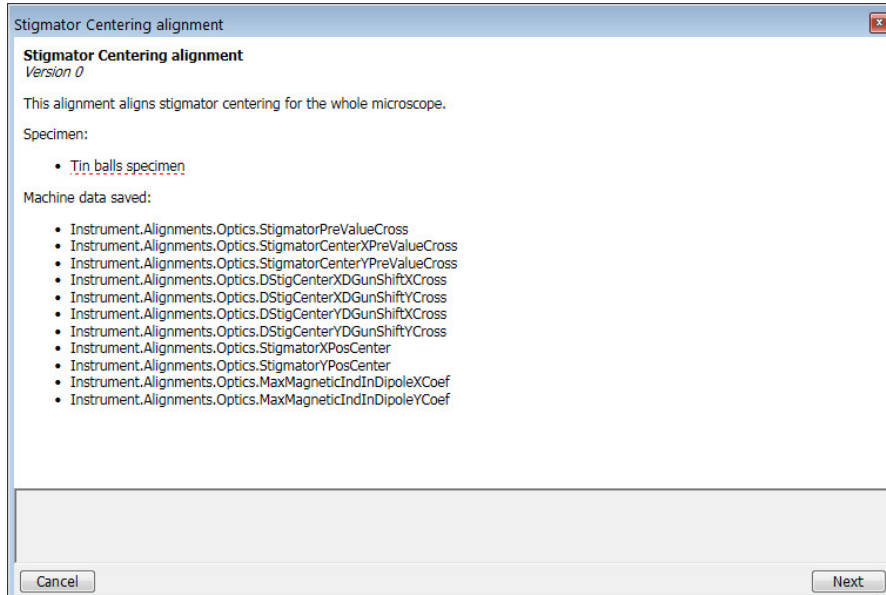
## Image Shift

Correct imaging shift when changing the accelerating voltage and/or Use case.



## Stigmator Alignment

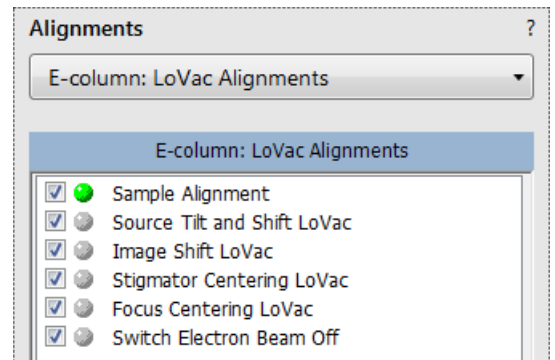
Correct imaging shift when changing the accelerating voltage and/or Use case.



## E-Column: LoVac Alignments

---

This set of alignments enables the following actions:



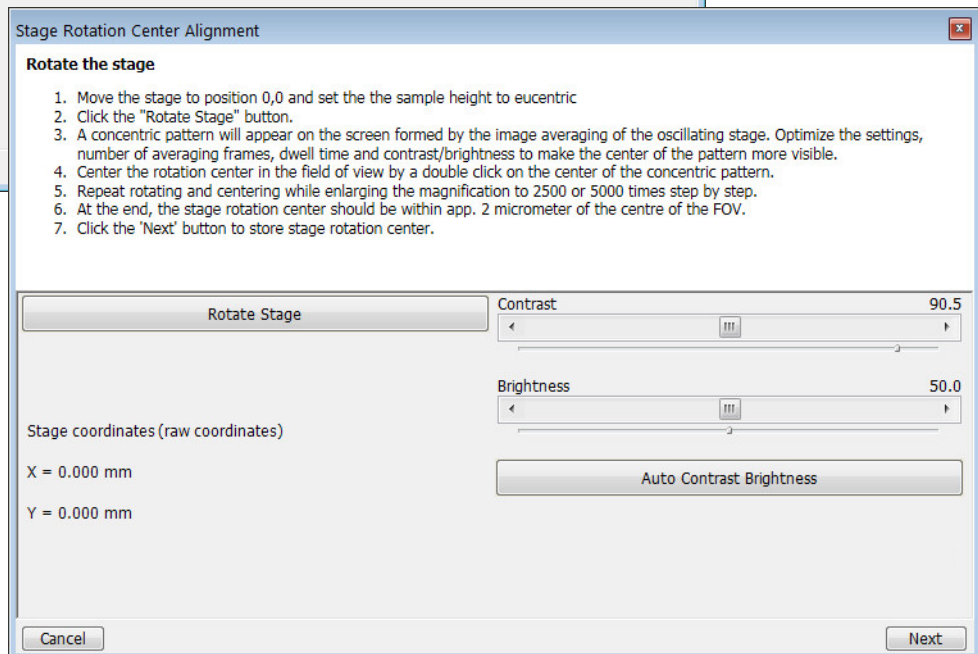
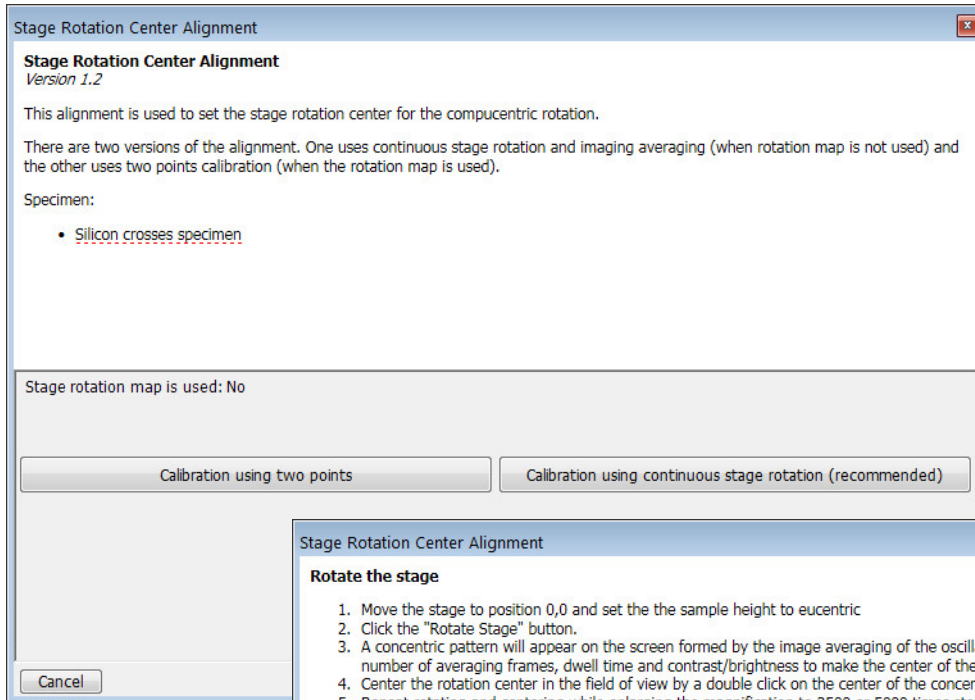
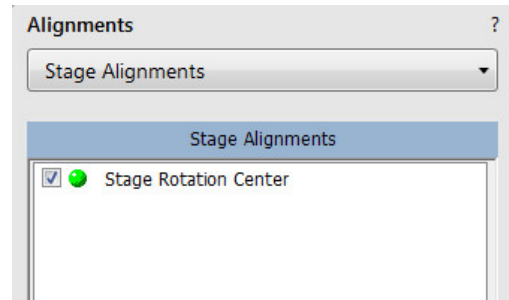


# Stage Alignments

## Stage Rotation Center

The stage rotation has a mechanical center. It is controlled by the Stage module / R value: the stage moves around its mechanical center. In some cases, this is not desired, because a rotation around the field of view center would be more useful – use this alignment to set this situation.

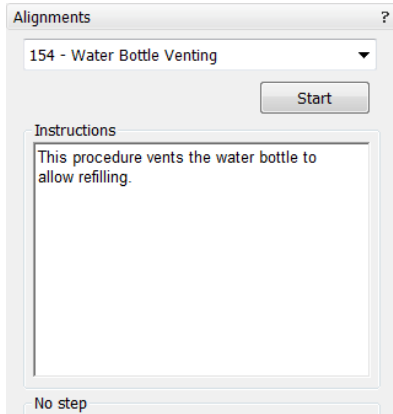
Make sure the stage tilt is zero during alignment. The magnification should be from 500× to 2 000×, and the sample should have a well recognizable feature at least 10 mm from the center to improve accuracy.



# 154 - Water Bottle Venting

---

See Chapter 6.



## Plasma Cleaning / External Plasma Cleaning

When repeating the *Tools* menu / *Sample Cleaning* procedure is not effective, click on the *Start / Stop Chamber Cleaning* button to start / stop the procedure. Its *Duration* is much longer.

If a longer plasma cleaning time is needed, we recommend using several shorter plasma cleaning cycles separated by pumping the chamber down to HiVac mode. Residuals created during plasma cleaning are pumped away, and the following plasma cleaning is more effective. Adjust the *Cycle duration*, *Clean cycles* and *Pumping time between cycles*.

### Note

If there is an external Evactron plasma cleaner, follow the *External Plasma Cleaning* alignment instructions and the *Evactron* user manual!

The image displays two screenshots of a software interface for plasma cleaning. The left screenshot shows the 'External Plasma Cleaning' dialog box. It includes a dropdown menu for 'External Plasma Cleaning', a version number '1.0', a description of the procedure, a warning to retract EDX and use an FEI approved collimator, and steps for preparing and recovering the chamber. The right screenshot shows the 'Plasma Cleaning' dialog box. It includes a warning to retract EDX and use an FEI approved collimator, instructions on setting cycle duration, number of cycles, and pumping time, and a 'Start / Stop Chamber Cleaning' button. Below this are fields for 'Current cycle time', 'Total time', and 'Last Executed'. At the bottom, there is a 'Sample Cleaning' section with a 'Duration (s)' field set to 60.

### WARNING!

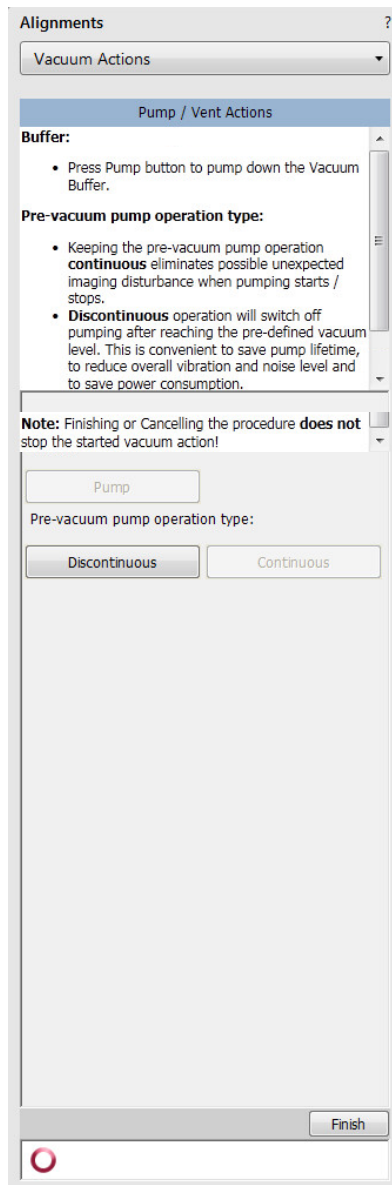
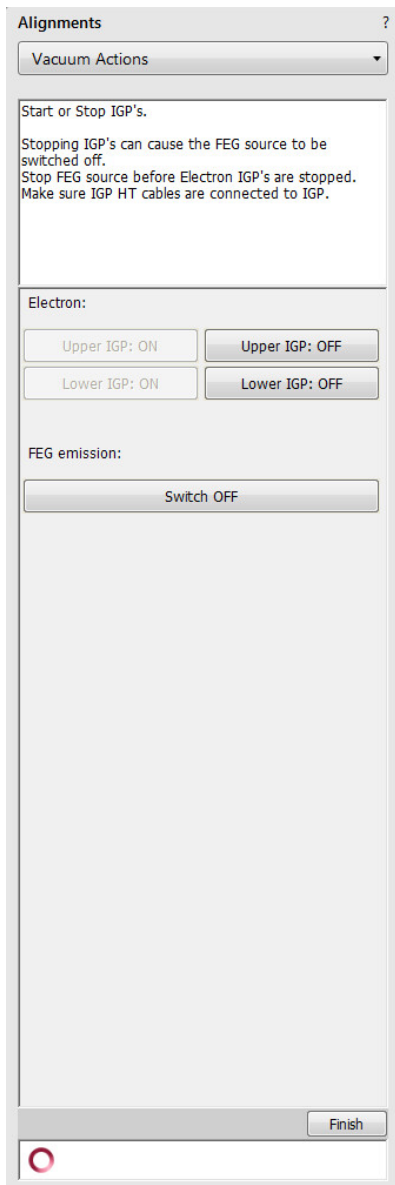
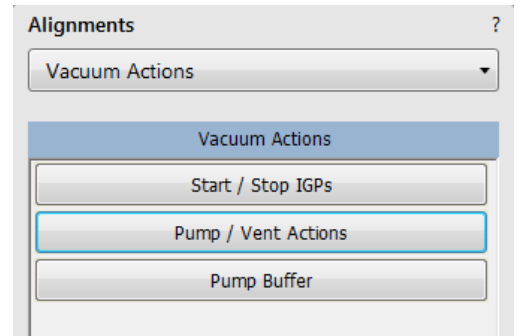
**Do not use Chamber cleaning when the EDS / WDS / EBSD system is mounted! If you need to clean the system with an EDS detector mounted, use a 1 mm collimator and do not exceed 30 minutes once a week at most.**

**Do not exceed 30 minutes of chamber cleaning once a week at most when the DBS detector is installed.**

**Do not leave sensitive samples (including Au-C resolution test samples) in the chamber during the Chamber Cleaning (they may be damaged).**

# Vacuum Actions

- Start / Stop IGP's
- Pump / Vent Actions
- Pump Buffer



## GIS Alignment (option)

The *GIS Port #*: area shows the particular GIS controls.

Change the target crucible temperature for a particular GIS by the *GIS Port # Temperature [°C]* slider.

Click on any of the *GIS Port # Reset Lifetime* buttons to reset the corresponding GIS lifetime records.

**Alignments** ?

GIS Alignment

**GIS Alignment**

**GIS Alignment**  
*Version 1.0*

**Possible actions:**

- Set the temperature
- Reset the lifetime counter

**GIS Port 1: Pt dep**

GIS Port 1 Temperature [°C] 45.0

<

|||

>

Lifetime: 00:00:00 GIS Port 1 Reset Lifetime

**GIS Port 2: C dep**

GIS Port 2 Temperature [°C] 30.0

<

|||

>

Lifetime: 00:00:00 GIS Port 2 Reset Lifetime

**GIS Port 3: W dep**

GIS Port 3 Temperature [°C] 55.0

<

|||

>

Lifetime: 00:00:00 GIS Port 3 Reset Lifetime

Cancel
Finish

○

This chapter describes how to use the Microscope system from an application point of view. The following subjects are covered:

- Specimen preparation and handling
- Optimizing imaging
- Standard detectors
- Capturing and handling a Single image
- Recording movies (saving multiple images)
- Stage control
- Measurement and annotation functions
- Patterning & milling

**Caution!**

*These procedures assume you are familiar with the xT microscope Server and Microscope Control software (see Chapter 3), which are necessary to start and operate the microscope.*

## Specimen Preparation and Handling

---

The sample material must be able to withstand a high vacuum environment without outgassing. It must be clean and conductive. Oil, dust, or other materials may cause sample charging or contaminate the chamber, which could hinder or even prevent evacuation.

### Note

*Always wear lint- / powder-free clean room gloves when handling anything inside the specimen chamber to minimize oils, dust, or other contaminant pollution of the chamber environment.*

## Needed Items

---

- Class 100 clean-room gloves
- Specimen stubs and conductive adhesive material
- Tweezers
- 1.5 mm hex wrench
- Prepared sample

## Natural Specimen

---

If no coating is desired, the Low Vacuum mode can be used to stabilize the specimen for observation. This mode is useful if there is a suspicion that a coating might alter the specimen.

## Coated Specimen

---

If the specimen is nonconductive (plastic, fiber, polymer or other substance with an electrical resistance greater than  $10^{10}$  ohms), the specimen can be coated with a thin conductive layer. This conductive layer reduces beam stir due to sample charging and improves imaging quality.

For successful imaging, rough surfaced specimens must be evenly coated from every direction. Biological, cloth and powder specimens may require carbon or other conductive painting on portions of the specimen that are hard to coat.

Coating makes the imaging sharper and reduces beam penetration. It may mask elements of interest for X-ray analysis (thus the use of carbon for geological and biological specimens).

For more information on specific preparation techniques, see *Scanning Electron Microscopy and X-Ray Microanalysis*, 3rd ed., by Joseph Goldstein et al., Springer, 2003.

## Mounting Specimen on Holder

---

Wafers and PGA devices have individual sample-mounting procedures. If you are using a wafer piece or other sample, attach the specimen to the specimen holder using any suitable SEM vacuum-quality adhesive, preferably carbon or silver paint. The specimen must be electrically grounded to the sample holder to minimize specimen charging. If you are using another method to mount a specimen, make sure the specimen is conductively attached to the holder.

### Note

*The sample holder is not directly grounded to the chamber ground because it is connected to the BNC feed, allowing measurement of the specimen current.*

### **Caution!**

*Store samples and sample holders in a dry nitrogen storage cabinet. Dust on samples can get drawn into the electron column, degrading performance and requiring an Thermo Scientific Customer Service call to correct the problem.*



## Specimen Baking Unit

The Specimen baking unit is intended to bake out the microscope specimens (up to 60 mm diameter) mounted on the specimen holders.

### Caution!



*Read and follow all following instructions carefully!*

*Read and follow instructions stated in the Apreo User safety manual carefully!  
(installed with your Microscope control software)*

*Place the instructions in a safe place for future reference.*



*Note the safety labels and engravings on the baking unit. Read them and be careful to understand their meaning!*

*Do not allow anyone who has not read and understood these instructions and who cannot follow them to operate and/or service the Specimen baking unit!*



*Failure to comply with the precautions and instructions provided with this unit can result in bodily injury and property damage from hazards of fire or burn.*

### WARNING!



*Do not leave the unit unattended when it is ON!*

*Do not open the lid when the unit is ON! Be extremely careful to avoid bodily injuries from burning.*



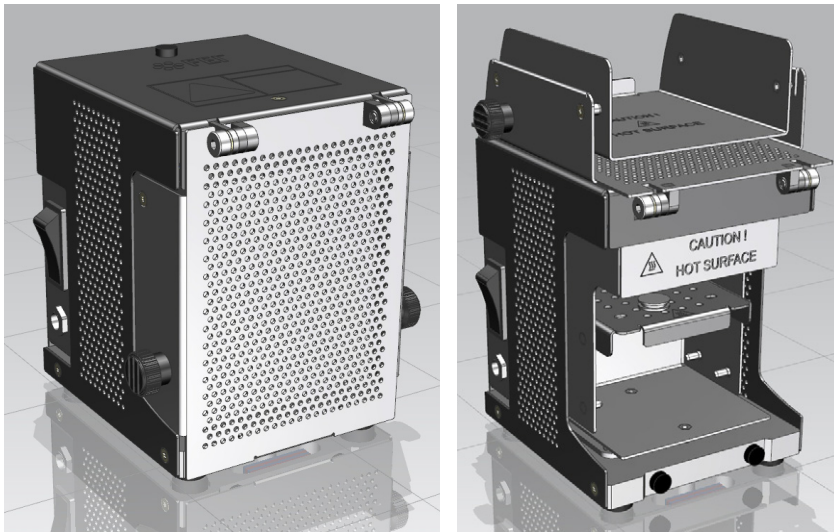
*When opening / closing the lid, always use the plastic knobs, otherwise there is risk of burning!*

*When replacing the halogen bulb, always wear protective gloves and safety goggles!*

### Warranty disclaimer

*The unit must not be used for any other purposes than what it is intended for. Otherwise the warranty claims cannot be accepted.*

**FIGURE 5-1:** Baking unit / Baking unit with opened lid



### Installation instructions

The unit should be placed away from flammable materials.

Do not put any objects on top of the unit - the unit becomes warm when in operation.

The unit is supplied with 12 V DC. The adaptor has a replaceable plug to fit in various mains sockets. Connect the supply voltage cable connector to the unit and plug the adaptor into the mains voltage of 110 - 230 V AC.

**FIGURE 5-2:** Power supply adaptor with removed plug / with mounted plug



### Operation

The inner surface of the unit is polished and vacuum-clean. Avoid contamination of the inner surface otherwise the specimens may become contaminated during the baking cycle.


### Caution!

*Always wear clean lint-free gloves when handling the unit and the specimens! Be sure the working desk is free from impurities that can cause the unit or specimen contamination.*

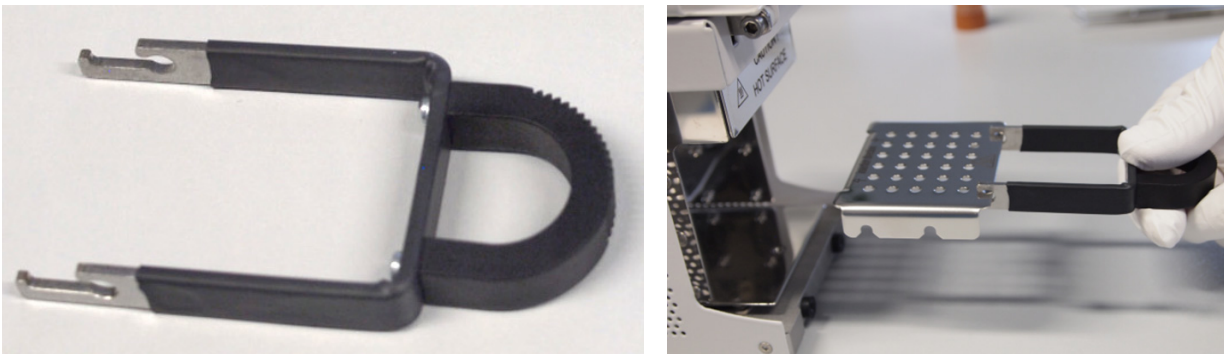
*The working desk must be covered with a material with a melting temperature higher than 250 °C!*

### WARNING!

*Do not look directly at the operating bulb for any period of time! Doing so may cause serious eye injury.*

 *Risk of burning! For support tray manipulation (sample loading, for instance), always use the special tool delivered! Never touch the inner surface of the baking unit, including the trays and specimens, with bare hands or hands in gloves.*

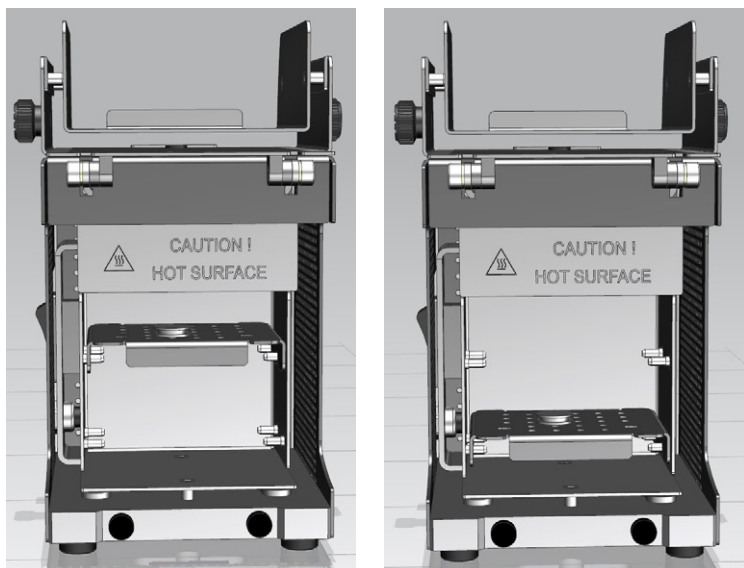
**FIGURE 5-3:** Support tray Handling tool / Removal of the Support tray



1. Open the lid and remove the support trays from the unit using the special tool.
  2. Put the support tray on the working desk and put one or more specimens on it so that the specimen stub pin enters the hole in the tray.
  3. Put the tray back in the unit and close the lid.
- There are two possible slots for tray insertion. The specimen will be exposed to a temperature of 160 °C in the upper position and of 120 °C in the lower position.



**FIGURE 5-4:** Support tray mounting positions



4. Press the rocker switch on the unit to switch the unit ON.
5. Wait at least 3 hours. Switch OFF the unit by pressing the rocker switch.
6. Carefully open the lid, remove the tray with the specimens, and put it on the working desk.
7. Carefully hold the specimen with a pair of tweezers and mount it in the microscope chamber while hot.
8. Start the pumping cycle right after mounting a sample into the microscope chamber.  
To make the baking process most efficient, we recommend mounting the sample in the microscope chamber immediately after stopping the baking cycle. Let it cool down to the room temperature inside.

*Note*

*For high resolution observation, let its temperature stabilize for approximately 30 minutes.*

**Maintenance**

The unit does not require any maintenance except necessary cleaning. When cleaning the unit, use vacuum compatible cleaning agents (isopropyl, ethanol) and lint-free tissues. The support tray can be cleaned in an ultrasonic bath.

**Caution!**

*Do not clean the Baking unit in the ultrasonic bath!*

**Halogen bulb replacement**

**WARNING!**



*The bulb operates at extremely high temperatures that can cause serious physical injuries and property damage! Never touch bulb when it is on, or soon after it has been turned off, as it is hot and may cause serious burns!*

*When replacing the halogen bulb, always wear protective gloves and safety goggles!*

**Caution!**



*The bulbs are very fragile. Do not drop, crush, bend or shake them! Vibration or impact will cause filament breakage and short bulb life.*

*Do not touch the bulb surface with your bare hands! Use clean gloves or lint-free cloth for installation and removal. Oils from skin can lead to breakage or shorten the life of the bulb.*

*Do not use any other type of the bulb than specified, as it could cause overheating of the baking unit or inefficient sample baking.*

1. Press the rocker switch on the unit to switch the unit OFF. Wait until the bulb is cooled down completely.
2. Remove the bulb from the baking unit.
3. Insert the new bulb into the baking unit.

You can use spare bulb delivered together with the unit. Always use only bulb with the following specification:

Type:	Low voltage halogen bulb, G4, 12V, 20W
Supplier:	OSRAM
Product ID:	64428

# Microscope Control

It is assumed that the microscope is in its Full operation state (see Chapter 2).

## Operation Pre-Check

To ensure correct operation check the following list before continuing. After obtaining a preliminary image, you can then experiment with your own settings.

**Table 5-1:** Apreo setup conditions

<b>Adjustment</b>	<b>Electron Beam Setting</b>
<b>Vacuum mode</b>	<i>High Vacuum:</i> conductive samples <i>Low Vacuum:</i> nonconductive, mixed or contaminating samples
<b>Column Use Case</b>	Standard
<b>Accelerating Voltage</b>	Select voltage relative to the specimen type: - low kV for surface imaging, beam-sensitive samples and slightly charging samples - high voltage for conductors, high resolution, composite info (BSE, X-ray) Examples: - biological samples HV = (1 - 10) kV - metal samples HV = (1 - 30) kV
<b>Beam Current Spot size</b>	100 pA at 30 kV <i>High Vacuum / Low Vacuum:</i> 5 - 6
<b>Scan rate</b>	<i>High Vacuum:</i> fast scan (dwell time 0.1 - 0.3 $\mu$ s) <i>Low Vacuum:</i> slow scan (dwell time about 3 $\mu$ s)
<b>Working Distance (FWD)</b>	Set the highest specimen point to approximately 10 mm (yellow mark in an optical imaging display), tilt to 0° and press Ctrl + F (set FWD to 10 mm function).
<b>Eucentric Position</b>	10 mm
<b>Magnification</b>	Set to lowest, from 20× to 200×
<b>Standard Detector</b>	<i>High Vacuum:</i> ETD (SE) <i>Low Vacuum:</i> LVD
<b>Filtering</b>	<i>High Vacuum:</i> Average (2-4 frames for fast scans) <i>Low Vacuum:</i> Live
<b>Contrast and Brightness</b>	With contrast at the minimum value, adjust the brightness to just show a change in intensity on the screen. Increase the contrast to produce reasonable imaging. Increasing brightness and decreasing contrast produce softer imaging and vice versa.

## Inserting / Exchanging Specimen

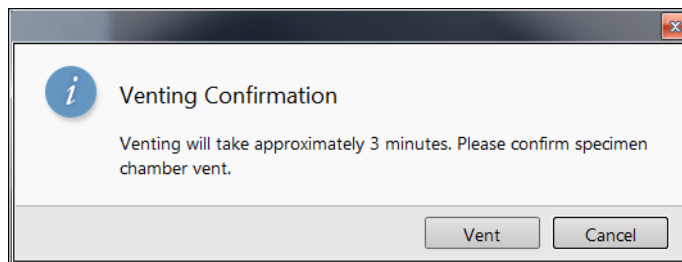
1. Click on the *Vacuum* module / *Vent* button. The confirmation dialog appears. After switching High Voltage off, the vacuum system switches off the pumps and opens appropriate valves to vent the system. After a specified venting time, the venting valves will close.

**Note**

*If the venting valve closes before the chamber is at the atmospheric pressure (it is not possible to open the door), click on the Vent button once more to open it again.*

2. When vented, open the specimen chamber, and using lint-free gloves or tweezers, place a specimen into the specimen holder.
3. Close the specimen chamber door and click on the *Vacuum* module / *Pump* button.

Instructions for a sample exchange are also shown within the informational window by clicking on the toolbar icon.



## Selecting Vacuum Mode

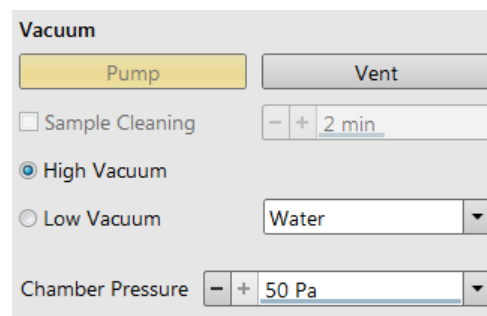
When a specimen and appropriate detector(s) are installed correctly, continue the procedure (see above):

4. Check the *High Vacuum* module / *Low Vacuum* or *High Vacuum* mode radio button.

For the Low Vacuum mode select the appropriate gas from the drop down list and the target *Chamber Pressure* to pump the system to.

**WARNING!**

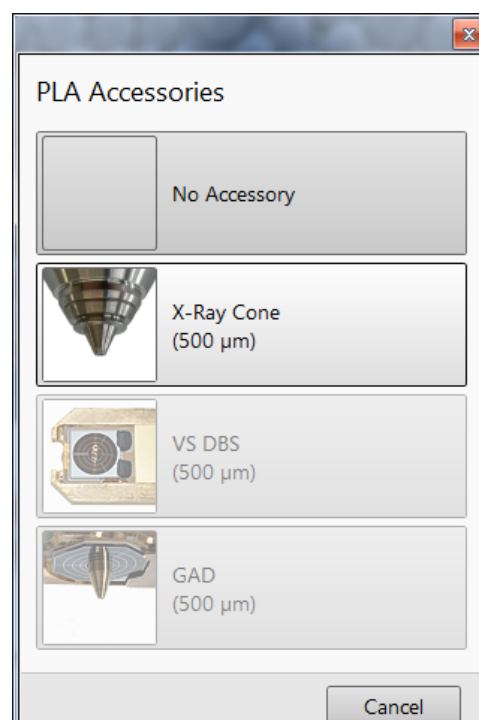
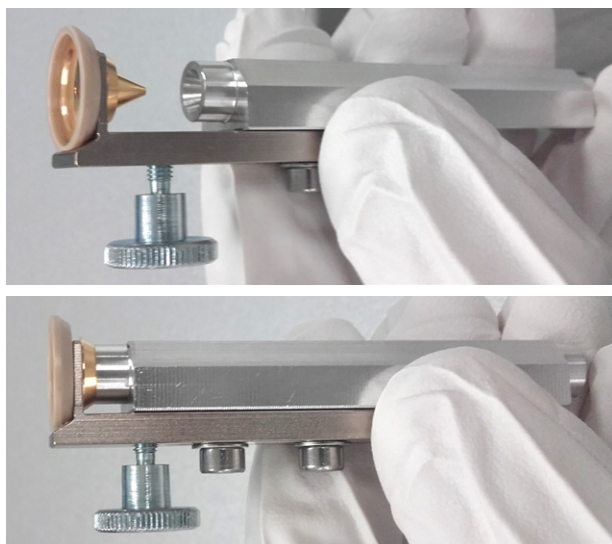
*The system can be damaged by using the Low Vacuum mode without an appropriate PLA. Do not select a PLA Cone that is not actually being used (see Chapter 2)!*



## X-Ray Cone Mounting / Dismounting Procedure

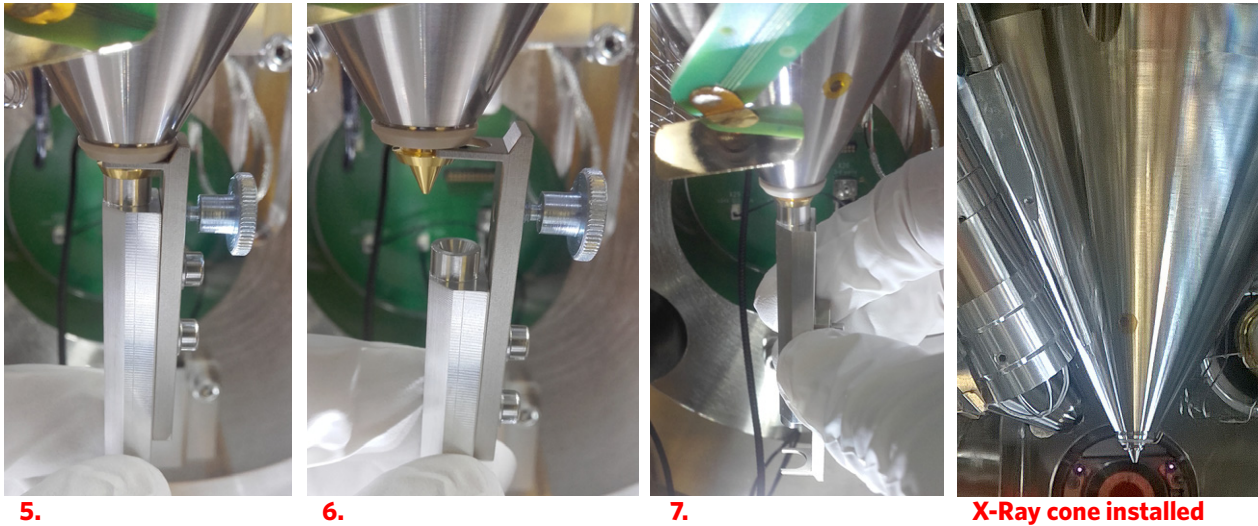
Under normal operation, the system will know the PLA cone size for the detector installed in the LoVac mode. This will allow the system to set automatic pressure range limits for the aperture installed, thus avoiding vacuum errors when setting the chamber pressure.

The X-Ray cone is stored in the provided installation tool. The large arresting screw releases the working part so it can slide along its skid.





**FIGURE 5-5:** X-Ray Cone mounting Procedure



To mount the X-Ray Cone follow this procedure:

5. Push the cone attached in the tool to the final lens pole in its axis direction.
6. Release the arresting screw, slide the working part down, and pull the tool to the side.
7. Turn the tool by 180° and push the cone again to ensure it is sealed well.

To dismount the cone, follow steps 5. and 6. in reverse.


**Note**

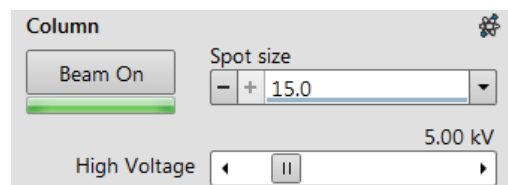
Do not touch the cone or the mounting tool by hand. Store it attached to the mounting tool in a clean plastic bag.

8. Select an appropriate cone and click the Vacuum module / Pump button. While pumping, choose the highest specimen point and bring it to the 10 mm Working Distance (yellow line in optical display).

## Imaging Onscreen

Continue the procedure:

9. When the vacuum status is PUMPED (see the status bar), click on the Column module / Beam On button to ramp up the electron beam acceleration voltage.
10. Select an appropriate column Use case, detector and release the active display (if paused), where the image appears.
11. Focus the imaging and Link Z to FWD. 
12. Adjust to a suitable magnification. Optimize the imaging using the Contrast & Brightness, Focusing, Astigmatism Correction etc.



# Optimizing Imaging

## Principles of SEM Imaging

All scanning beam microscopes share the same fundamental technique. The primary beam is scanned across the specimen surface in a regular pattern called raster. Normally, this raster consists of a series of lines in the horizontal (X) axis, shifted slightly from one another in the vertical (Y) axis. The lines are made up of many dwell points and the time of each dwell point can be shortened or prolonged (dwell time). The number of points per line can be increased or decreased as well as the number of effective lines. The result is a picture point (pixel) array. Low or high resolution imaging can be obtained by changing these factors. The larger the pixel array, the higher the image resolution. The image is created pixel-by-pixel in the computer memory and shown on a monitor screen.

The signal emitted by the specimen surface as it is illuminated with the primary beam is collected by the detector, amplified and used to adjust the intensity of the corresponding pixel. Because of this direct correspondence, the pixels shown on the monitor are directly related to the specimen's surface properties.

The raster consists of many (typically one million) individual locations (pixels) that the beam visits. As the beam is scanned, the signal emitted by the sample at each beam position is measured and stored in the appropriate digital memory location. At any time after the beam scan, the computer can access the data and process it to change its properties, or use it to generate an image.

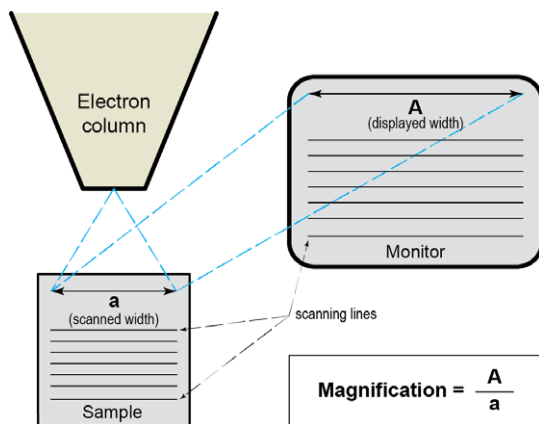
## Magnification

*Magnification* is calculated as the shown dimension (L) divided by the sample scanned dimension (l).

If the observed sample area is made smaller while the monitor size remains constant, the magnification increases. At low magnification, one gets a large field of view. At high magnification, only a tiny sample area is imaged.

It is possible to set a corresponding databar magnification readout in the Quad Image and Single Image modes and in the saved image (see the *Preferences / Magnification* section).

**FIGURE 5-6:** Scanned sample and monitor imaging



## Changing Magnification

- *Toolbar* list box - used to choose from predefined values
- *Keyboard* control (+ / - / \*) - the numeric pad plus key (+) / the minus key (-) increases / decreases the magnification 2x and rounds the value. The star (\*) key rounds the magnification value (e.g. 10 063x becomes 10 000x).
- *Mouse wheel* control - coarse / fine control can be operated by the Ctrl / Shift key and rolling the mouse wheel up / down to increase / decrease the magnification.
- *Selected Area Zooming In / Out* - a quick way of zooming in / out on an area of interest. Click inside the imaging area & drag to make a dotted box over the area of interest (the cursor changes to a magnifying glass with a + sign). Release the mouse button, and the selected area increases to fill the whole imaging area with respect to the sides ratio. Clicking on & dragging + Shift consecutively reverses the above described technique (the cursor changes to a magnifying glass with a - sign). The Esc key cancels the operation at any time.
- *Magnification* module
- *Digital Zoom* module

50 ×	▼
100 ×	
500 ×	
1000 ×	
5000 ×	
30000 ×	
100000 ×	
250000 ×	
300000 ×	



## Scan Speed

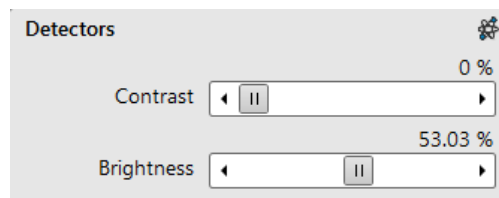
To obtain a good imaging with acceptable signal to noise ratio it is necessary to find a balance among scan speed, sample charging and/or damage.

A noisy image can be improved by decreasing the scan speed. If sample charging and/or damage is the limiting factor(s), it is better to use a higher scan speed in combination with noise and charge reducing tools like *Average* or *Integrate* filter, *Line Integration* or *Scan Interlacing*.

## Contrast & Brightness

The contrast and brightness can be set manually either by adjusting the *Detectors* module controls, using the mouse (Ctrl + click on & dragging – horizontal / vertical direction adjusts the contrast / brightness) or by using the MUI (option):

1. Select a medium scan speed in an active display.
2. Reduce the contrast to zero. Adjust the brightness to a level corresponding with the last gray level detectable by eye before the screen goes black.
3. Increase the contrast until the image of the observed structure appears.
4. If necessary, adjust the brightness level to improve the image.



### Videoscope (F3)



This tool can facilitate contrast and brightness optimization to utilize the full grayscale imaging range.

Three yellow horizontal lines (placed over the display) indicate white (top line), gray (middle line) and black (bottom line) levels. The oscillogram signal amplitude / central position reflects the contrast / brightness of the line just scanned. If the oscillogram is cut by the bottom / top line, the signal level is clipped in black / white. This should be avoided, because imaging details are lost in the clipped areas.

Tuning the oscillogram exactly between the top and bottom lines for a feature of interest (using a reduced area) results in full detailed imaging. Signal clipping may be used to obtain harder contrast conditions when more black and white is needed. Lowering the signal amplitude decreases the contrast, i.e. the imaging looks softer.

1. Select a slow scan in an active display.
2. Activate the Videoscope in an active display (F3 / clicking on toolbar icon / Scan menu) or in all live displays (Shift + clicking on the toolbar icon).
3. Reduce the contrast to zero and adjust the brightness level to the lower dashed line (black).
4. Increase the contrast so that the signal level just touches the upper dashed line (white).
5. If necessary, adjust the brightness level so that the average signal level is roughly in the middle.
6. The high and low peaks should just touch the dashed lines.

Repeating the contrast & brightness optimization helps improve the image quality.



Note



Use also the following functions to optimize the Contrast / Brightness: *Auto Contrast Brightness* (F9), *Display Saturation* (Shift + F11).

## Focusing

Find a feature of interest with distinct edges on a specimen. Use a combination of contrast, brightness and magnification adjustments to optimize the imaging quality.

1. When the mouse cursor is over an imaging area, *right-click on & drag* (the mouse cursor changes to a 2-ended arrow). Move the mouse from side to side until the observed object is sharp, then release the mouse button. 
2. The focus function uses the whole screen without any interference from other controls. If the full mouse motion is not sufficient to get the focus, release the mouse button at one side of the screen, move the mouse cursor to the opposite one, and right-click & drag again over an imaging area to continue focusing. 
3. If necessary (for example when new specimen was loaded), run the *Link Z to FWD* function.

Focusing at a higher magnification makes the result more precise. For example, for an output at the 2 000× magnification, focus at 4 000× – 8 000× magnification.

To avoid scanning too long and contaminating or even damaging the sample before you take the final image, move away from the feature of interest with the X and Y stage controls, and focus until the image is sharp on an adjacent area.

### Focusing with MUI (option)

Use *coarse* and *fine* focus knobs. The imaging immediately responds to the MUI.

Note 


Use also the following functions to focus: *Reduced area (F7)*, *Auto Focus (F11)*.

## Correcting Astigmatism

This optical aberration is caused by different focal lengths for rays of various orientation, resulting in directional imaging blur ("X and Y rays" are not focused to the same plane). It is best seen on the edges of observed sample structures. Stigmator serves for correction of this imperfection, which is usually better seen at higher magnifications (3 000× or more).

When imaging conditions are changed, use the following procedure to correct astigmatism:

1. Focus an image.
2. Bring the imaging just slightly out of focus. The image appears to become sharper in one direction whereas in a perpendicular direction, blur increases (blurring or stretching).
3. Bring the image just slightly out of focus in the other direction to observe the opposite directional blur.
4. Focus to the midpoint between the two directions, where the blur is visible.
5. Use the *Beam* module / *Stigmator 2D* control.

*Mouse:* shift + right-click on & drag while in the active display. This results in a 4-ended arrow cursor appearing in the screen's center. Move the cursor around the screen to achieve maximum sharpness. When you are satisfied, release the mouse button. 

The *MUI* (optional): adjust imaging sharpness with the stigmator X and Y knobs until the best result is achieved.

6. Repeat steps 1–5 as necessary.

If astigmatism is severe and the cross is close to the edge of the screen when nearing correction, release the mouse button and reposition the cross in the center of the screen. Then repeat the procedure above to perform further astigmatism correction. You can advantageously use a reduced area.

If astigmatism cannot be corrected, there may be some other reason. Usually it is that the final lens aperture is dirty (see Chapter 4 - *E-Column: Aperture Selection*), the magnification may be too high for the beam spot size, or the sample is charging (apply a conductive layer or use the Low Vacuum mode).

Note 

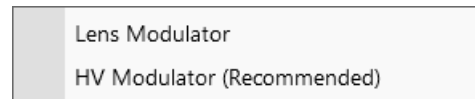
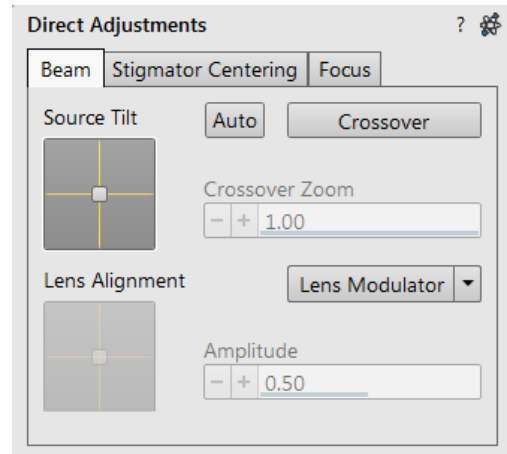
For normal astigmatism correction use the automatic procedure (*Ctrl + F11*).

## Direct Adjustments

This control page serves for fine-tuning the beam geometry to achieve the best focus and brightness.

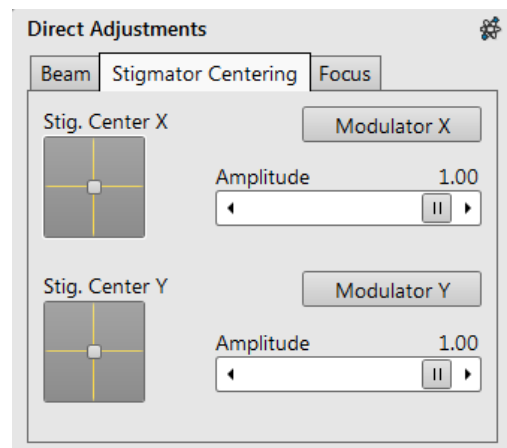
### Electron Beam tab

- Source Tilt 2D box** – serves for correction of signal intensity by changing the effective angle of the beam coming from the source into the electron column.  
 Move the crosshair in order to get the electron beam spot into the display center.
- Clicking the *Auto* button sets the Source Tilt automatically.
- In the *Crossover* mode (activated with the button), the image shows the electron source position instead of the sample surface.
- Crossover Zoom slider** – set the Crossover image magnification.
- Lens Alignment 2D box** – optimizes the primary beam passage through the final lens so that image shift during focusing is suppressed.  
 Try to minimize the image shift by the crosshair movement.
- Lens Modulator** (useful for HV > 3 kV) / **HV Modulator** (useful for HV ≤ 3 kV) button – starts automatic objective current / accelerating voltage oscillation (periodically under- and over-focuses imaging in a narrow range) to facilitate the above mentioned optimization.  
 When the accelerating voltage is above 3 kV, Lens Modulator is automatically selected, otherwise the HV Modulator is. You can choose either one manually.
- Amplitude slider** – sets the modulation amplitude.



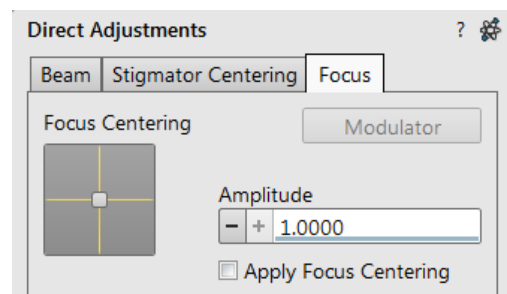
### Electron Stigmator Centering tab

- Stig. Center X / Y 2D box** – serves for minimization of image shift during astigmatism correction. The crosshair indicates the actual stigmator setting.  
 Try to minimize the image shift by the crosshair movement.
- Modulator X / Y button** – starts automatic modulation of the respective stigmator to enable the stigmator centering procedure. Modulation occurs in a narrow range around the current stigmator setting.
- Amplitude slider** – sets the modulation amplitude.



### Electron Focus tab

- Focus Centering 2D box** – serves for minimization of image shifting during focusing if HV ≤ 3 kV. It is a complementary function to Lens Alignment and it is not applied for HV > 3 kV.  
 Try to minimize the image shift by the crosshair movement.
- Modulator button** – starts modulation of the corresponding electron optical components to enable the focus centering procedure.
- Amplitude slider** – sets the modulation amplitude.
- Apply Focus Centering check box** – if selected, the result of the focus centering procedure is applied.



## Digital Imaging Enhancement / Imaging Mixing / Coloring

The Enhanced Image module offers various digital imaging enhancements.

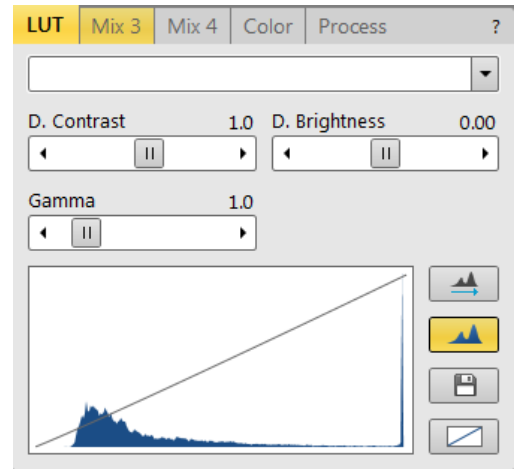
**Note**

When saving an image with the digital enhancements applied, be sure to choose the correct Digital file format (see further).

**LUT (Look-Up-Table) tab module**

enables monitoring and modifying gray level distribution (histogram).

- Presets list box - enables selecting the Digital Contrast, Digital Brightness and Gamma values using pre-defined or custom presets.
- *D. Contrast* adjuster - sets digital contrast in the range from -10 to +10 (negative values lead to an inverse image).
- *D. Brightness* adjuster - sets a digital brightness in the range from -2.0 to 2.0.
- *Gamma* adjuster - corrects image brightness non-linearly in the range from 0.1 to 10.
- *Auto Levels* button - sets the three above mentioned parameters automatically according to the image / image quality.
- *Graph* area - graphically shows the applied modification via the gray line. Horizontal / Vertical axes represents the input / output values.
- *Auto Levels* button - sets automatically *D. Contrast*, *D. Brightness* and *Gamma* to optimize the actual imaging.
- *Histogram* button - switches on / off the gray level distribution (corresponding to the live imaging) illustration. The left / right side corresponds to black / white original image pixels. The height of the blue line is proportional to the number of pixels with the corresponding gray level.
- *Save* button - saves the actual setting as a custom preset.
- *Default* button - restores the default values.



**Mix 3 / Mix 4 tab module**

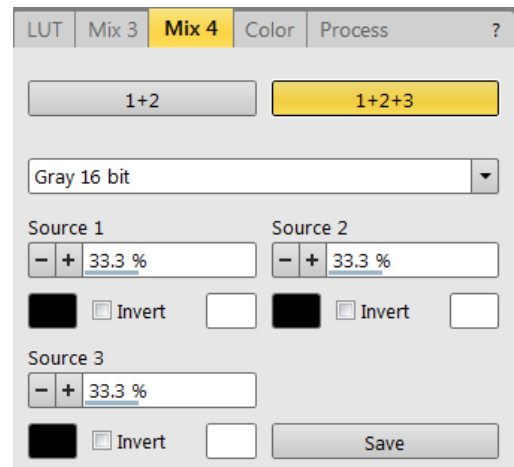
The Mix feature operates in display 3 / display 4 and is automatically enabled when clicking the 1 + 2 / 1 + 2 + 3 button. Any combination of live and paused images can be mixed together, providing all mixed images have the same pixel resolution. However, there are some logical limitations and behaviors related to the Mix display:

- Average and Integrate filters are disabled.
- Pause / Activate functionality influences the mixed imaging only, not its sources. The Mix display is always paused immediately regardless of the actual scanning status.
- Optical imaging is not mixed.

**Note**

In the Mix 3 tab the Source 3 controls and the 1+2+3 button are not available.

- 1 + 2 / 1 + 2 + 3 button - switches on / off mixing of the corresponding displays. It also restores detectors or automatically selects suitable ones in appropriate displays.
- Presets list box - enables selection of the mixing ratios and colors using pre-defined or custom presets.
- Source 1 / 2 / 3 adjuster - tunes the mixing ratio of display 1 / 2 / 3 imaging. The adjuster % value correspondingly influences the resulting image, and the others change automatically to reach the 100% sum.
- Clicking on the *Color* control areas (below each Source adjuster) enables selecting of a color, replacing the source image black (left) / white (right) one. The image grayscale is linearly transformed to a new color spectrum before it is mixed with other image(s).



**Note**

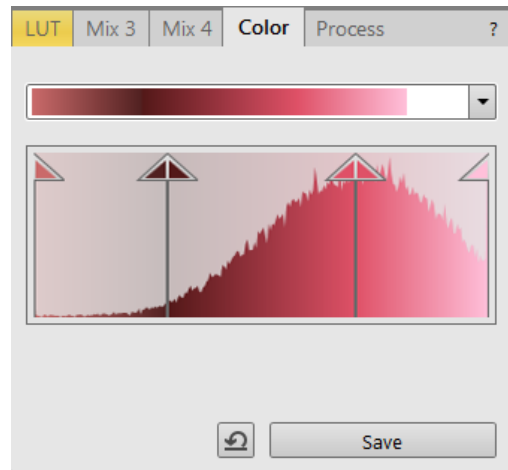
A colorized image (see the Color tab) is converted to a grayscale one before mixing.

- *Invert* check box - inverts a corresponding source spectrum. It has the same effect as exchanging the left and right colors selections.
- *Save* button - saves the actual setting as a custom preset.

**Color tab module**

enables colorizing a grayscale image. An image already colored with the use of the Mix 3 / Mix 4 tab cannot be colored again; the Color tab is disabled.

- *Presets list box* - enables selecting the color profile using pre-defined or custom presets.
- *Coloring Control* area - shows the active display histogram and enables editing a color profile.  
 Clicking on the histogram area adds the vertical borderline with a divided triangle at the top (right-clicking on an existing one removes it). Clicking on & dragging a borderline changes its position along the histogram. Clicking on the left / right part of the triangle selects the left / right border color. The part of the histogram between the two borderlines is linearly transformed to a new color spectrum.
- *Reset button* - sets the modified color profile to its original state.
- *Save button* - saves the actual setting as the custom preset.



**Process tab module**

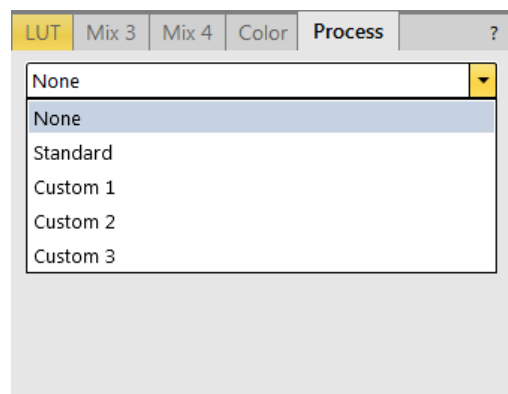
Here a user can set parameters, that are applied to the image when clicking on the *Apply* button, or when selecting the *Tools* menu / *Image Post Processing* (Ctrl + F7).

- *Denoising strength* (Off / 1 / 2 / 3 / 4) - determines the image noise suppression.
- *Sharpening strength* (Off / 1 / 2 / 3 / 4) - influences the image sharpness.

Changes in the *Custom #* presets are saved automatically.

*Note*

*This functionality works only with grayscale images (not colored via the Color tab), images that are paused, or with loaded saved ones.*



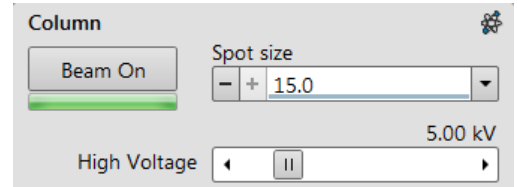
## Accelerating Voltage and Beam Currents

The choice of accelerating voltages - in the UI named High Voltage (HV) - and beam currents for the active display is possible via the toolbar dropdown list boxes. The electron beam current and HV are independent, so any change of voltage will not influence the current.



### Changing High Voltage

Besides a normal list box's behavior an intermediate value can be entered into the toolbar editable HV text box or set by the *Column* module / *High Voltage* adjuster on the Beam control page. This provides a calculated range of beam current / spot values. Default values in the list box are set in the *Preferences* dialog / *Presets* section.



### Electron Beam Current / Spot size

This is one of the basic operating parameters. Functionally, it represents the electron beam diameter (usually presented as the *Spot* size, expressed as a relative number from 1 to 20), the final lens aperture diameter, and its opening angle as set by the condenser. It is considered to be close to ideal when a spot's edges just touch its neighbouring ones. If the spot is too large, overlaps occur and the image appears out of focus. If it is too small, electronic noise appears in the image.

A suitable beam current value for a particular magnification can be determined easily when good focus and astigmatism correction are achieved.

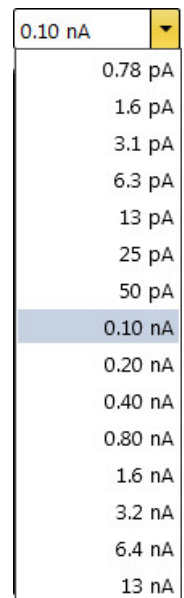
**Table 5-2:** Spot sizes and recommendation of their use

SEM column Use case	Spot size	Best use
<b>Standard / OptiPlan / Immersion</b>	<b>1 - 4</b>	Very low currents, charging and sensitive samples
<b>Immersion</b>	<b>3 - 7</b>	Ultra high resolution
<b>Standard / OptiPlan</b>	<b>4 - 6</b>	High resolution
<b>Standard / OptiPlan / Immersion</b>	<b>6 - 12</b>	Standard imaging
<b>Standard / OptiPlan / Immersion</b>	<b>12 and more</b>	High current imaging, X-ray analysis with SDD detectors
<b>Standard / OptiPlan</b>	<b>10 - 17</b>	High current imaging, X-ray analysis, EBSD detector, cathodo-luminescence
<b>Standard / OptiPlan</b>	<b>18 - 20</b>	Very high currents, fast analysis

### Changing Electron Beam Current

Either electron *Beam Current* or *Spot Size* can be shown within the User Interface. This can be set in the *Preferences* dialog / *General* section or by right-clicking on the toolbar text box and selecting the desired context menu proposal.

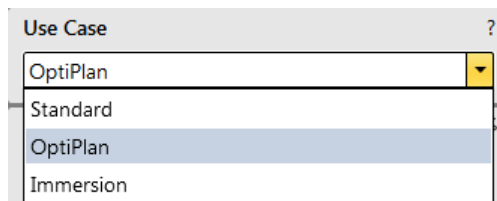
An intermediate value can be set by the *Column* module / *Beam current/Spot size* adjuster on the Beam Control page. Default values in the list box are set in the *Preferences* dialog / *Presets* section.



## Column Use cases

The electron column can be operated in different Use cases optimized for specific applications. To select the desired Use case, use the Use cases module drop down list box.

You can immediately switch from one Use case to another. If high voltage or beam current is out of the operating range of the new Use case, it is set automatically to the closest possible value. If the newly set conditions do not allow imaging, (e.g. it is not possible to focus), transition is not allowed, and a warning is shown in the application status window.



- **Standard**

This is the survey mode ideal for navigating and reviewing sites at lower magnifications. The A-Tube is on the ground potential, and the default detector is the ETD in the Secondary Electron mode. Maximum probe current is limited to 13 nA.

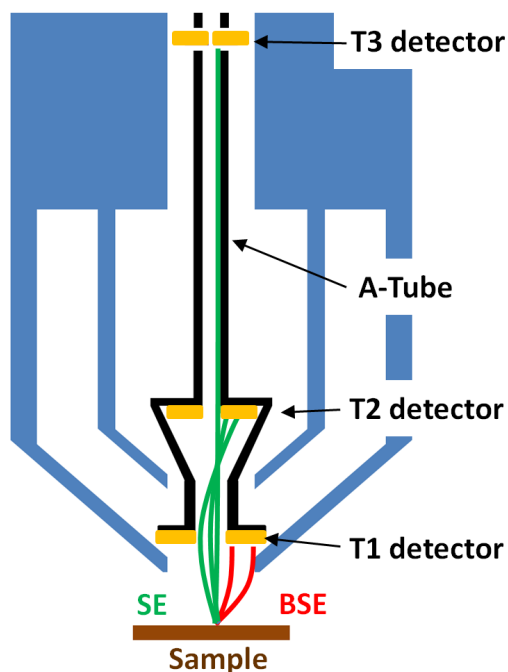
Probe currents above 13 nA are available for analytical applications such as EDS, WDS or EBSD. It should be used when higher probe currents are required. Currents can be as high as 400 nA; the accelerating voltages above 13 nA are available within 5 to 30 kV. The A-Tube is on the ground potential, the ETD detector should be used for secondary electrons and T1 or DBS (optional) for backscattered electron imaging.

- **OptiPlan**

Here primary electrons are accelerated by the potential of the Acceleration tube (A-Tube) and pass through the column at high energy. They are decelerated back in between the T1 detector and the sample. Secondary as well as backscattered electrons are also collimated into the final lens by the A-Tube electrostatic field and detected by the Trinity detectors (T1, T2, T3).

This mode is used for ultrahigh resolution electron imaging of the sample at short working distances (1 – 2 mm). The A-tube is at the highest potential and the T1 and T2 detectors should be used. The full range of the Beam Deceleration mode (if installed) is available for this Use case.

In this mode, the maximal working distance depends on the landing energy (Beam Deceleration mode). It ranges linearly from 5 mm (at 200 eV) to 70 mm (> 10 keV). It is possible to use overview imaging at the maximal field of view, so there is no need to switch the Use Case for navigation purposes.



**Note**

For detailed high resolution electron imaging, see the Help menu / User Guidance item / High Resolution Imaging.

- **Immersion**

This Use case is available only with the Immersion lens (option). The primary electrons are accelerated by the potential of the A-Tube (Acceleration tube) and pass through the column at high energy. They are decelerated back in between the T1 detector and the sample. Moreover, immersion magnetic field is applied in between the pole piece and the sample to form the smallest possible beam diameter. The secondary as well as backscattered electrons are collimated into the final lens and detected by the Trinity detectors (T1, T2, T3). Described combination of the electro-static and magnetic lenses is called Compound lens (see Chapter 3 - Compound Lens Filter module).

The Immersion Use case should be used to reach the ultimate performance – the best resolution. The optimal working distance for ultra-high resolution imaging is suggested to the user by the Working distance indicator, typically the lower the landing energy the shorter the optimal working distance. The maximal working distance depends on the landing energy. It ranges linearly from 5 mm (at 200 eV) to 70 mm (> 10 keV). The maximal field of view is working distance dependent and it ranges from one hundred micrometers to three millimeters.

### Model difference

The low Vac mode can be used only with *OptiPlan* and *Standard* Use cases depending on the PLA (pressure limiting aperture) installed on the pole piece.



## Standard Detectors

The *Detectors* menu and *Detector Settings* module / *Detector* list box show all installed detectors; the selected one has a tick mark next to its label. When a *Detector Settings* module / *Mode* is selected, its acronym is shown beside the detector label in the *Detectors* menu. The availability of detectors (full color label) depends on the actual conditions.

Detector selection is related to the display and to the selected beam - the system always reverts to the last detector used for that beam in that display and remembers its Contrast & Brightness settings.

Detector exchange and modification of its conditions made via the *Detector Settings* module are immediate.

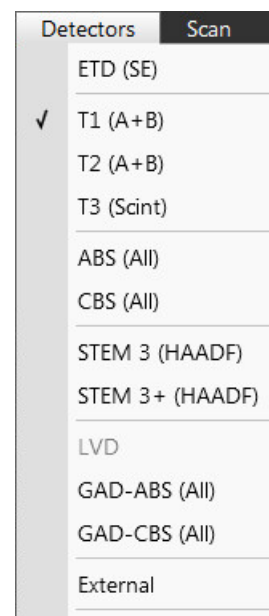
During the patterning (option) process the *Detector Menu* is still in use, but modifications will not become active until Patterning has stopped or has been interrupted. A typical circumstance under which changes can be made during a patterning session is Snapshot or image acquiring. These facilities can be set up in advance. When patterning is stopped, the last scan detector and scan conditions will be set.

**Note**

*If a detector that is not compatible with the actual vacuum mode is selected, imaging cannot be started.*

*Images from individual segments / detectors can be acquired simultaneously in up to four different displays.*

In addition to the standard detectors available, there may be optional ones available for your system (see Chapters 2 and 7).



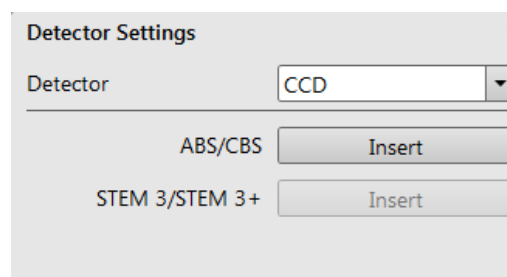
## Retractable Detectors Control

When any retractable optional detector is installed in the system, the appropriate *Insert / Retract* button is added to the *Detector Settings* module / *Detector CCD* to enable control of the equipment while observing the optical imaging display. The same button is also present in the appropriate detector module.

To insert any retractable detector, a confirmation dialog appears. When insertion is not possible, tooltip gives a reason why.

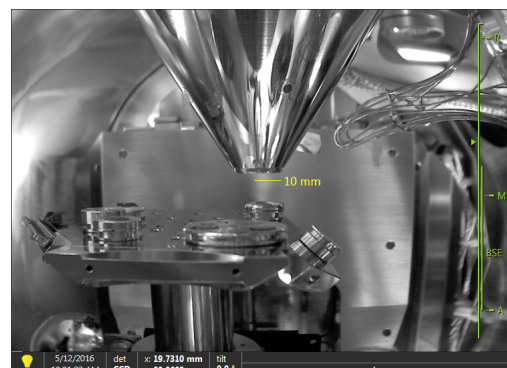
Detector insertion not allowed:  
Please link Z to FWD

Detector insertion not allowed:  
Please calibrate the rotation axis first



## Infrared CCD Camera

Imaging obtained with this camera assists in overall sample and stage orientation by viewing the inner space of the specimen chamber (an optical imaging display). It helps protect the objective lens and retractable detectors against collision when moving (especially in the Z-direction) or tilting the stage. IR LED's are used to light the specimen chamber's interior.



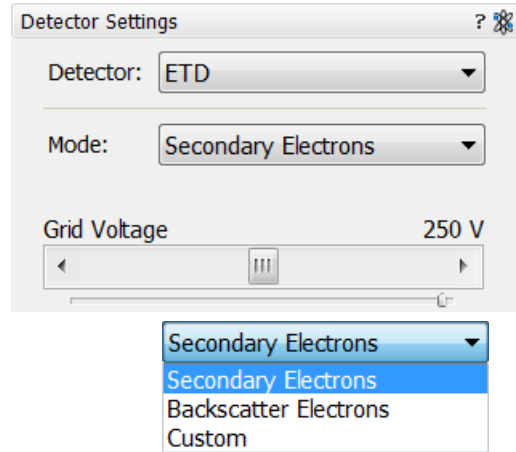
## Everhart Thornley Detector (ETD)

The Everhart Thornley Detector is a scintillator photo-multiplier type detector that collects electrons generated by the primary beam interaction with the specimen surface. It is permanently mounted in the chamber over and to one side of the sample. It works in *Modes*:

- Secondary Electrons (SE)
- Backscattered Electrons (BSE)
- Custom

### ETD Settings

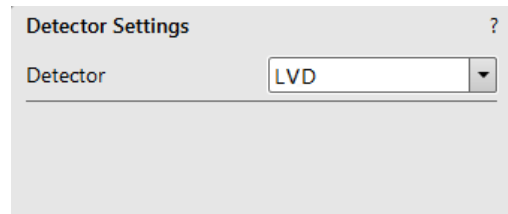
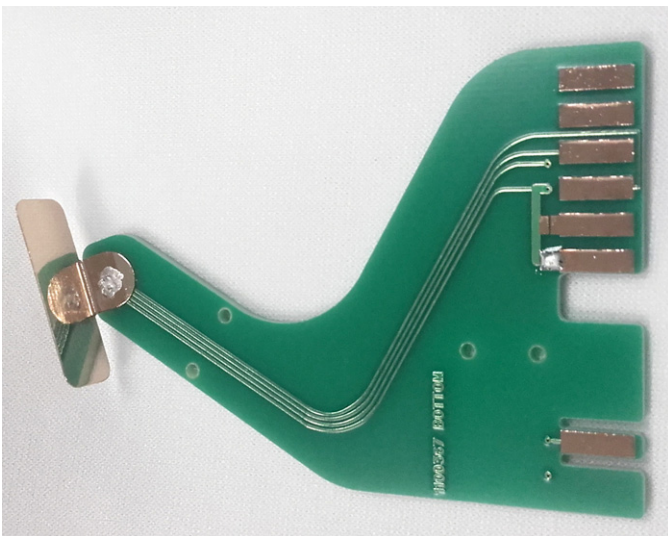
The *Detector Settings / Mode* list box enables choosing an *SE / BSE* mode (the *Grid Voltage* is set to +250 V / -150 V) or a *Custom* mode, for which the *Grid Voltage* can be set by the adjuster in a range from -240 to +260 V. When the voltage is negative (use a range of -25 to -240 V), SE are repelled from the ETD detector and only BSE are detected.



## Low Vacuum Detector (LVD)

This detector is standard and optimal for general imaging in Low Vacuum mode over the entire pressure range from 10 - 500 Pa (0.08 to 4 Torr). Its signal contains both secondary and backscattered electrons. The LVD detector limits the field of view to about 1 mm at the 10 mm working distance. The minimum working distance is limited to about 3 mm.

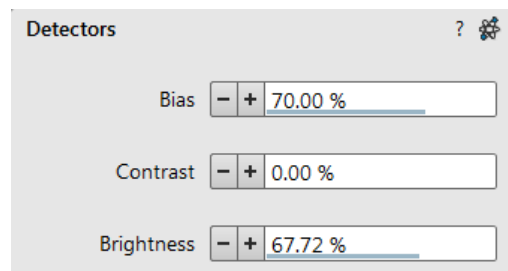
FIGURE 5-7: Low Vacuum Detector (LVD)



### LVD Settings

After the pump down and purge processes, switch on the accelerating voltage. The modified Detectors module / Bias slider is automatically activated.

Adjust Bias if necessary to increase the signal or to stop possible discharges. At the lowest possible magnification, adjust the Contrast and Brightness, if necessary, until the bright circle of the LVD cone can be seen in the center of the image. Increase magnification and adjust Contrast and Brightness more precisely.



## Trinity Detectors T1 / T2

Electrons generated by a primary beam can be collected by the in-lens Trinity detectors T1 and T2, which are located inside the final lens.

### Note

Whenever the T1 or T2 is selected, the optical display is paused (the CCD camera infra-red LED's are switched off to keep emitted photons from supersaturating the detector).

## T1

The T1 detector is primarily designed to collect backscattered electrons. It provides composite sample contrast. In the OptiPlan and Immersion column Use cases, it detects backscattered electrons throughout the whole range of accelerating voltages thanks to the A-Tube at high potential that accelerates the BSE towards the detector. In the Standard column Use case, the T1 provides strong BSE contrast at accelerating voltages of 5 kV and higher.

The Compound Lens Filter is optimized for this detector especially.

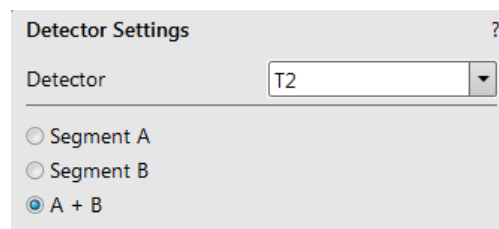
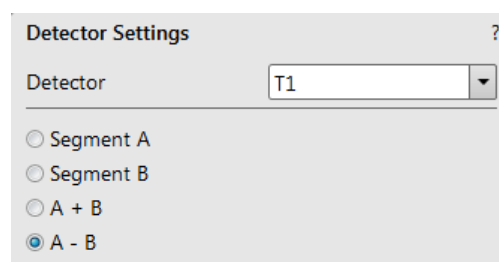
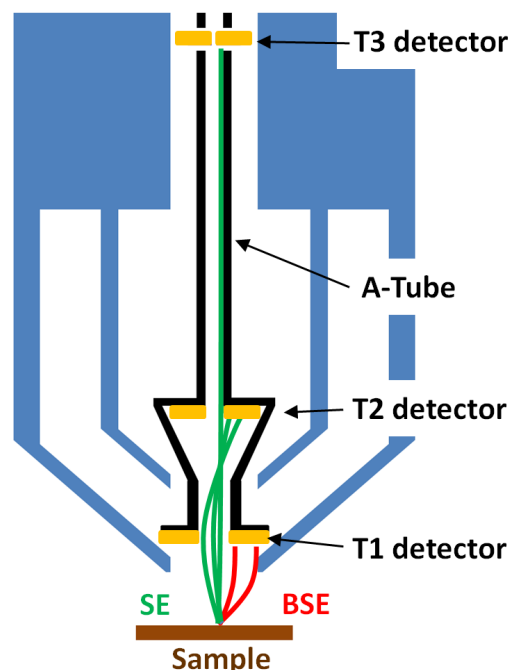
The functional detector area is split into two halves, and the detector can be operated in four modes. Apart from the composite mode *A + B*, the detector can be operated in the topographical mode *A - B*, where a pseudo-topographical imaging with suppressed atomic number contrast and maximum topographical contrast is obtained. Signals from each half can be also collected separately in modes *Segment A* / *Segment B*.

## T2

The T2 detector is primarily designed to collect secondary electrons and provides information of the sample topography in the OptiPlan and Immersion column Use cases. Thanks to the high potential of the A-Tube, the SE are accelerated and collimated to the T2 detector. It can be operated with the grounded A-tube as well - Standard column Use case. In this case, backscattered electrons are collected, but the accelerating voltage must be at least 5 kV. The intensity of the signal in the Standard column Use case is dependent on the beam current and working distance - the higher the beam current and the shorter the WD, the higher the T2 signal.

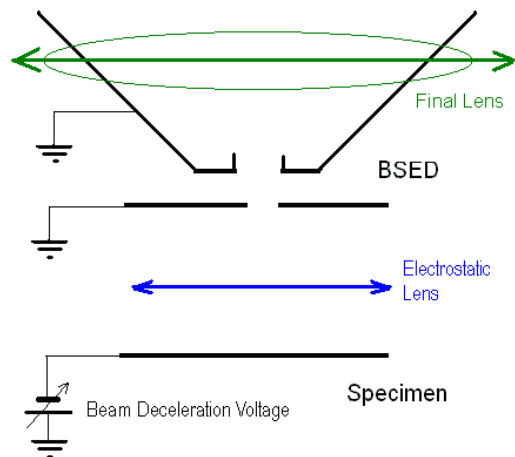
## T3 (option)

Electrons generated by a primary beam can be collected by the in-column Trinity detector T3, which is located inside the column just below the aperture strip (see Chapter 7).



# Beam Deceleration

The Beam Deceleration (BD) mode is based on a negative voltage (bias) applied to a stage (i.e. a sample). An electrical field is formed between the sample and the nearest surface over it (a column bottom or a detector). This field acts as an additional electrostatic lens. Its power is described by the Immersion Ratio (imRatio) parameter.



## Detection Principles

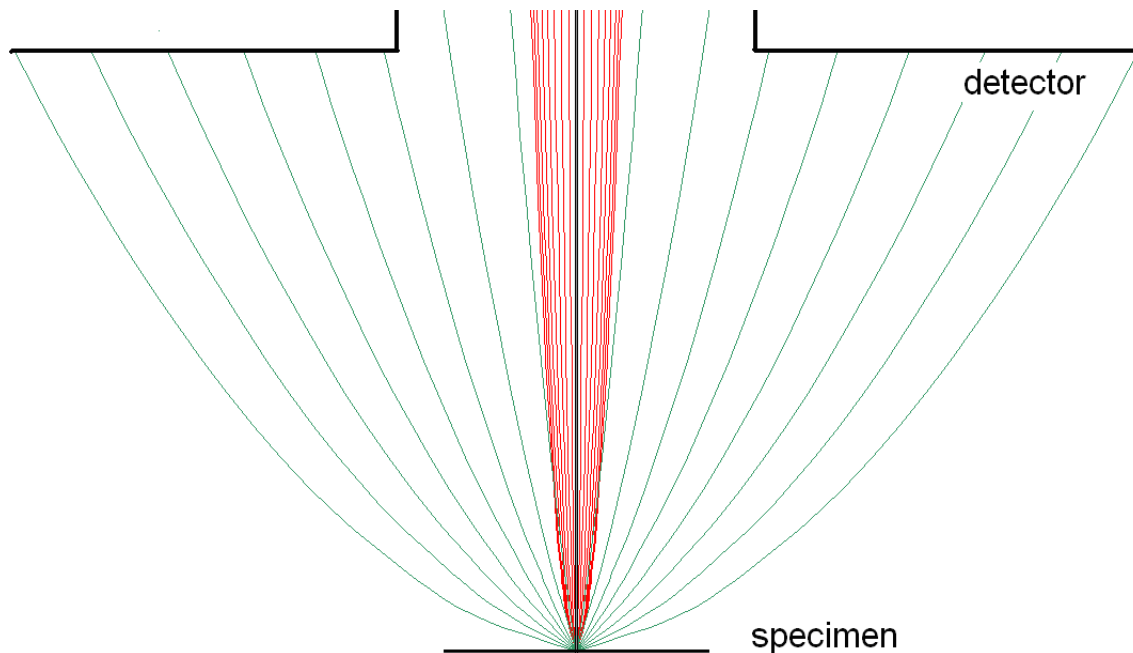
Beam Deceleration influences both primary and detected electrons.

As the sample is at a negative potential with respect to the ground and detectors, the initial SE and BSE energy (when leaving the surface) is accelerated by the Stage Bias before the detection. The higher the Immersion Ratio is, the lower the difference between SE and BSE energies is when detected.

Signal electrons are accelerated upwards and deflected towards the column axis. The SE's have a low initial speed. They are usually absorbed into the detector central hole, continue through and can be detected by in-column detectors (T2 and T3). Conversely, the BSE, heading nearly parallel to a surface (which normally cannot be detected), are driven to a detector.

By changing the Stage Bias, the output angle of electrons leaving a surface can be changed.

**FIGURE 5-8:** Typical trajectories of secondary (red) and back scattered (green) electrons

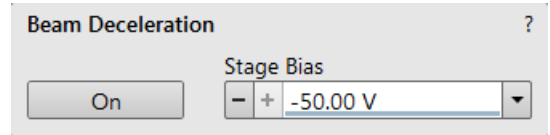


Detectors most convenient for Beam Deceleration are BSE detectors placed closely under or directly inside the column. Their efficiency depends on their active area - the smaller the inner diameter of the active area is, the better. The standard ETD can also be used, but its efficiency is low.

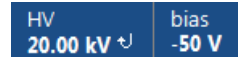
## Beam Deceleration module

The *Beam Deceleration* module has the following features:

- *On* button - switches the BD mode On / Off. This is available only in the HiVac mode and with the Beam On. When switching the beam off, the BD mode switches off automatically.
- *Stage Bias* adjuster - reflects the voltage applied to a stage up to -4 000 V.



When the BD mode is on, a hook mark is placed behind the HV. In this case, the value represents the energy of electrons reaching a sample surface (it is also stored within the TIF file header).



$$\text{imRatio} = (\text{HV} + \text{bias}) / \text{HV}$$

### Beam Deceleration Mode Imaging Procedure

1. Put the sample into the chamber and pump down to HiVac.

In the BD mode, a sample becomes the electrode. Its position, size, tilt and surface roughness influence imaging quality. At optimal conditions the sample should be symmetrical, planar, have a size comparable to the detector size, and be placed perpendicular to the column axis. Under other conditions, distortion, astigmatism and blurring caused by chromatic aberration appear. This is even worse when the Immersion Ratio is higher.

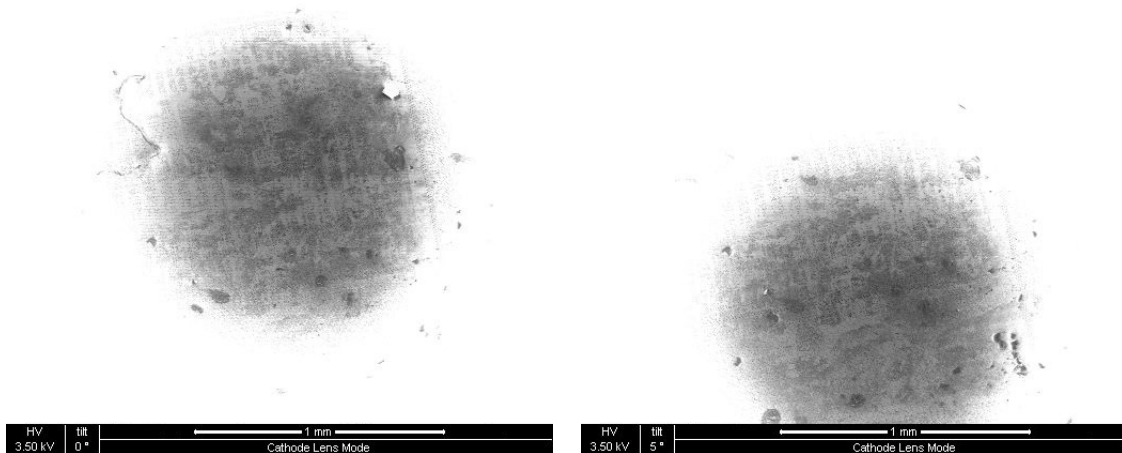
2. Select the suitable HV and find an area of interest. Set the Eucentric Position and tune an image with the *Direct Adjustments* module / *Beam* and the *Stigmator Centering tabs* (see Chapter 5). Using various displays, get the SE and BSE images so you can observe different images simultaneously.
3. Click the *On* button. Gradually raise the Stage Bias (lower voltage); the SE / BSE image gets dark / light. At low magnifications, an ETD image should become dark symmetrically around the window center. In other cases, the sample can be tilted.

When a dark area is shifted with a Stage Bias change, the sample is possibly not parallel with the detector. With the use of the Compucentric stage rotation / stage tilt, try to keep the dark area in the center of the screen.

#### Note

When a retractable detector is inserted, stage tilt is restricted via the UI. Overcome it manually (confirmation is necessary) to keep the dark area in the center of the screen.

An image shift when changing the Stage Bias can be caused by imaging near the sample edge or any other edge.



4. Set the Stage Bias, considering the sample material (charging compensation, material contrast) and optimizing the signal. Set the brightness, contrast and WD as required.
5. Tune the *Direct Adjustments* module / *Beam* and the *Stigmator Centering tabs* (both factors remember the HV and Stage Bias last used).
6. Repeat steps 4 and 5 to get the best results.

#### Note

For the column Use case application suitable for the Beam Deceleration mode, see the Help menu / User Guidance item.

## Applications

The Beam Deceleration mode provides the following features:

- Enables detection of the BSE when the electron energy is under the detection limit of the detector.
- Expands the electron energy range under the minimum HV limit.
- Improves the microscope resolution at low accelerating voltages. A conventional microscope resolution is limited by chromatic aberrations at low electron energies. The higher the Immersion Ratio, the smaller are the aberrations and a loss of resolution at low electron energies is well compensated.
- Enables detecting of electrons heading nearly parallel to a surface, which accentuates surface roughness.

## Restrictions

In the LoVac mode, the chamber environment is rather electrically conductive, and the BDM is not available.

### Sample preparation and limitations

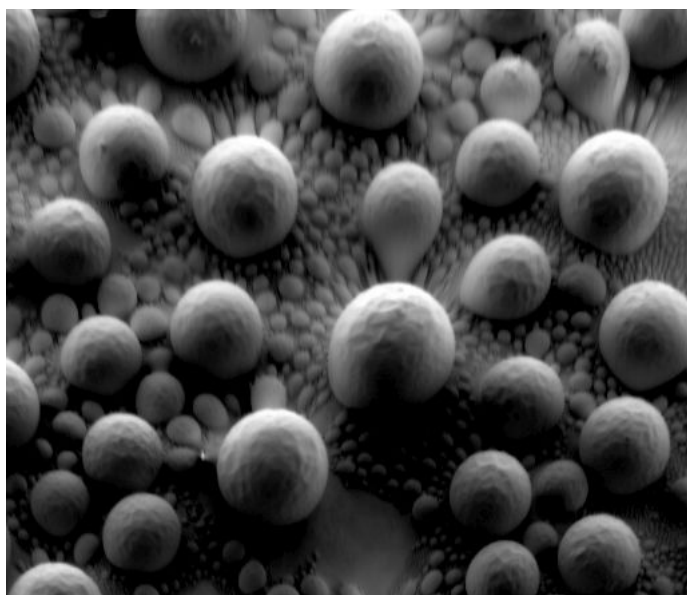
In general, all types of samples can be imaged using the Beam Deceleration mode. However, there are several types with certain limitations that should be mentioned:

#### ▪ Tilted samples

Tilted samples, such as non-horizontal fractures, may cause distortion of the electrical field deformation, which adds non correctable aberrations and an image distortion. In general, the flatter the sample the better for the resolution and also ease of use (fewer corrections of astigmatism and lens alignments).

An acceptable sample tilt is about a few degrees; for higher immersion ratios, it is preferably less.

**FIGURE 5-9:** *Signal Distortion and Image Aberrations for Tilted and Rough Sample (Tin balls) at high Immersion Ratio*



#### ▪ Particulate samples

All samples consisting of small (micro- or nano-particles) particles must be prepared to minimize presence of volatile particles on the stub when loaded into the chamber. The sample can be prepared either from solution (dilute the powder in ethanol or isopropylalcohol, disperse and put few droplets on a clean stub or piece of wafer) or fixed by carbon paste or tape. When pumping and venting, keep the sample at long working distance (10 mm) and ideally off the pole piece. Imaging can be done on any working distance.

For the systems with T1 detector, the shortest working distances are interlocked by the software.

#### ▪ Non-conductive particles, fibers, wires and rods

These samples are very sensitive to charging induced by an electron beam. When charged, they have tendency to be attracted by the electric field of the Beam Deceleration, and move around the stub or travel towards the final lens pole piece. Therefore, these samples have to be securely fixed to the stub. Longer working distance or lower Stage bias is another way that prevents the column from the particle contamination. Decreasing of a sample exposition to the electron beam (by setting of low voltage, low current and short dwell time) is recommended.

## Caution!

*Always use a dust off, compressed air or nitrogen to blow all loose particles from the stub / sample before inserting into the microscope chamber!*

# Stage Control

## Eucentric Position

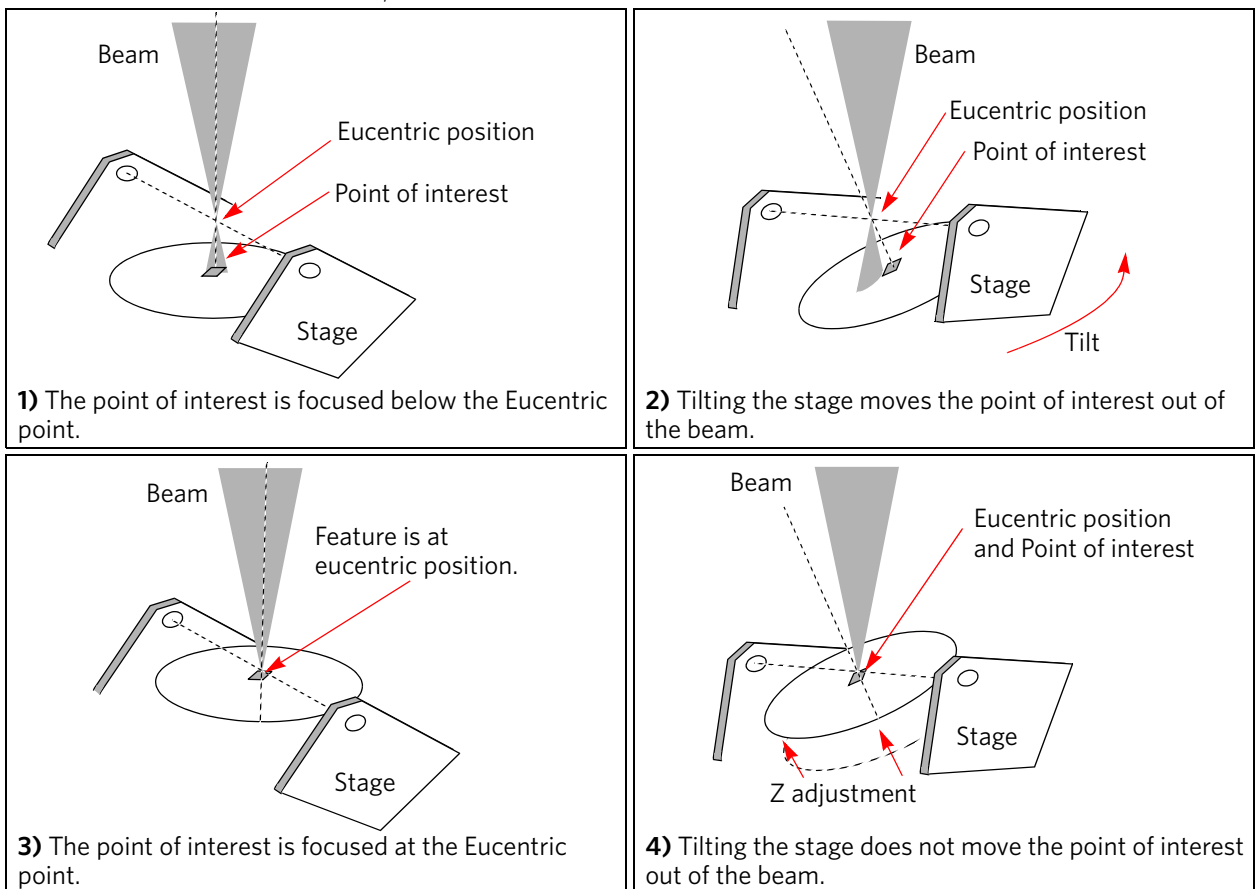
Establishing the eucentric position is an important part of setting up a sample for observation or modification. At the eucentric position, the stage tilt and the beam axes intersect. When the stage is tilted or rotated in any direction, this point remains focused and almost does not shift. At the eucentric position, one can use various system components in a safe and optimal way (e.g. GIS).

The eucentric position should be adjusted after loading any new sample, as the sample loading clears all position information.

**Note**

*For electron imaging of a non-tilted sample, the eucentric position adjustment is not necessary. But it is still necessary to run the Link Z to FWD procedure.*

**FIGURE 5-10:** Eucentric Position Principle





## Sample Top Surface Positioning

The distance between the observed sample and the stage rotation head surfaces must be properly set to bring the stage to the eucentric position. This procedure also prevents the specimen from touching the final lens when moving the stage in the Z-axis direction.

With the standard specimen holder, it is possible to move the sample (its top surface) up / down along the Z-axis if required (holder movement). This allows the flexibility of loading large height specimens onto the stage.

1. Load a specimen onto the specimen holder.
2. Adjust the Z so that the highest specimen point is approximately 7 mm below the lens by using the optical display.
3. Close the chamber and pump it down.
4. Switch on the beam, focus the specimen top surface and run the Link Z to FWD function.  
The FWD is now recognized by the system as the *Stage* module Z value.



The Z coordinate can now be changed via the software Z control around the eucentric position and further, but not less than 1 mm from the lens for safety reasons.

## Eucentric Position Setting Procedure

1. Apply the *Stage* menu / *Auto Beam Shift Zero* function.
2. Show the *Window* menu / *Center Cross* (Shift + F5).
3. Focus an image. *Link Z to FWD* and go to 7 mm WD.
4. Set stage tilt to 0°.
5. Using the Z-control, coarsely focus the image.
6. Set the magnification to 1 000×, find a recognizable feature, and center it under the yellow cross by moving the stage.
7. Watching the feature, change the stage tilt to 10°. Using the Z-control, bring the feature back under the cross.
8. Change the stage tilt to 30°, and bring the same feature back under the cross using the Z-control.
9. Change the tilt to 0°. The feature should not shift significantly. If the shift is > 5 μm, repeat steps 6 to 9.

## Software control

The *Navigation* page contains the *Stage*, *Stage Z* and *Tilt Correction* modules, which control the stage movements that locate the position of the specimen by reference to coordinate points.

### Stage module

Three modes are possible via the list box:

- *Actual* mode (default) - shows actual position coordinates in the edit boxes.
- *Target* mode - activates when clicking on a stored position or when editing a coordinate value.
- *Relative* mode - used to move the stage by a given value and to repeat it several times if needed.

Clicking on the *Go To* button drives the stage to a new location. This only acts on just-edited coordinates (with a tick mark). Pressing the Enter key after editing any coordinate value works as clicking the *Go To* button. Double-clicking on a stored location moves the stage to the desired position immediately.

During stage motion, the *Go To* button changes to the *Stop* button, which stops the stage immediately.

#### Coordinates X, Y, Z, R, T

Edit boxes for X, Y, Z, R and T coordinates are filled with the selected or actual position values. The changed value is automatically ticked.

### Caution!



**Danger of hitting the final lens! The Link Z to FWD procedure did not pass. The red up arrow next the Z axis alerts that the positive Z-axis stage movement direction is up. It means raising a value in the Z axis edit box causes moving the stage up towards the final lens.**

After running the *Link Z to FWD* procedure the symbol and the stage movements direction change. The black down arrow next to the Z axis indicates the positive Z-axis stage movement direction is down.

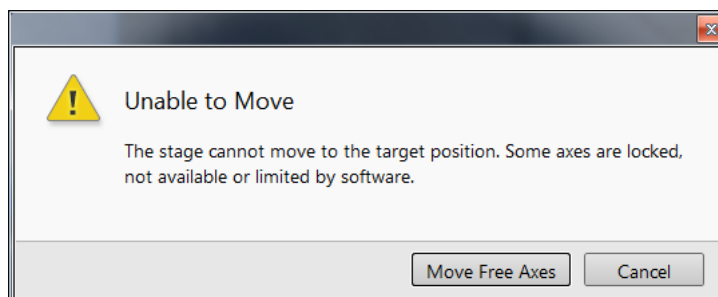
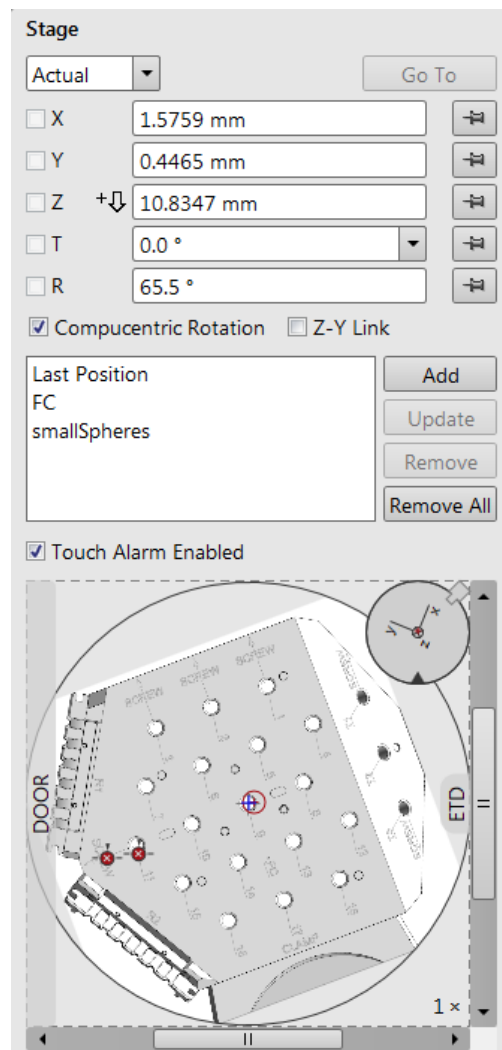


The units of measure follow the *Preferences / Units* setting, unless the *Stage* menu / *User Units* function is active, in which case UU is shown for X and Y.

The software *locks* prevent inadvertent stage movement of selected axes during particular applications. The edit boxes for locked axes are disabled and the stage does not move in these directions. When any or all axes are locked, the *Status* bar shows the closed lock icon.

When any axis is locked and stage movement is required in that direction (trying to move to the stored position), a warning dialog appears.

- When the *Compucentric Rotation* check box is ticked, the R coordinate operates as the Compucentric Rotation function (see further) and does not physical rotate the stage.
- When the *Z-Y Link* check box is ticked and the stage is tilted, the system compensates for the observed point of interest during stage movement, which allows making a Z-axis move with a tilted stage while keeping the point of interest in the field of view. This makes it much easier when imaging with the electron beam at shorter working distances to accurately switch to the eucentric position.



### Location list

This list shows stored stage positions. When expanded the scrollbar is available. The *Last Position* (the stage position before latest movement), which is updated during stage operations, is in the list by default.

The position selected becomes the actual active position and it is highlighted in the list and also in the map area (12).

Clicking on a position name allows a user to edit it. Pressing the *Enter* key or clicking on a different item confirms the new name; pressing the *Esc* key restores the old name.

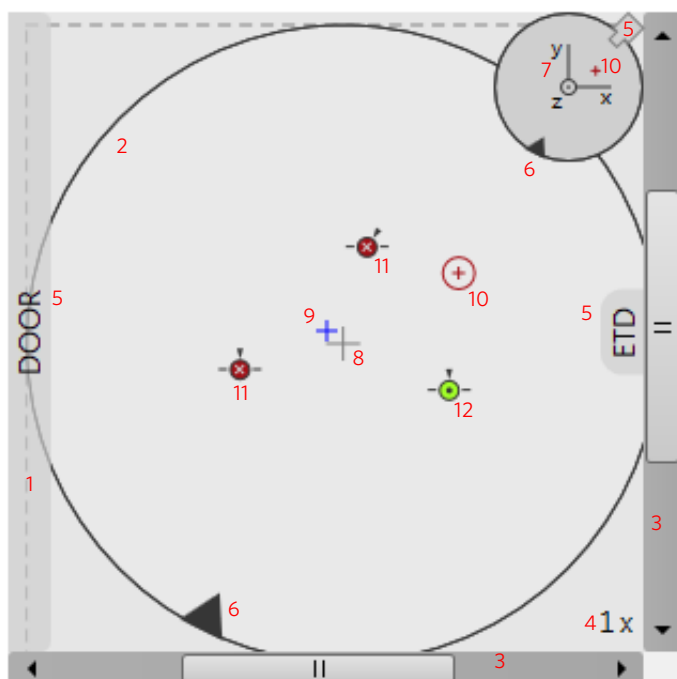
It is possible to load / save stage positions (.stg file) with the use of the *File* menu / *Import* / *Export* functions.

- When the *Touch Alarm Enabled* check box is ticked, stage movement is stopped, and the Touch Alarm warning dialog appears whenever the stage or a conductive specimen touches the objective lens or any other equipment conductively connected to the chamber. This functionality is also used when the stage engines rise their power above a determined level.






### Map area

In the map area, the stage schema is represented showing all stored positions, which are listed in the *Location* list.

**FIGURE 5-11:** Map Area Elements

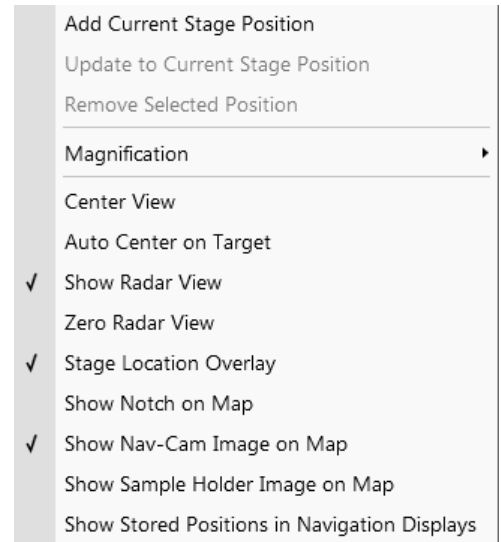


**Table 5-3:** Map Area Elements

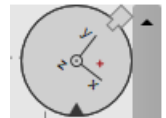
Number	Function
1.	Light gray rim (dashed line): physical limit of the stage movement along the X and Y axes
2.	Dark rim (continuous line): the sample holder outline
3.	X / Y scroll bar: to move the map area at different magnification factors
4.	Magnification factor of the map area (1× - 100×)
5.	Stage rotation overlay: Chamber door / ETD / CCD camera
6.	Notch (black triangle): rotation marking (active control within the Radar view)
7.	Radar view X / Y / Z (perpendicular lines): stage axes
8.	 Gray +: mechanical stage center: X = 0, Y = 0
9.	 Blue +: map area center
10.	 Red + in a red circle / Red + (Radar view): actual stage position
11.	 White x on a red background: a stored location (rotation noted by the black triangle)
12.	 Black • on a green background: a stored position selected (highlighted in the location list)

Double-clicking anywhere in the circle area marks a new location (10) and moves the stage to that position. Right-clicking on the Map area provides a context menu.

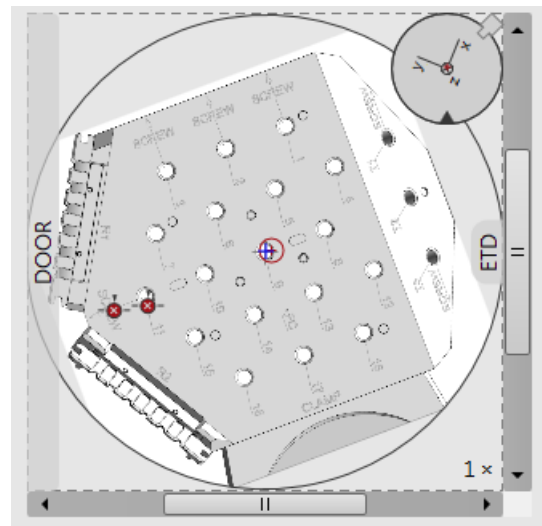
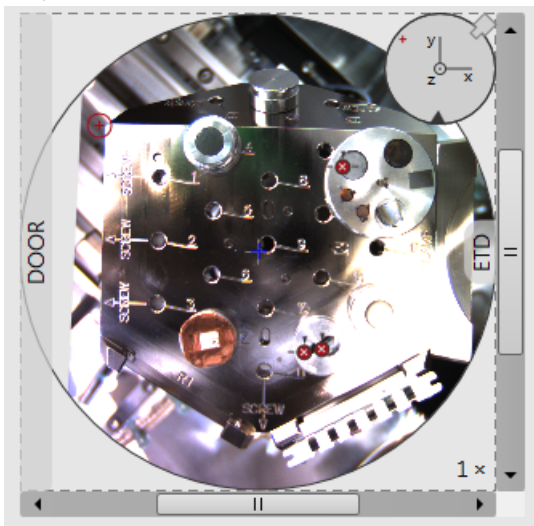
- Add Current Stage Position** – adds a new Location list entry, using the actual position. The new entry is named *Position (X)* (X = 1, 2, 3...). When renaming and the name already exists, a number increment is added after the name. The *Add* button has the same functionality.
- Update to Current Stage Position** – stores the (edited) coordinate values under the selected name (an overwriting confirmation dialog appears). The *Update* button has the same functionality.
- Remove Selected Position** – deletes the selected location(s) from the map and from the Location list. The *Remove* button has the same functionality.
- Magnification** – provides a menu allowing the *Map* area magnification factor (4 – from 1× to 100×) to be selected. Scroll bars (3) appear if necessary to move over the whole *Map* area.
- Center view** – brings the actual stage position (10) to the map area center (9).



- When the *Auto Center on Target* item is ticked**, the actual stage position (10) remains in the map area center (9).
  - Show Radar View (7)** – switches the radar view show in the map area On / Off.
  - Zero Radar View** – resets the Radar view X / Y axes rotation representation to 0°.
- The radar view conveys the stage rotation at any time either by the stage axes or by the notch.



- To rotate the stage**, click on the notch (black triangle), drag it around the radar view perimeter, and release the mouse button at the desired position – the stage rotates accordingly.
- Stage Location Overlay (5)** – toggles the representation of the detector(s), chamber door, and CCD camera in a mutual relationship.
- Show Notch on Map (6)** – switches representation of the black triangle in the map area On / Off; it gives quick information about the stage rotation.
- Show Nav-Cam Image on Map** – switches representation of the Nav-Cam image in the map area On / Off
- Show Sample Holder Image on Map** – switches the sample holder schema representation in the map area
- Show Stored Positions in Navigation Displays** – switches representation of stored positions in navigation displays On / Off.



## Stage Z module

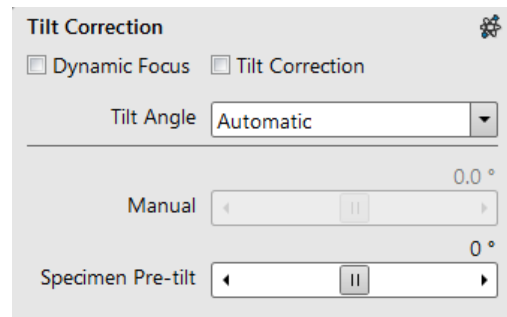
This module enables slowly moving of the stage in the Z-axis direction. The more the slider is pushed to the each side, the faster the stage motion is. Clicking on the slider bar moves the stage by a small step.



## Tilt Correction module

When the appropriate check box is ticked, the function becomes active.

- *Dynamic Focus* check box ticked - the focus automatically changes as the beam scans from the image top to its bottom, trying to follow the change in the working distance of the tilted specimen.
- *Tilt Correction* check box ticked - the flat specimen foreshortening compensation is on (in one direction, at a known tilt angle, when the tilt axis is parallel to the stage XY plane).



Because the image is a two-dimensional representation of a three-dimensional object, certain distortions occur. For instance, a square grid image appears rectangular when you tilt the specimen. This function corrects the aspect ratio and restores the square appearance.

- *Tilt Angle* list box - enables choosing among 3 modes.

In the *Automatic* mode, the *Tilt Angle* is equal to the stage tilt plus the *Specimen Pre-tilt* adjuster value (a Tilt Angle correction in case the specimen is not parallel to the stage XY plane).

In the *Automatic* mode, 90° is added to enable observing the cross section perpendicular to the sample surface.

When in the *Manual* mode, the adjuster enables manually setting of the Tilt Angle from -90° to +90°. It is useful when the *Dynamic Focus* with *Automatic Tilt Angle* does not give satisfactory results (or cannot be used at all because the specimen is tilted in a direction different from that of the stage Tilt).

When switching from *Automatic* to *Manual* mode, the actual Tilt Angle is not changed. When switching to *Automatic* mode, the Tilt Angle is set to the actual stage tilt.

### Note

*Both Dynamic Focus and Tilt Correction work properly only if the specimen (scanned area) is tilted around the X-axis (in the same direction as the stage Tilt). Therefore they cannot be used with Automatic Tilt Angle in combination with a non-zero Scan Rotation. If the specimen is tilted in a different direction, you have to align the tilt axis horizontally using the Scan Rotation, and then optimize the image focus by tuning the Manual Tilt Angle.*

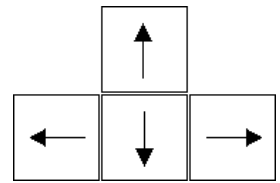
*Both functions are also disabled (check box cleared) in the Crossover mode.*

*Due to the limited range of dynamic focusing, the overall conditions should be within certain limits. If the dynamic focus is out of range, an information sign next to the check box becomes visible. Leaving the mouse over this sign calls up a tooltip giving advice with information about what must be done to enable it again (usually increase the dwell time or the resolution).*

## Stage Related Functions

### Stage Movements - Keyboard Shift

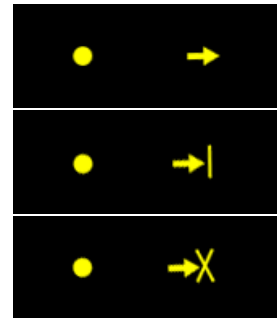
The stage can be moved by 80% / 40% of the field of view in a perpendicular direction by pressing / Shift + pressing the appropriate keyboard arrow key.



### Stage Movements - Track mode

This functionality allows continuous directional stage movements at a variable speed (see the *Preferences / General* section / *Switch sample tracking on mouse wheel click on item*):

- *Wheel-click & drag* mode - the yellow dot appears onscreen in an active display at the mouse cursor point. Move the mouse to the direction intended for an observation - a yellow arrow appears onscreen denoting the direction of the stage motion. The motion speed increases with the distance between the arrow and the dot. The direction can be changed by moving the mouse. When you come to the place of interest, release the mouse wheel - the action stops.



#### Note

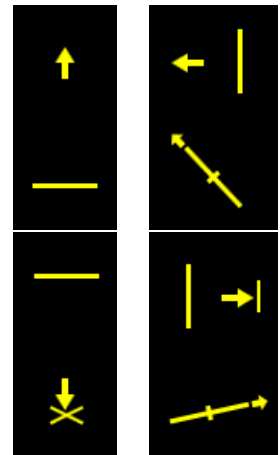
When a yellow line perpendicular to the moving direction appears, the stage approaches the movement limit in that direction; when a yellow cross appears, the limit was reached.

- *Wheel-click & move* mode - the mouse wheel does not need to be held; just click on the desired direction to start the Track motion and click again to stop it.

In the optical imaging display, clicking the mouse wheel activates the stage Z movement, which can be seen live.

- *Wheel-clicking & dragging* the mouse up / down - moves the stage up / down (Z-coordinate).
- *Ctrl + Wheel-clicking & dragging* the mouse left / right - tilts the stage left / right.

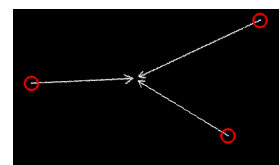
The direction is indicated by a yellow arrow, either pointing up / down from the horizontal line or left / right from the vertical line.



### Stage Movements - Get mode

This function brings an image point of interest to the screen's center.

Double-click anywhere within the imaging display; this point is mechanically centered onscreen by moving the stage, which is suitable for lower magnifications. When working at higher magnifications, beam shift can be also employed (see the *Preferences / General* section). In this case, the point is electronically centered onscreen by moving the electron beam. When the beam shift comes to a limit in any direction, its value resets, and the necessary stage movement adapts the observed point position.

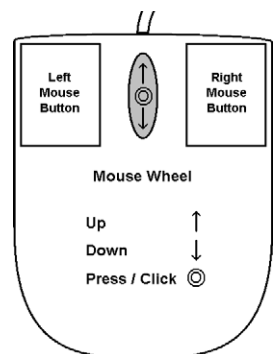


#### Beam Shift

When you want to employ the beam shift only (which is suitable for higher magnifications), shift + click on an image point. Drag the *Hand* cursor to move the imaging area in any direction.

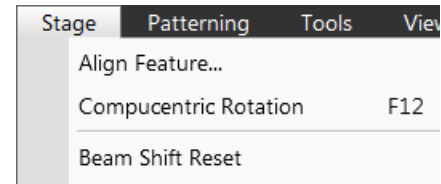
When the limit of the beam shift has been reached, either the *Stage* menu / *Auto Beam Shift Zero* or the *Beam Shift Reset* function needs to be applied. In this case, the beam shift is reset, and the observed point position is adapted by the stage movement.

Releasing the mouse button stops the action.



## Align Feature

This utility is designed specifically for long features that extend off the screen at the magnification required for an observation. It applies the mapping process by bringing the long feature either to the horizontal or vertical stage axis to make navigation easier. This can be performed at any point within the stage field limits. It takes into account the stage rotation offset.



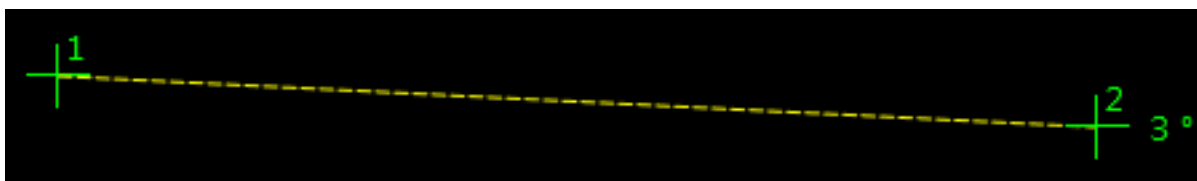
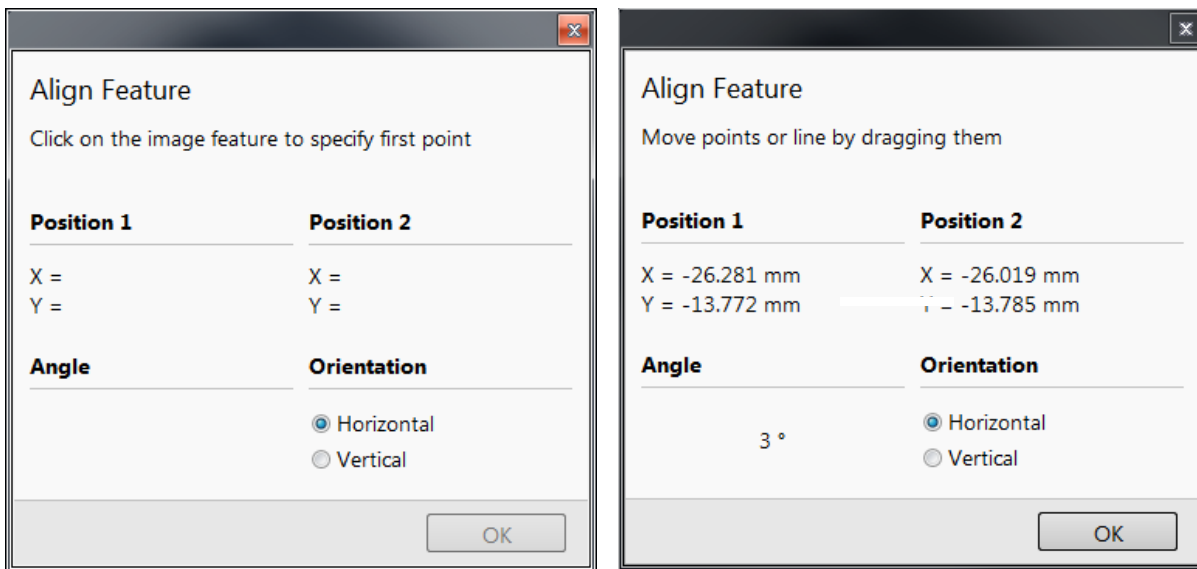
**Note**

*Align Feature works best at the eucentric position (see above). Longer distances result in greater accuracy.*

### Caution!

*Watch for obstacles extending significantly from the sample plane, as these may interfere with equipment under the lens.*

1. Find a long feature of interest on the sample.
2. Click on the Stage menu / Align Feature.
3. Choose Orientation, either Horizontal or Vertical, that relates to the desired final orientation of the feature.
4. Click on the first point along the feature. The Position 1 coordinates update.
5. Moving the mouse continuously updates Position 2 coordinates; clicking anywhere along the feature stores them. The Angle shows the value that is used to correct alignment of the feature along the horizontal / vertical axis. Right-clicking anywhere on the image area deletes points, enabling them be defined again.



6. Drag any point to change its position if needed. Click on the OK button to finish the setting.



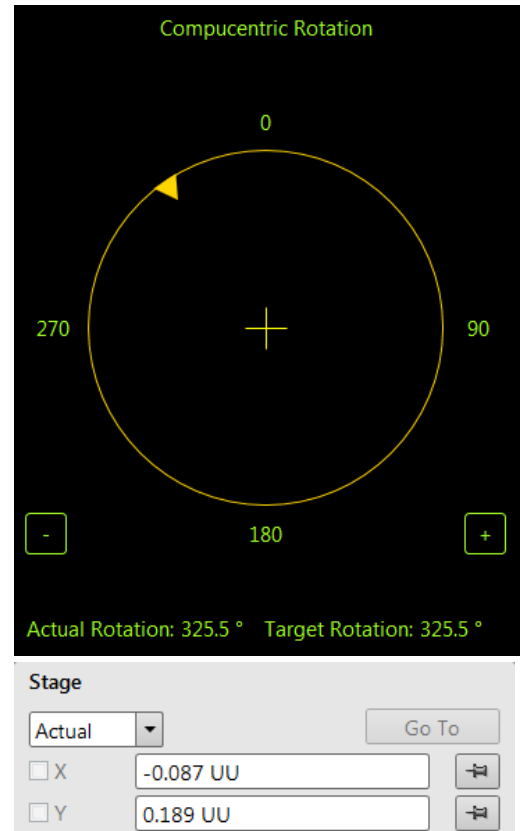
### Compucentric Rotation (F12)

Clicking on the *Stage* menu / *Compucentric Rotation* places a green circle in the image window. The green triangle on its perimeter denotes by its position the sample rotation relative to its original position when mounted on the stage. Initially, this is in the 12 o'clock position.

The readouts shown at the image window bottom provide information about the *Actual Rotation* (original position) and the *Target Rotation* (the selected position).

Click on & drag the triangle around the circle to choose a new sample rotation. Releasing the mouse updates the stage position to bring the original field of view (rotated to the Target Rotation position) onscreen. With a sample at the eucentric position this can be performed at any sample point irrespective of the mechanical stage center.

Clicking on the written angles around the circle perimeter (0° / 90° / 180° / 270°) or the perimeter anywhere drives the stage to that rotation position, and the green triangle updates onscreen. Clicking on the framed + / - sign increases / decreases the rotation angle by an incremental value.



### User Units

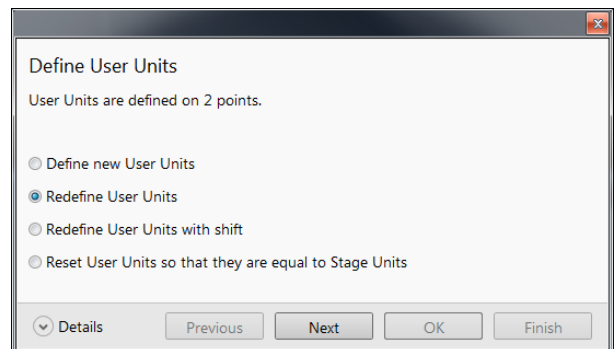
Clicking on the *Stage* menu / *User Units* item (a tick mark appears next to it) activates user defined units as the basis of the stage coordination system. The *UU* appears in the *Stage* module next to the X and Y values and the stage coordinate system activates the last defined user units.

#### Define User Units Procedure

This procedure assigns user-defined points to stage points. The stage coordination system can be anchored to either 1, 2 or 3 points, depending on the sample management or application. For example, if you choose a (0,0) position, you can drive the stage relative to that origin using user defined units (0,1 / 1,0 points), which may equal to some repeated sample structures, etc.

It is possible to end the procedure by clicking the *Finish* button when point(s) (0,0) / (1,0) / (0,1) are defined. An overview of the point(s) just defined is shown. The *Details* button shows the actual coordinates with the possibility of browsing them (*Go to* button) and editing their values.

1. Find a sample surface feature and view it at an appropriate magnification to check its relation to other structures.
2. Click on the *Stage* menu / *Define User Units* item. The dialog appears to allow choosing the desired operation:
  - *Define new User Units* – defining of new User Units
  - *Redefine User Units* – changing or updating User Units
  - *Redefine User Units with shift* – as above, with the use of the Beam Shift
  - *Reset User Units so that they are equal to the Stage Units*
3. Click on the sample user point (0,0) and its coordinates appear in the *Details* module. Proceed by clicking the *Next* button.



4. Repeat step 3 for the sample user point (1,0) and (0,1) if needed.

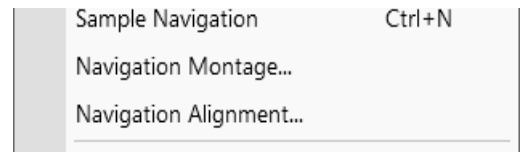
**Using 1 / 2 / 3 Point(s) Alignments**

**Table 5-4:** Alignment Type Differences

Use	1 Point Alignment	2 Points Alignment	3 Points Alignment
<b>Major Use</b>	Aligning to new point directly offset from the existing location	Aligning the stage axes with the specimen X-Y orientation to correct any distortion	Transforming to nonstandard units on dies or RAM arrays; to correct any distortion
<b>Change in Scale</b>	None	Scales the axes together	X can be scaled differently from Y
<b>Change in Orientation</b>	None	Rotates both axes with a fixed 90° angle between axes	X and Y orientation can be different

## Sample Navigation

The *Stage* menu / *Sample Navigation* (Ctrl + N) software feature enables navigating along the sample surface when the field of view is smaller than desired (limited by an aperture, for instance). For this purpose various sample navigation images can be dynamically and independently selected, regardless of their actual content and status (paused, saved, loaded).



As soon as the active display is paused, the Sample Navigation icon appears in the upper right display corner to indicate its functionality. This indicator is green, and the paused display can be used to navigate along the live one. Otherwise it turns red and indicates no functionality in the respective display.



A green rectangle showing the actually selected field of view (in the active display) appears with the size corresponding to the magnification. In display(s) using Sample Navigation, the Selected Area Zooming and the Get features can be used.

To employ the Sample Navigation there are three possible techniques to acquire (or use) a Navigation image:

- Navigation Montage
- Navigation Alignment
- Nav-Cam (option)

### Navigation Montage

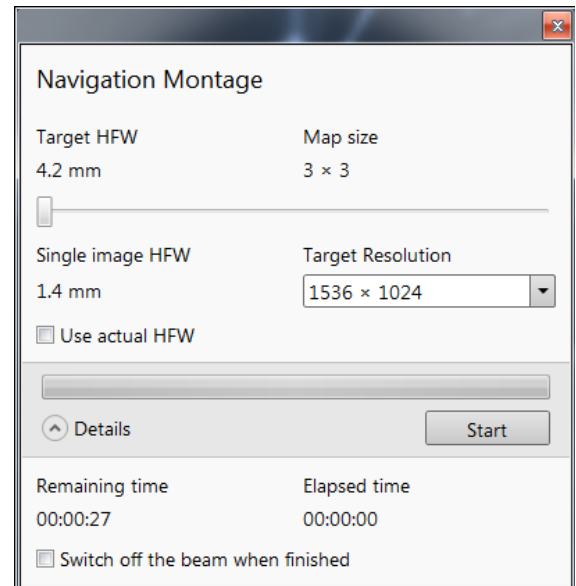
Set the *Target HFW* (Horizontal Field Width) by the slider, which influences some information field values:

- *Map Size* - the number of tiles
- *Single Image HFW* - HFW of each tile
- *Remaining / Elapsed Time* - time still needed for the procedure completion / elapsed
- *Target Resolution* - navigation image pixel resolution
- *Use actual HFW* check box - when ticked, the system does not automatically use the HFW according to the hardware configuration, and sets the user one.

This is convenient when the image corners are rounded and imaging does not cover an entire area.

- *Switch off the beam when finished* check box  
This is convenient to use in case a large *Target HFW* and long dwell times are used to capture the Navigation image, because the process can take a significant amount of time to complete.

Click the *Start* button to run the procedure. After process completion, Sample Navigation is then automatically set to on.

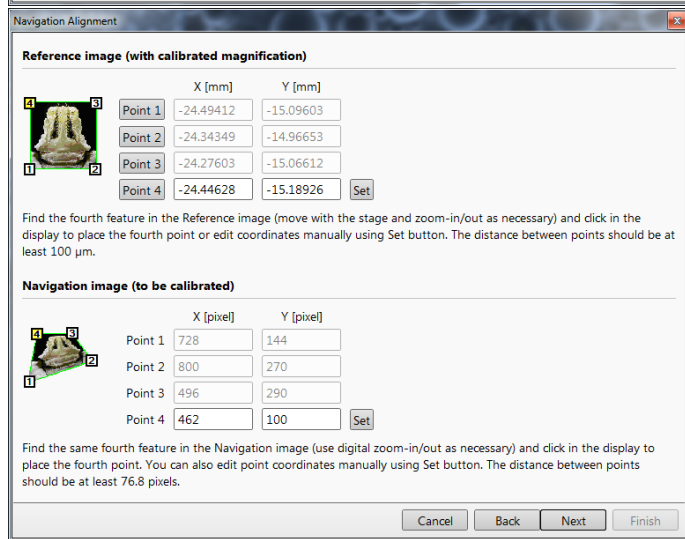
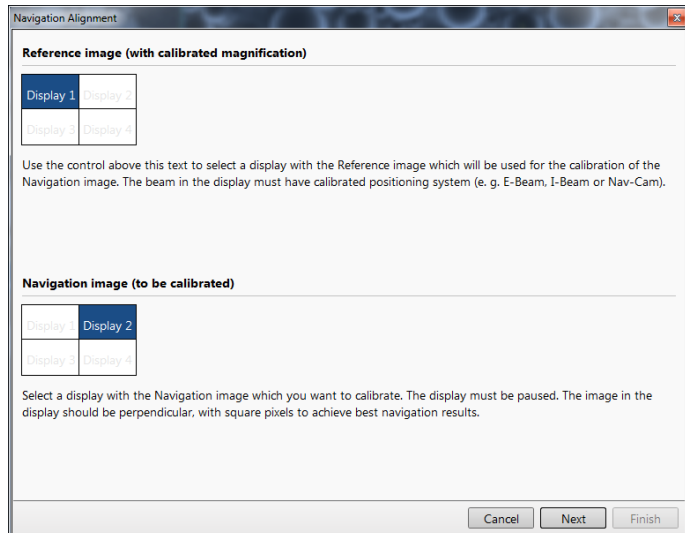
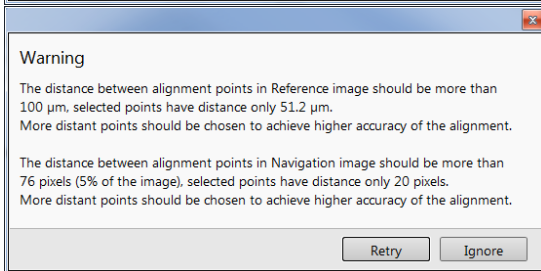
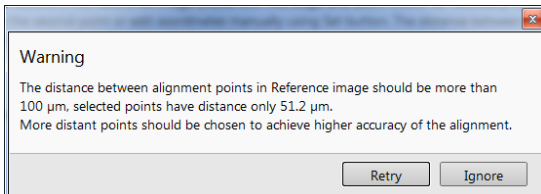


### Navigation Alignment

This procedure, in comparison to the Navigation montage or Nav-Cam (option), enables using any loaded or paused Navigation image that is calibrated according to the live Reference image.

Follow the instructions given within the process (6 dialogs) and calibrate 4 image points. If 2 points are sufficient for the desired purpose, click on the *Compute 2pt alignment* button to finish the process after setting 2 alignment points.

When any point setting does not satisfy system requirements, a Warning message informs the user.



### Scan Rotation (Shift + F12)

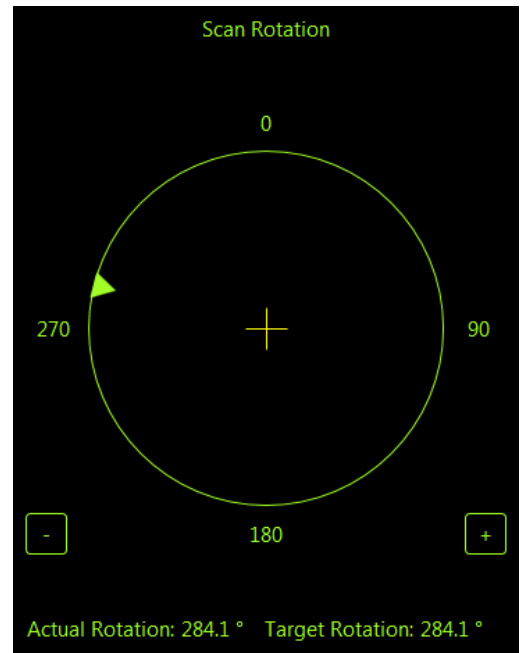
The *Scan* menu / *Scan Rotation* function activates the onscreen tool to rotate the scan and align the image. Because it is solely a functionality of the electronic optics, it has no effect on stage movements. It is used to orient the image relative to mechanical rotation and detector direction.

Clicking on the *Scan* menu / *Scan Rotation* places a green circle in the image window. The green triangle on its perimeter denotes, by its position, the sample rotation relative to its original position when mounted on the stage. Initially, this is in the 12 o'clock position. Click on & drag it around the circle perimeter to choose a new sample rotation.

The readouts shown at the image window bottom provide information about the *Actual Rotation* (original position) and the *Target Rotation* (the selected position).

Clicking on the written angles around the circle perimeter (0° / 90° / 180° / 270°) or the perimeter anywhere drives the stage to that rotation position and the green triangle updates onscreen. Clicking on the framed + / - sign increases / decreases the rotation angel by an incremental value.

	Scan Rotation	Shift+F12
⚙️	Preferences...	Ctrl+Alt+S



## Capturing and Handling Single Image

After acquiring a quality image, it can be paused (F6 or the toolbar icon) and saved (the *File* menu / *Save* item). Setup the file name label and hard drive destination for the image to be saved using the next available label / number prior to the capture session. Set the databar information important for the archiving by right-clicking on the image databar.

The conditions for good image quality are:

- Slow scan speed (longer dwell time or fast dwell time together with line or frame integration) of the beam.
- Select a pixel resolution from the drop down list box to suit the detail in the image, i.e. no tearing pixelated edges.
- Move the stage next to the area of interest, increase the magnification at least 2× above the desired value, focus, correct the astigmatism and lens alignment (using the reduced area), then return the magnification and stage position back to their desired parameters.
- Use the Videoscope to set the Contrast and Brightness accurately; otherwise use the Auto Contrast Brightness procedure.
- Use the Pause / Snapshot / Photo / Scanning preset / filtering functions.

### Image Types

A computer perceives an image as a two-dimensional array of numbers – a bitmap. Each array element is called a pixel and is represented as an integer value. Frequently, the pixel is represented as an unsigned 8-bit integer in the range [0, 255], with 0 / 255 corresponding to black / white and shades of gray distributed over the middle values. A 16-bit representation produces up to 65 536 different shades of gray (it is not possible to distinguish them onscreen), which may be crucial for obtaining accurate data in analysis.

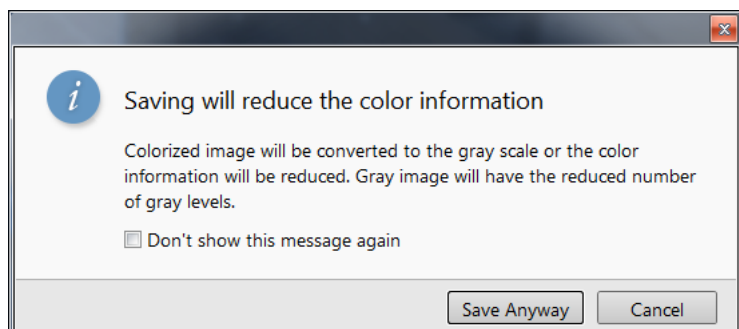
The raw scanned image is always a grayscale bitmap. Colors can be added digitally as a result of particular features. The UI is able to show and save images with various bit depths:

- *Grayscale 8 / 16 bit image* – offers 256 / 65 536 levels of gray.  
Live / Averaged and Integrated images are scanned as 8 / 16 bit ones. For the Mix display images a selection between the 8 or 16 bit mode is possible.
- *Color 24 bit image* – offers 256 levels of each primary color (red / green / blue).  
Digital colors come from the Display Saturation feature, Enhanced Image module / Color tab, and Mix display with color mode set to change image bit depth, so the image must be saved as a color one. When the user wants to acquire the image without these color enhancements, it is necessary to turn off the respective UI functions.  
An image can be saved with / without colored digital overlaid graphics (Measurements, Annotations, Patterns, Videoscope) (see the respective checkbox in the Save As dialog). Other types of overlaid graphics over an image are never saved (icons, controls, etc.).

### Digital File Formats

The image captured can be saved in various digital formats, depending on the color and bit depth needed. Generally there is no reason to save an image with a higher bit and color depth than what is available in the original image. Saving an image with a lower bit and color depth than what is available in the original leads to a loss of information. In this case, this message is shown onscreen.

- *TIF 8 / 16 file* – grayscale only image type, full data format
- *TIF 24 file* – color image type, full data format  
A file contains active processing information, which can be utilized for a databar setting.
- *JPG file* – color image type, compressed data format  
A lossy compression algorithm is used, resulting in the smaller file size with a little loss of information. The amount of loss depends on the particular image appearance and the compression level (factory preset is 80%). The 8 / 24 bit depth is automatically selected when saving a grayscale / color image file.
- *BMP file* – color image type, full data format. The 8 / 24 bit depth is automatically set when saving the grayscale / color image file.



## Saving / Opening / Printing

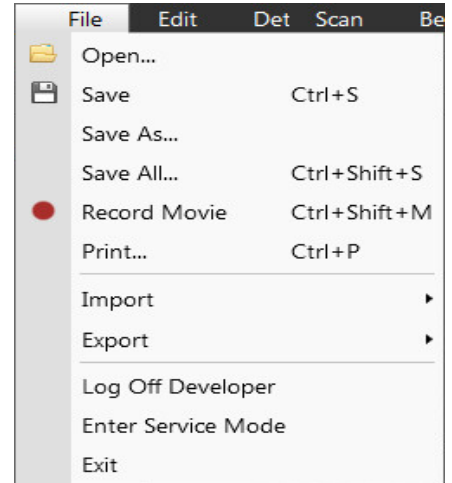
The following universal file handling functions can be used:

### Image Capturing

1. Select the area of interest and set the *Magnification*, *Scan condition*, image pixel *Resolution* and the Databar information that are required in the saved image.
2. Make the best image using any suitable method you are familiar with.
3. Use the *Pause* (F6) / *Snapshot* (F4) / *Photo* (F2) / *Active Preset Snapshot* (Ctrl + F2) / *Scanning Preset* function. The scan makes one display pass (or several passes when the number of integrated frames is larger) and pauses.

#### Note

When applying the Shift key together with above mentioned acquisition functions, the effect simultaneously works in all displays with the same beam.

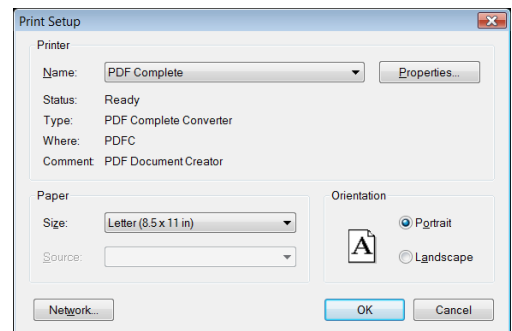


### Image Saving

- *Save* (Ctrl + S): stores the image to the predetermined location with the last used filename, including an incremental number.
- *Save As*: opens a dialog for saving images (this provides an opportunity to change the file name, its location, and the possibility to also save Databar and overlaid graphics). Both functions can be linked to the Snapshot / Photo function (see the *Preferences / Scanning* section).
- *Save All*: (Ctrl + Shift + S) behaves the same way as the Save As functionality, but enables saving the images from all four displays at once.
- *Open*: opens a single image file into the active display. The dialog shows, by default, the location used in the last Save As utilization.

### Image Printing

1. Capture the image or open a saved one.
2. Click on the *File* menu / *Print* (Ctrl + P), the printer setup dialog appears. The choice of printer and settings can be established to print the active display.
3. Complete the print setup and click the *OK* button to activate the printer and print an image.





## Recording Movies (Saving Multiple Images)

This function captures dynamic experiments performed with the microscope and creates the digital video files (AVI). Up to 4 imaging displays (not the optical one) can be recorded simultaneously with a synchronized start. It is possible to switch between single and quad image mode while the video is recording. The movie has the following embedded features:

- Resolution 768 × 512 or 1536 × 1024 (512 × 442 or 1024 × 884 for the 4:3 view)
- Databar image optionally included in the video
- Average or Integration are changeable during recording
- Scan speed is changeable during recording
- Reduced area pauses recording of all displays
- Remaining time indicator
- Single frame TIF images are recordable during the video sequence
- Compressed AVI (\*.avi) formats
- Start, Stop and Pause onscreen indicators
- Preferences set-up dialog

### Note

For the display(s) with the Enhanced Image module / Color tab / Enable check box ticked, if Movie recording is paused, the colored TIF files are stored anyway if selected.

## Movie Settings Dialog

The *Preferences / Movie* provides selections to set-up conditions for timing and save conditions for the resultant movie.

FIGURE 5-12: *Movie Preferences*

**Movie Settings**

**Movie**

**Movie Timer**

Save AVI Movie      Period: 50 ms (20 stills/s)

Save TIF images      Period: 2 s (1 TIF/ 40 movie stills)

**File Settings**

File Name: Movie

Save in: C:\temp\

File Type: AVI video compress RLE (\*.avi)

Numeric Seed: 2

Video File Size: 200 MB

Record Databar

OK    Apply    Cancel

### Movie Timer

The parameters in this section can be changed when the digital video is inactive, but are disabled during recording. The digital video is recorded asynchronously to the scanning.

- Save AVI Movie check box - Period list box:**  
 After the *Period* time, the image of each active display is stored immediately (even in the middle of the frame) as a new frame in the video stream.
- Save TIF Images check box - Period list box:**  
 After the *Period* time, series of each active display images are stored at the end of the running scan in TIF format.

If both TIF and Movie check boxes are ticked, AVI and also TIF files are stored. In this case, the AVI file is not reconstructed from TIF files, which means the directly recorded movie could be different from the movie reconstructed from TIF files.

**Note**

*In many cases it is better to save TIF files, as they can be built into a faster AVI and the databar display can be customized when building an AVI file.*

*If both AVI and TIF are recorded, the AVI may be jerky due to delays when writing TIF files to a disk. TIF delay must always be equal to or longer than the Movie delay.*

500 ms	10 s
25 ms	Every Frame
50 ms	0.1 s
100 ms	0.2 s
200 ms	0.5 s
500 ms	1 s
1 s	2 s
2 s	5 s
5 s	10 s
10 s	20 s
20 s	60 s
60 s	300 s
	600 s

### File Settings

Names of Movie [TIF] files are composed as follows:

*File name, (display name), Numeric seed, [- series number].avi [tif]*

For example: *MovieName (Channel1) 015 [- 00023]. avi [tif]*

[The series number always has a five digits form with leading zeros.]

- File Name** - enter a generic file name here. Do not use punctuation, dashes or other non alpha-numeric characters, otherwise the movie maker would not be able to build an AVI.
- Save in** - enter a path to an existing folder here. Use the *Browse* button to find the location.
- File Type** - the list box with supported video compression format types. Try to change the format if the resulting movie files are too big or if the system is overloaded during movie recording.
- Numeric Seed** - enter any number from 1 to 999, which is converted to the three digit form with leading zeros. The numeric seed is automatically incremented after the recording has stopped or the video file size limit has been reached.
- Video File Size** - the maximum AVI video file size (lower than 2 000) in MB must be entered here, otherwise the Movie section cannot be closed. After reaching this size, the video file is closed and a new one is automatically created without interruption of the recording process. A warning dialog appears if the hard drive lacks sufficient free space.
- Record Databar** check box - allows the databar to be included in the video (tif files).

## Movie Procedure

The *File* menu / *Record Movie* item (Ctrl + Shift + M) starts / stops recording of all active displays at the same time - no video / images are stored for paused imaging. When an image in any display is paused during video recording, storing video frames is interrupted, but the video streams keep synchronization for the next recording. The *File* menu / *red dot* icon changes to a *red square* when movie recording starts and vice versa. Video recording is stopped in all displays and all video files are closed.

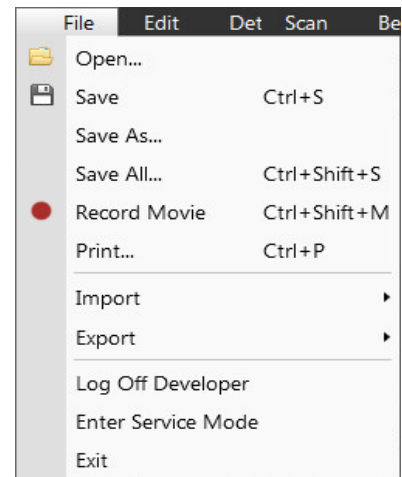
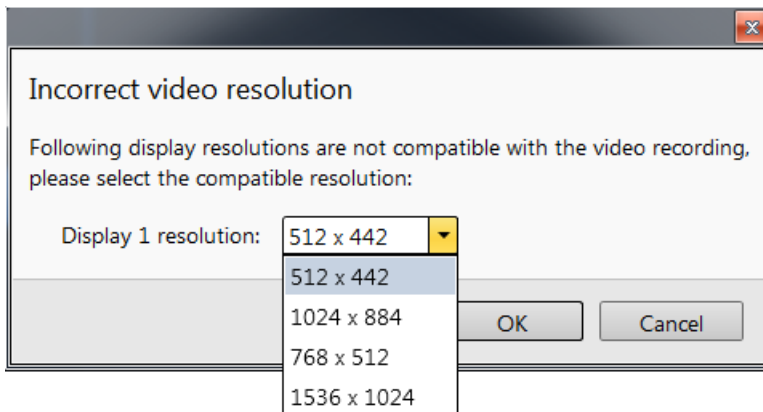


The red dot with the timer (shown in the top right-hand corner) indicates that recording is running in this display. The Pause symbol indicates that the recording is paused and the data from this display are not stored.



The timer indicates the time estimation (in the hh:mm:ss format) remaining to the end of the video. This is calculated from the average disk space consumption and disk free space.

1. Open the *Preferences* / *Movie* section. In the *Movie Timer* module, tick the *Save AVI Movie* and/or *Save TIF Images* check boxes and select the desired *Period* (time between stored frames).
2. In the *File Settings* module, fill in the *File Name* and give the *Save in* folder path. Fill in the *Numeric Seed* value and the *Video File Size*. Select the *File Type* and choose whether to record the databar with the *Record Databar* check box.
3. Pause those images that you don't want to record. Set up the imaging parameters.
4. Select the *File* menu / *Record Movie*, or press the keyboard key combination Ctrl + Shift + M, to start movie recording. When the scan resolution is higher than 1536 × 1024, the following dialog appears.



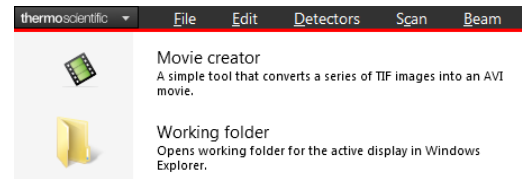
5. Choose either of the offered *Resolution* values, at which the movie starts to record.
6. Select the *File* menu / *Record Movie* again, or press the keyboard key combination Ctrl + Shift + M, to stop the movie recording.

## Movie Creator

This is a separate program that creates a single AVI movie file from a sequence of TIF images. Click on the *Thermo Scientific* menu / *Movie Creator* to activate the tabbed dialogs.

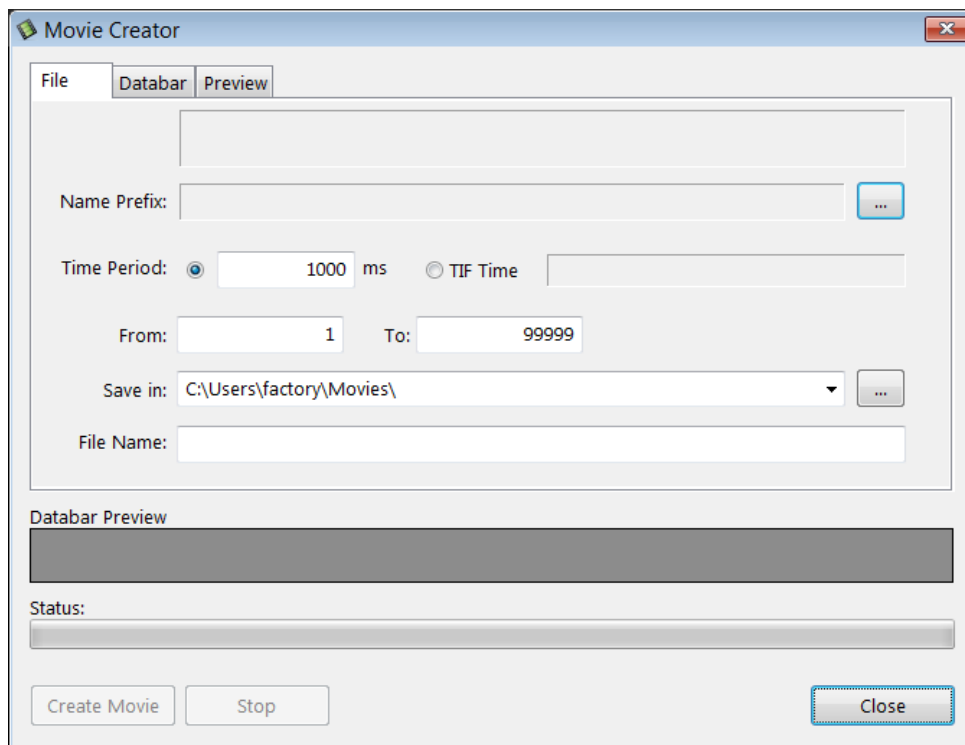
The following items are common for all tabs:

- *Databar Preview* - shows the databar created within the Databar tab.
- *Status* - shows the progress of the movie creation process.
- *Create Movie* button - opens the *Movie Creator* dialog.
- *Stop* button - stops the movie creation process.
- *Close* button - closes the *Movie Creator* program.



### File Tab

FIGURE 5-13: *Movie Creator* dialog / *File* tab



- *Name Prefix* - click on the ... button to browse the TIF files (with the desired sequence prefix) folder. It is not necessary to choose the first file in a row.
- *Time Period* - click the [ms] radio button to select a custom timing for the movie playback. One may experiment for instance: 200 ms/per image (good for most movies to speed it up) for 100 images results in 20 second total movie duration.
- *Time Period* - click the *TIF Time* radio button to select a timing for the movie playback.
- *From / To* - enter the number of the starting / ending frame. This field is filled automatically with the first / last frame available.
- *Save in* - enter the path where the AVI file should be saved. Click on the ... button to browse it.
- *File Name* - enter the resulting AVI file name. This field is filled automatically with the first image file name.

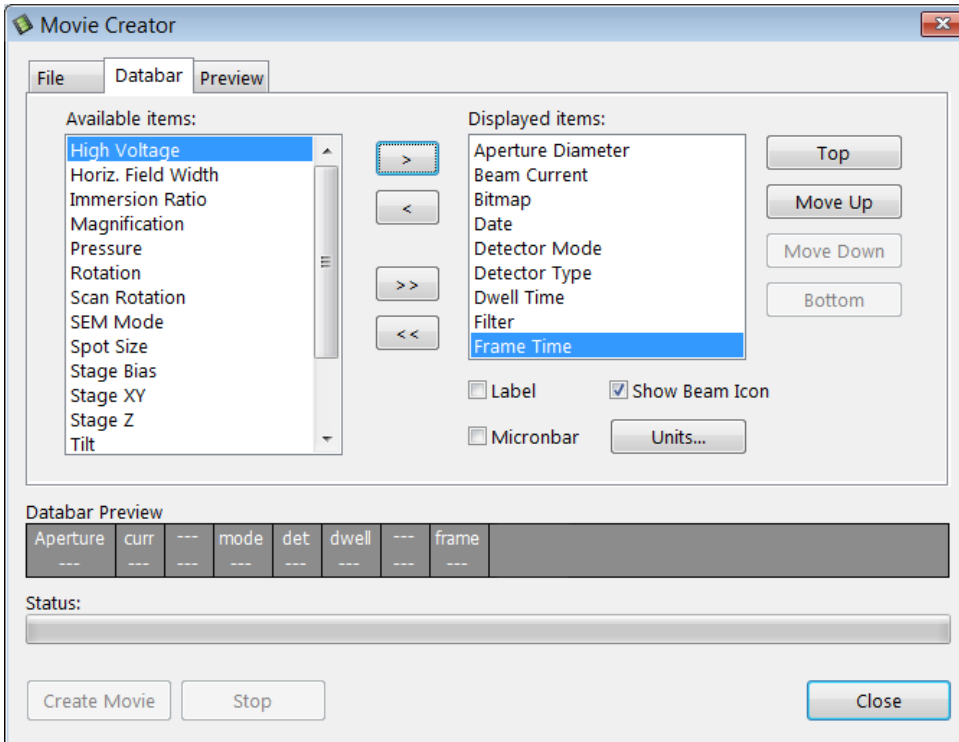
## Databar Tab

Settings made in this dialog does not affect the databar or units settings used in the UI.

### Note

The Databar Preview does not show any item until you enter the File tab / Name Prefix field.

**FIGURE 5-14:** Movie Creator dialog / Databar tab

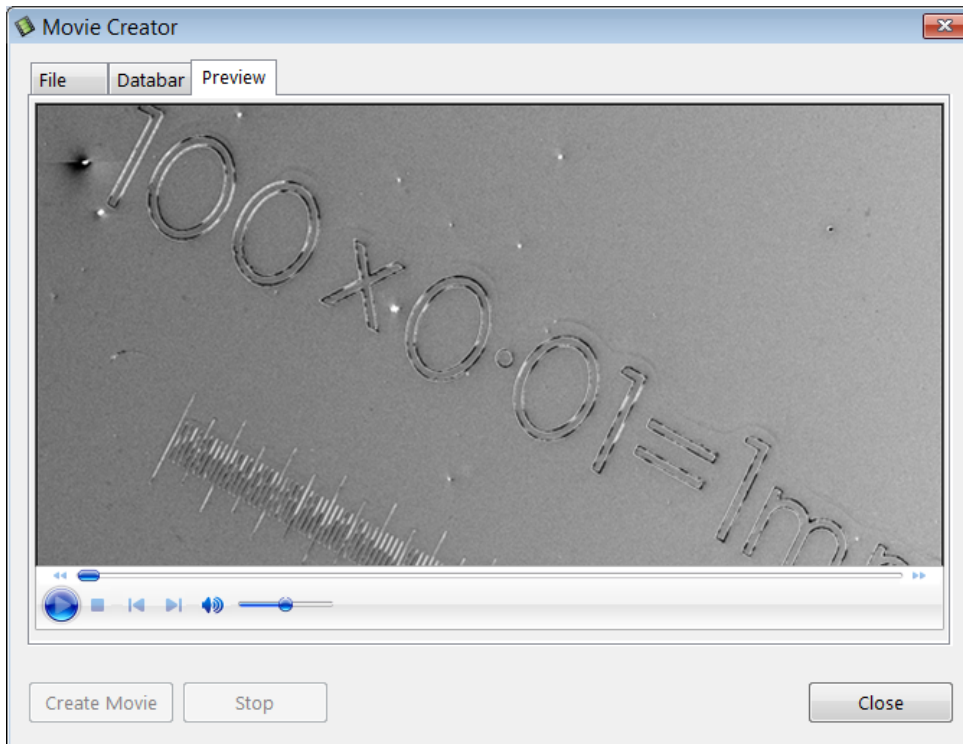


- *Available / Displayed items:* lists - all items that can be entered in the databar / are already present in the databar.
- *>/>> (</<<)* button -add one / all item(s) from the Available list to the Displayed list (removes one / all item(s) from the Displayed list back to the Available list).  
Since there is a finite amount of databar space, the area expands or contracts as other items are added to or removed from the Databar. Items exceeding the allowable space are ignored.
- *Move Up / Move Down / Top / Bottom* button - moves a position up / a position down / to the top / to the bottom in the *Displayed* list (a position to the left / a position to the right / to the left / to the right in the *Databar Preview*).
- *Label / Show Beam Icon / Micronbar* check boxes - set the show of the appropriate items in the Databar. The Micronbar scales to the magnification.
- *Units* button - sets the Units of Measure / Pressure / Temperature used in the movie Databar display.

## Preview Tab

Once the movie is set-up, opening the Preview tab automatically shows the first image of the movie sequence.

**FIGURE 5-15:** *Movie Creator dialog / Preview tab*



- *Start / Pause / Stop* button – starts / pauses / stops the movie play back. By dragging the adjuster, one can run forward or backward through the movie.

## Playing a Movie

The AVI file movie can be played in Windows Media Player or any another more advanced movie editing or playing program that recognises the \*.avi file type.

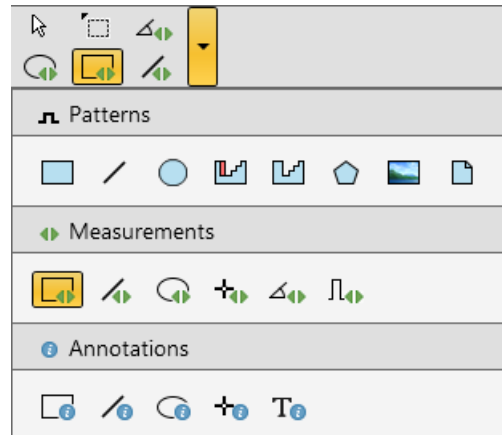
## Patterns / Measurements / Annotations

The toolbar *Patterns / Measurement / Annotation* items give a user many capabilities to draw pattern shapes, to measure distances, angles, diameters and areas and to locate and label items that are of significant interest on the sample area.

The selected tool is shown as the toolbar icon. Clicking on it activates (drawing mode – orange background) / deactivates (white arrow cursor – normal background) the tool. Clicking on the down arrow icon opens the list of available tools. The one chosen is activated from that time on, and the object can be drawn onscreen. To deactivate the drawing mode at any time, press the *Esc* (keyboard).

Each tool shows its description as a tooltip.

- *Patterns* – enable creating various pattern objects, which are prepared for subsequent processing.
- *Measurements* graphics – enable gaining dimension information about a specimen feature by overlaying it with a measurement object of different shapes. When changing the magnification, these objects resize accordingly.
- *Annotations* graphics – enable graphical highlighting and labeling of the items of interest with different shapes.



### Shape Creating

1. Choose the suitable *Patterns / Measurements / Annotations* graphic tool.
2. Draw the graphic over the area of interest.

This can be done by:

- clicking & dragging the cursor in any direction – this creates a rectangle shape
- Shift + clicking & dragging the cursor to any direction – this creates a rectangle shape that starts to grow from the point where you have clicked as its center.

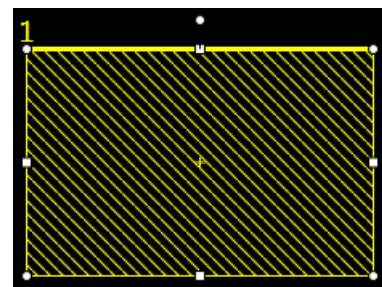
To create a text label, click the *T* annotation tool, create a rectangle area into which a text should fit, and start writing.

### Shape Editing

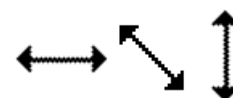
Once a Pattern / Measurement / Annotation object has been drawn, it can be adjusted in size and position over the area of interest. A number of appropriate properties are available in the *Property* editor, which can be changed by a selection from a drop down list or by direct precise editing of a text or a value.

To select all objects in the active display, press *Ctrl + A*. To delete selected object(s), press the *Delete* key.

The selected object is denoted by the addition of resizing handles (white rounded or square points) to the graphic outline. Moving mouse point cursor in the vicinity of these points forces the cursor to change:



- *Moving*: click inside the boundary of the object and drag it.  
*Note*  
*Holding the Ctrl + Alt keys while hitting any arrow key moves the pattern in a corresponding direction by a fixed distance.*
- *Rotating*: click on the object rotation control (white point in the middle above the graphic) and drag it.
- *Resizing*: click on & drag the resizing handle until the desired size is reached (horizontal / vertical / diagonal resizing cursor). Holding the *Ctrl* key while dragging forces the dimensions to be changed proportionally.





This section describes necessary microscope maintenance procedures that can be carried out by the microscope user. The user maintenance is at a minimum due to source and column design providing the long uptime. Therefore a complicated maintenance is normally a part of a service contract to be performed by a qualified service engineer.



### Caution!

Read and follow all instructions within the Apreo User safety manual carefully!

### Caution!

- Parts that operate in vacuum should be handled carefully using clean powder-free gloves. Parts not in use should be stored in suitable containers or packed in aluminum foil.
- The EDX window (option) is very fragile and must be protected from large pressure oscillations. Remove the detector before major cleaning activities is also recommended.
- Be aware of removing the chamber door locking screws, used during instrument transportation (labeled REMOVE)! If these are installed, an overpressure over 20 kPa (150 Torr, 0.2 bar) can arise inside the chamber during the vent procedure (N<sub>2</sub>). If installed, the overpressure is harmful to the EDX window.

#### Note

Gas back fill (N<sub>2</sub>) should be maintained while the specimen chamber is at ambient pressure. However, to avoid gas waste it is recommended that the chamber be left vented no longer than necessary.

## Cleaning procedures overview

### Caution!

Be aware of the electrical, thermal and mechanical hazards. Refer to the User safety manual for the details.

Frequency of cleaning is, in most cases, determined by necessity. The need for cleaning is shown by poor image quality or gross astigmatism levels. Recommended cleaning procedures are given below for parts that operate in vacuum and that are subject to possible contamination.

### Caution!

In case the safety interlock does not function properly, the message appears onscreen warning about possible presence of dangerous voltages inside the microscope chamber. **In this case do not touch parts inside the chamber and call service.**

## List of applied cleaners

- De-ionized or distilled water - H<sub>2</sub>O
- Ethanol - C<sub>2</sub>H<sub>5</sub>OH
- Ethanol p/a (Pro Analysis: 99.8% pure) - C<sub>2</sub>H<sub>5</sub>OH
- Isopropanol
- Neutral pH cleaning fluid (soap solution)
- CIF or Soft Scrub (fine abrasive household cleaner) or 0.05 µm aluminous powder

Table 6-1 Household Cleaners

Country	Name	Country	Name
Austria	CIF	Italy	CIF
Australia	CIF	Japan	CIF
Finland	CIF	Netherlands	CIF

Table 6-1 Household Cleaners

Country	Name	Country	Name
France	CIF	Switzerland	CIF
Germany	CIF	UK	CIF
USA	Soft Scrub		

**WARNING!**

The cleaning solvents ethanol and isopropanol are highly flammable! Do not use open flames and do not smoke while cleaning. Ventilate the room properly.

## Cleaning column parts

---

All column parts are polished before the instrument is delivered. For this reason, only occasional light polishing is required to remove contamination that may build up on components in the column and specimen chamber as part of normal operation. Any part that is exposed to the electron beam should be highly polished, and free of contamination and/or scratches that can charge and thus degrade the image.

**Caution!**

Users are allowed to clean the final lens pole only from the outside!  
Gold plated parts should not be polished with abrasive.

## Materials and technique

---

To polish components, place a lint-free cloth on a flat surface (a glass block is ideal) and apply a small amount of Soft Scrub or CIF and distilled water to the cloth.

Place the part to be cleaned on the polish and rub with a circular motion until all contamination is removed. For inner surfaces, use a cotton swab or wooden dowel as an applicator. A toothpick can be used for small holes.

Lint-free nylon (not cotton) or latex surgical gloves should be worn while handling parts to avoid contaminating just-cleaned surfaces. Tweezers should be used to hold small parts.

After the part has been polished, remove the Soft Scrub/CIF cleaner by washing in hot water. Inspect the part under a stereo microscope at 20× magnification to ensure that there is no remaining contamination or polish residue. Wash the part in de-ionized or distilled water in a beaker with an ultrasonic cleaner for several minutes. Transfer the part to a clean beaker with alcohol or isopropanol and clean ultrasonically again for several minutes.

When the components are dry (a compressed air “duster” can speed drying), reassemble and return them to the column. If a part is stained, heat it with hot water and immediately rinse with alcohol and dry using compressed air.

**Cleaning tips**

Parts exposed to the electron beam require periodic polishing. This will ensure maximum performance of the instrument for many years.

Do not use metal polishes such as POL or WENOL to clean parts, as these can leave outgassing material. Be aware that threaded surfaces should not be polished, as these do not contact the beam and are a source of outgassing if polish is trapped. Wash threads with alcohol or isopropanol if absolutely necessary.

After cleaning, inspect all parts for residue and stains using a light microscope.

## Cleaning stage mechanics

---

Checking the condition of the stage should be a weekly exercise, as many different samples may be exchanged in this time period. Some samples may be powders or composite materials that inadvertently drop particles on or in the stage. If a silicon wafer breaks in the chamber, it can shatter into hundreds of pieces. In this case the stage should be thoroughly mechanically cleaned, if there are any visible pollutions before attempting movement again.

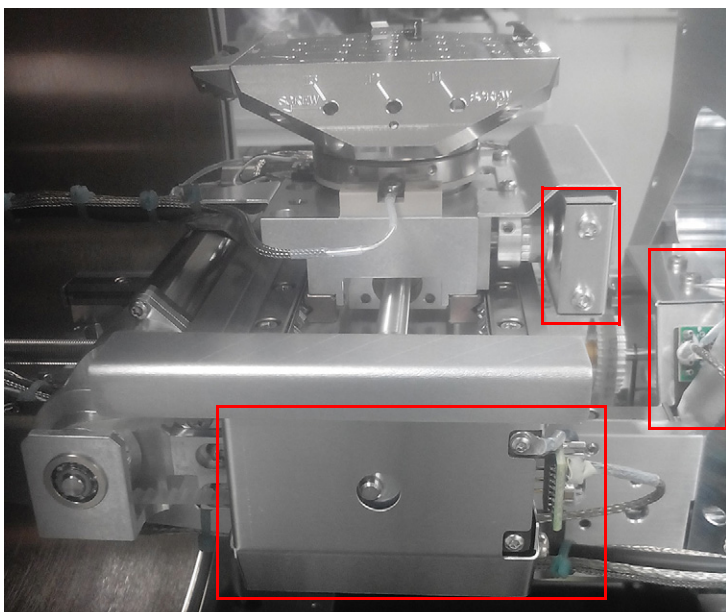
## Cleaning stage parts

Abrasive and solvents must not be used on the moving stage parts. Cleaning by a suction is the ideal method. If not available, cleaning should be done by using dry nitrogen gas bursts around the stage mechanics to blow out any foreign materials. Make sure the final lens and detectors are protected from the turbulence. Do not use sharp metal objects to scrape away debris. A fine pair of plastic tweezers can be used to pick up difficult particles. Spillage on the stage should be wiped up using a lint-free cloth, followed by suction or blowing with clean gaseous nitrogen.

### Caution!

*Do not perform mechanical cleaning of the stage nearby the encoders to prevent its damage.*

**FIGURE 6-1:** Sensitive stage encoders placement



### Cleaning stub holder

Recommended cleaning procedure is given below for parts that operate in vacuum and that are subject to possible contamination. Frequency of cleaning is, in most cases, determined by necessity (image quality or astigmatism level).

1. Loosen the stub holder with the use of 2.5 mm allen key.  
The bolt is hidden under specimen position No. 9. Hold the holder with hand to eliminate rotational force coming from loosening the bolt and applying stress on stage mechanics.
2. Clean the holder using a lint free cloth and a mild abrasive according to the list of applied cleaners (see above).
3. Rinse in tap water.
4. Clean in an ultrasonic cleaner for 5 minutes using distilled water.
5. Clean in an ultrasonic cleaner for 5 minutes using alcohol p/a or isopropanol.



### Caution!

*Do not place parts together in the beakers. Wash separately as damage can occur to the metal surfaces.*

6. Rinse in alcohol p/a.
7. First blow dry with a compressed air canister, then dry thoroughly under an infra-red lamp (from 15 min to 1 hr) at a temperature between 80 °C and 100 °C.

### Caution!

*Do not bake the stub holder in an oven!*

## Refilling water bottle

The water bottle in the instrument typically needs to be filled about once a month if the instrument is used on a regular basis in the Low Vacuum mode. The water reservoir is located on the left side of the microscope console, behind the cover. To fill the bottle, do the following:

1. Run the 154 - Water Bottle Venting alignment procedure (see Chapter 4).

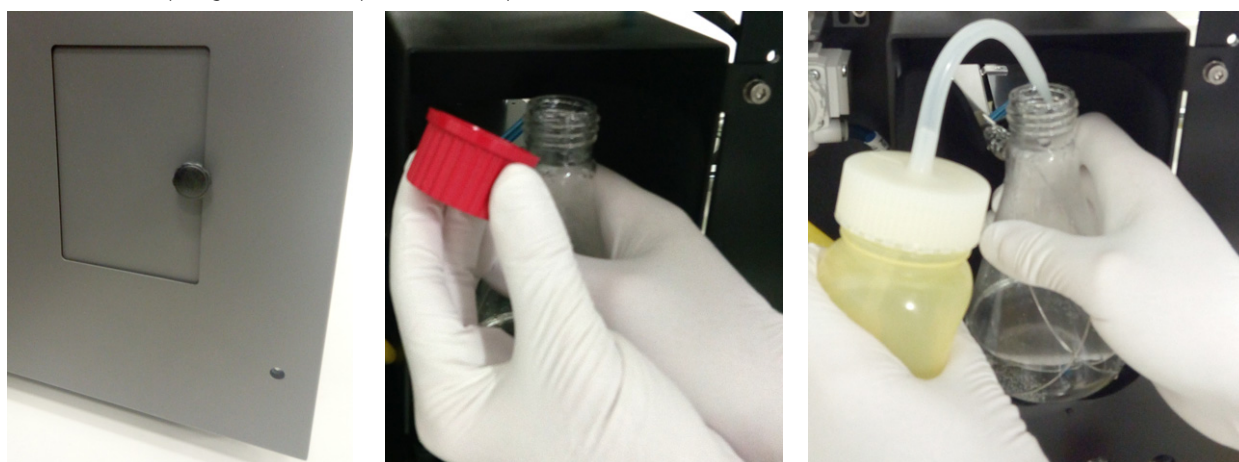
### Caution!

*Be aware of the gas type connected to the gas inlet before the Vent water bottle button is clicked! If you are not sure, disconnect the gas pipes from the gas inlet coupling.*

2. Open the Water bottle chamber cover.
3. Pull out the water bottle and remove the threaded cap.
4. Refill the bottle with distilled water (not de-ionized) until 1/3 full.



**FIGURE 6-2** Refilling water bottle procedure (steps No. 2-4)



5. Mount the cap and install the water bottle in the reverse order of that described above.
6. Pump the chamber. Switch to LoVac mode to force automatic purging to flush any air out of the bottle and connecting tubes.

### Note

*The first time the system is pumped to LoVac mode after filling the bottle, Auto-purging may be erratic until the bottle pressure has steadied. The removal of all the gas from the liquid must be accomplished before good imaging is possible. This has been done correctly when no bubbles are produced in the water when increasing the pressure in the chamber.*

This chapter covers hardware and software that is an option either integrated in, or accessory to the Apreo system (not all options are described here).

- *Support PC* – connects your workspace to the network and can hold some other software utilities.
- *Manual User Interface (MUI)* – provides direct manual control of microscope parameters such as focus, magnification, contrast, brightness, beam shift and correcting astigmatism.
- *Joystick* – brings another possibility for controlling the basic stage movements.
- *Electron Beam Current Measurement*
- *External Scan Interface*
- *Quick Loader*
- *Nav-Cam*
- *Patterning*
- *Gas Injection System* – Platinum Deposition, Tungsten Deposition, Insulator Deposition II, Delineation Etch, Insulator Enhanced Etch, Enhanced Etch, Carbon Deposition, Selective Carbon Mill, Gold
- *Uninterruptible Power Supply*
- *Mains Matching and Isolation Transformer* – provides a galvanic isolated AC-regulated power source with the 115 / 230 V, 50 / 60 Hz output.
- *Compressor 120 V / 230 V, 50 / 60 Hz 4-litre Tank*
- *Thermo Neslab Water Cooler 50 Hz / 60 Hz*
- *Acoustic Enclosure for Pre-vacuum Pump*
- *Specimen Holder Kit*
- *Set of 20 Specimen Stubs for SEM's*
- *UMB Stub Holder Kit*
- *CryoCleanerEC + spare vessel* – anti-contamination device
- *Plasma Cleaner*
- *Annular STEM detector* – allows detection of electrons transmitted through the sample. The regular voltage range which of course is dependent on the sample thickness, is from 30 kV down to around 5 kV.
- *Universal Lift-out Holder for STEM observation*
- *Trinity detector (T3)* – In Column detector especially suitable for the Beam Deceleration mode
- *Directional Backscattered Detector (DBS) – Angular (ABS) / Concentric (CBS)*
- *Thermal Printer Kit*
- *Remote Control / Imaging*
- *VolumeScope*
- *SIS Scandium Image software*
- *SIS Scandium desktop license*
- *Scandium Solution Height software* – enables creating of a topographic map of a sample
- *SIS webRacer* – allows regular users with ID / passwords (provided by the supervisor) to view and retrieve worldwide database data, using any internet browser and any computer system (PC, Apple, Sun...).
- *ResolveRT*
- *DualBeam Course – Acht*
- *Apreo Course – Hillsboro, Oregon / China / Japan*
- *Advanced Course DualBeam – Acht*
- *DualBeam Short Course – Acht*
- *On-site Training / Support – 1 day – North America / China / Japan*

For further up-to-date information on system options please contact your local Thermo Scientific representative.



## Manual User Interface

---

The Manual User Interface (MUI) provides knobs to perform functions that can also be performed with the software. It is connected to a USB connector located on the Microscope computer.

**FIGURE 7-1:** *MUI*



The MUI offers additional flexibility for controlling magnification, beam shift, focus, astigmatism, contrast and brightness.

## Joystick

---

The Joystick provides knobs to perform stage functions that can also be performed by the software. It is connected to a USB connector located on the Microscope computer.

**FIGURE 7-2:** *Joystick*

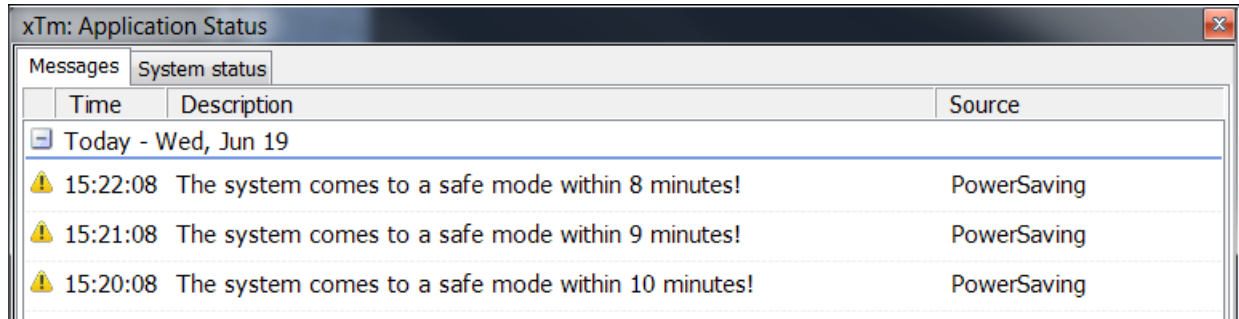


- Up / Down *lever* motion - moves the stage in the Y axis
- Left / Right *lever* motion - moves the stage in the X axis
- Clockwise / Counterclockwise *lever* rotation - rotates the stage clockwise / counterclockwise
- Button 1 - not used
- Button 2 is used together with the lever motion:
  - Up / Down moves the stage up / down (regardless of the Link Z to FWD status)
  - Left / Right tilts the stage (available for stages with motorized tilt axis movements)
- Button 3 speeds up the stage motion:
  - 10× in X / Y axis
  - 5× in Z axis
  - 2× in R / T axis

## Uninterruptible Power Supply (UPS)

If power failures occasionally occur, using the microscope UPS is recommended. It maintains the electron source section.

In case the microscope system is powered by the UPS and a mains power failure happens, the system starts a 10 minute countdown to switch to the safe mode. The user is informed of the countdown progress in the application status window. If the mains power is recovered within this time, the countdown is cancelled and nothing happens.



Time	Description	Source
Today - Wed, Jun 19		
15:22:08	The system comes to a safe mode within 8 minutes!	PowerSaving
15:21:08	The system comes to a safe mode within 9 minutes!	PowerSaving
15:20:08	The system comes to a safe mode within 10 minutes!	PowerSaving

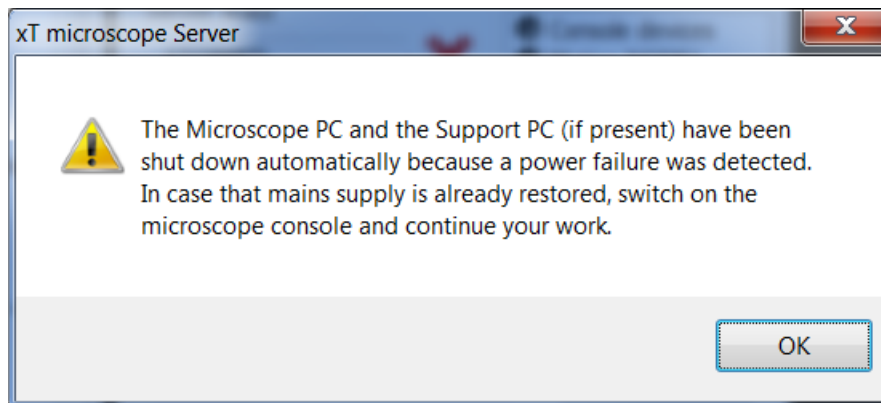
After 10 minutes of continuous power off, a shutdown to the safe mode with the following actions is activated:

- FEG emission is gently switched off
- Chamber is vented
- UI is stopped
- xT Microscope server is stopped
- Microscope console is switched off to Standby mode
- Microscope controller and the support computer (if present) are switched off

### **WARNING!**

*Because the Emitter IGP's are supported by the UPS, some parts of the microscope are still under power.*

To return the system to operation, follow the startup procedure (see Chapter 2). When the xT microscope Server is launched the first time from the safe mode, a dialog is shown to inform a user.



#### Note

*A Supervisor must restart the system after a longer power failure. If the Startup procedure fails, contact an Thermo Scientific Service Engineer.*



## Optional Detectors

It is possible to extend the Apreo microscope system with some detectors, depending on user needs.

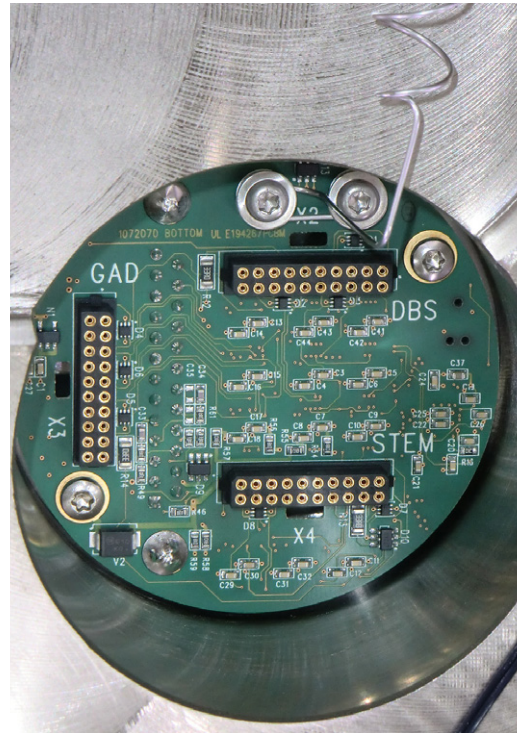
### Optional detectors connection

Detectors are connected to the feed-through connector board. Connectors have printed names and are used to connect the following detectors (UI representation):

- **GAD**: Directional GAD (GAD-ABS / GAD-CBS)
- **DBS**: Directional BackScattered (ABS / CBS)
- **STEM**: Scanning Transmission Electron Microscopy (STEM 3 / STEM 3+)

#### **Caution!**

*Connector insertion is a service operation!*

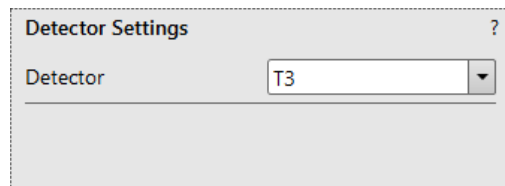


### Trinity Detector T3

Electrons generated by a primary beam can be collected by the in-column Trinity detector T3 that is located inside the column, just below the aperture strip. It is useful in the OptiPlan column Use Case.

It is ideal for use together with the Beam Deceleration mode (BD) and Standard Use case and with/without BD in the OptiPlan Use case, when standard off-axis secondary electron (SE) detectors fail.

In BD mode with stage bias above 2.5 kV, the detector detects SE; without BD the detector collects the BSE signal. Optimum WD should be from 3.5 to 7 mm to achieve maximum detection efficiency. Due to geometrical restrictions, higher probe currents and HV over 4 kV should be used.



## RGB Cathodeluminescence detector (CLD)

CLD is a high sensitivity photomultiplier sensor dedicated for detection of light induced by primary beam. It is provided as a retractable optional detector. CLD is primarily used in HiVac, basically it can be used in any vacuum mode.

**FIGURE 7-3** CLD inserted



### Detector Settings

When a detector insertion is not allowed, tooltip is given.

Detector insertion not allowed:  
Please link Z to FWD

CLD offers following basic modes which can be run in parallel:

- Red mode (red part of the visible light spectrum is detected)
- Green mode (green part of the visible light spectrum is detected)
- Blue mode (blue part of the visible light spectrum is detected)
- Panchromatic

Additionally following summing modes are supported:

- Green+Blue
- Red+Panchromatic

Finally, following settings are provided, which helps the operator to set all four displays with one button:

- Total Signal
- Color Imaging

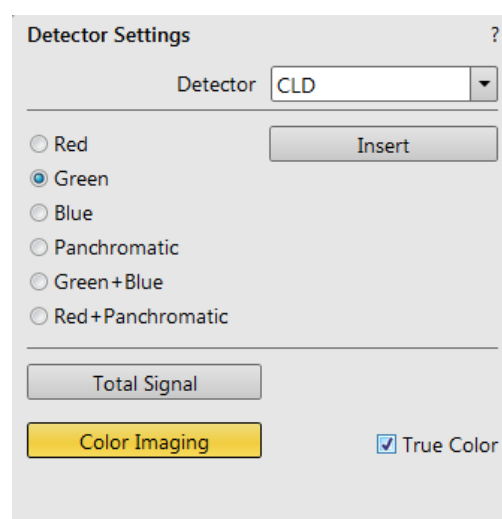
Sets displays for acquisition of maximum CL images:

Display 1: CLD (Red+Panchromatic); Display 2: CLD (Green+Blue); Display 3: Mix (1+2)

Sets displays for acquisition of color CL images:

Display 1: CLD (Red); Display 2: CLD (Green); Display 3: CLD (Blue); Display 4: Mix (1+2+3)

- When Color Imaging is set (button highlighted in yellow), the *True Color* check box can be ticked – in this case display 4 shows balanced color imaging of the sample (RGB channels contrast and brightness for the highest values are set to give white color).



## Directional Gaseous Analytical Detector (GAD)

This is a lens mounted low voltage silicon diode with an active area of approximately 100 mm<sup>2</sup>, that can be used at pressures above 10 Pa. It is positioned directly over the sample to obtain maximum detector efficiency.

**FIGURE 7-4:** Directional GAD Diode



The GAD can be used down to a high voltage about 1 kV and works best with slow scan conditions.

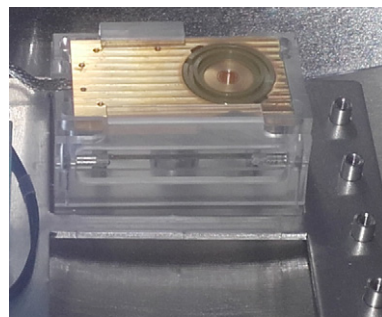
It can be used for HiVac, but because it limits the minimum achievable WD, it is disadvantageous for high resolution imaging. It has a 500 μm PLA cone for LoVac operation, especially the X-ray analysis. The cone extends down from the unit to 7.5 mm, which reduces the gas path length for electrons to an efficient 2.5 mm at the standard WD = 10 mm.

### Installing / Removing

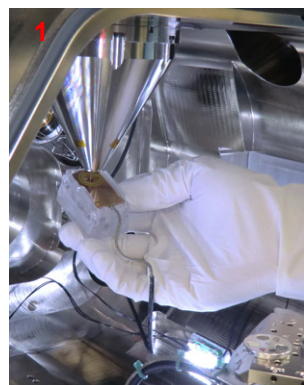
When not used, the GAD is placed at its parked position (inside the chamber at the bottom right side) in the protective plastic box to prevent it from being polluted. The cables are permanently connected to the feed-through connector board by Thermo Scientific service.

1. With your gloved hand grasp the detector in the protective box.
2. Push the mounting collar gently up to the objective lens cone. The part with the connector cables faces towards the chamber door.
3. Push the sides of the protective box and release the installed detector.

When removing the detector, proceed in reverse.



**FIGURE 7-5:** Directional GAD detector installation



### Caution!

The diode is sensitive to mechanical damage. The active area (shiny diode) should never be touched.

The GAD is mounted close to the (optional) X-ray detector collimator, which must not be touched when changing detectors. It is advisable to retract the EDX collimator when mounting / removing the detector on / from the objective lens.

## Detector Settings

- Select the GAD-ABS from the *Detector Settings* module / *Detector* list box / GAD-ABS or GAD-CBS detector.

Choose the required diode segment(s) by clicking the relevant radio button:

- All is the normal BSE image with suppressed topographical contrast and maximum atomic number contrast.
- Inner / Outer uses shadows to create strong topographical and atomic number contrast.
- A / B / C is the pseudo-topographical image with suppressed atomic number contrast and maximum topographical contrast.
- Custom 1 / 2 can be set by a user by clicking the selected segments to add signal to (+ yellow background) / subtract signal from (- blue background) the overall detector signal. Clicking on the same (+ / -) sign again turns the segment background gray; this segment sends no signal.

### Note

Setting segments to subtract signal is allowed only for Custom 2. Set combination remains stored under the particular user.

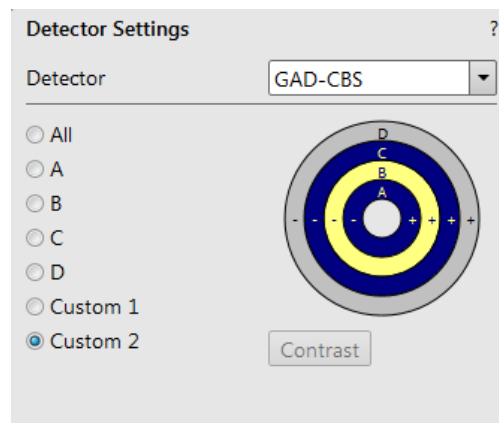
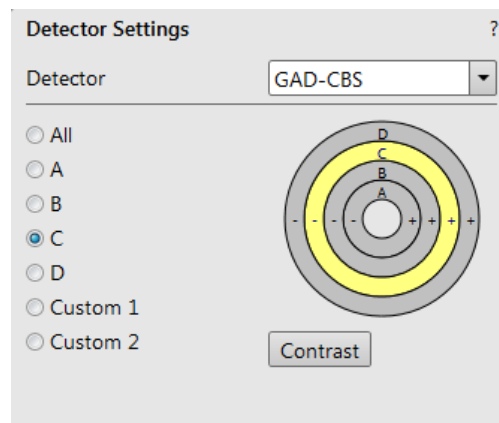
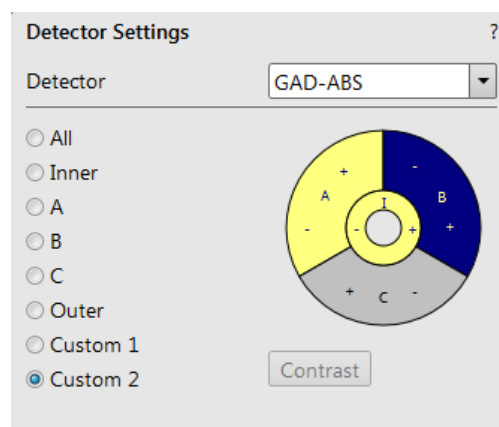
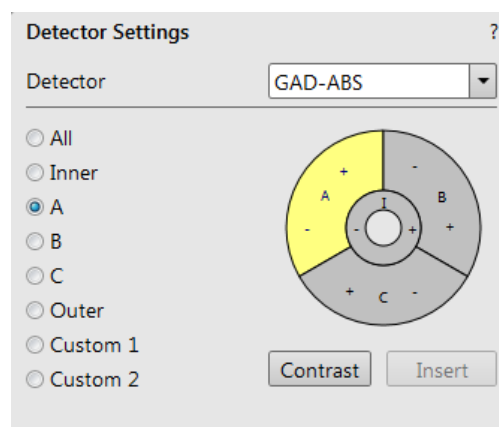
- The *Contrast* button equalizes signals (contrast) from different segments so they do not to override one another and have the same contrast in different displays in which the GAD-ABS / GAD-CBS detector is used.

Distribution of electrons collected by detector segments changes with setting the working distance, lens mode and Beam Deceleration mode.

It is also possible to set different segments in particular displays and thereafter to use the *Enhanced Image* module / *Mix 3* or *Mix 4* tab to mix color coded signals to create color images.

### Note

Whenever the GAD is selected, the optical display is paused (because the CCD camera infra-red LED's are switched off so as to not emit photons that might saturate the detector diode).





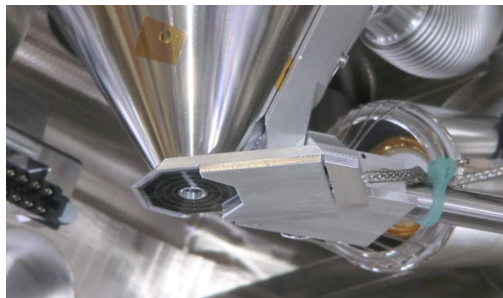
## Directional Backscattered Detector (DBS) - Angular Backscattered Detector (ABS) Concentric Backscattered Detector (CBS)

The ABS uses angular segmentation of the detector diode to distinguish topographic contrast from different signal directions.

The CBS uses concentric segmentation of the detector diode to distinguish between BS electrons scattered close to the beam axis - inner segment (preferentially composite contrast) and electrons scattered far from the beam axis - outer segment (more topographical signal).

### Caution!

Be aware of sample and final lens collision when tilting large samples!



### Detector Settings

- Select the *Detector Settings* module / *Detector* list box / *ABS* or *CBS* detector.

Choose required diode segment(s) by clicking the relevant radio button:

- All* is the normal BSE image, with suppressed topographical contrast and maximum atomic number contrast.
- Inner / Outer* uses shadows to create strong topographical and atomic number contrast.
- A / B / C* is the pseudo-topographical image with suppressed atomic number contrast and maximum topographical contrast.
- Custom 1 / 2* can be set by a user by clicking the selected segments to add signal to (+ yellow background) / subtract signal from (- blue background) the overall detector signal. Clicking on the same (+ / -) sign again turns the segment background gray; this segment sends no signal.

### Note

Setting segments to subtract signal is allowed only for *Custom 2*.

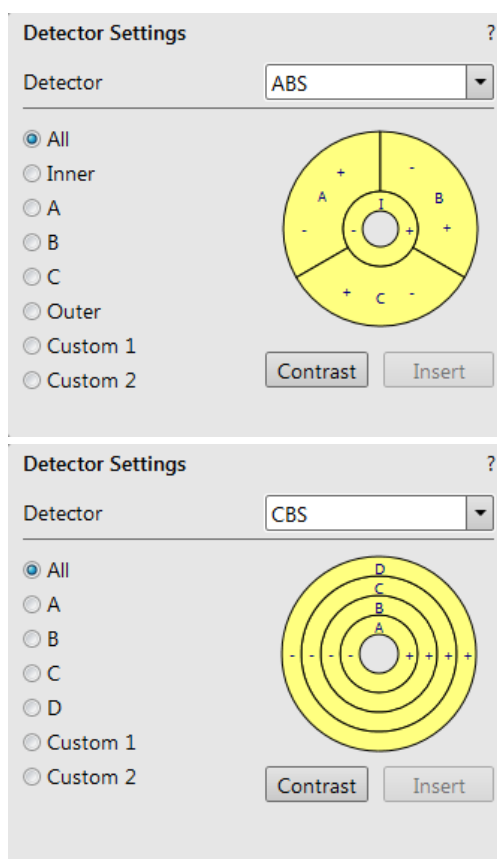
A set combination remains stored under a particular number and user.

- The *Contrast* button equalizes signals (contrast) from different segments so they do not to override one another and have the same contrast in different displays in which the *ABS / CBS* detector is used.

The distribution of electrons collected by the detector segments changes with the setting of the working distance, the lens mode and the Beam Deceleration mode.

It is also possible to set different segments in particular displays and thereafter to use the *Enhanced Image* module / *Mix 3* or *Mix 4* tab to mix color-coded signals to create color images.

When the detector is retracted, the information text is shown in each display that uses it.



**CBS detector retracted**

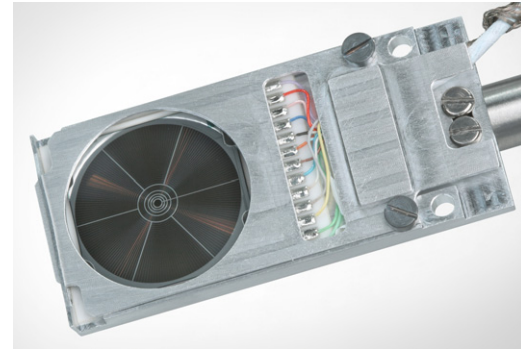
## Retractable Annular Scanning Transmission Electron Microscopy Detector (STEM 3 / STEM 3+)

This is a solid-state diode mounted on a retractable arm. The STEM 3 detector uses a central circle, one concentric ring and 6 angular segments of the detector diode while the STEM 3+ detector uses the central circle and 5 concentric rings.

### Inserting and Retracting STEM 3 / 3+ Detector

#### Caution!

Always take care of any stage movement that can cause a collision with the STEM 3 / 3+ detector. Any collision can cause damage to the detector!

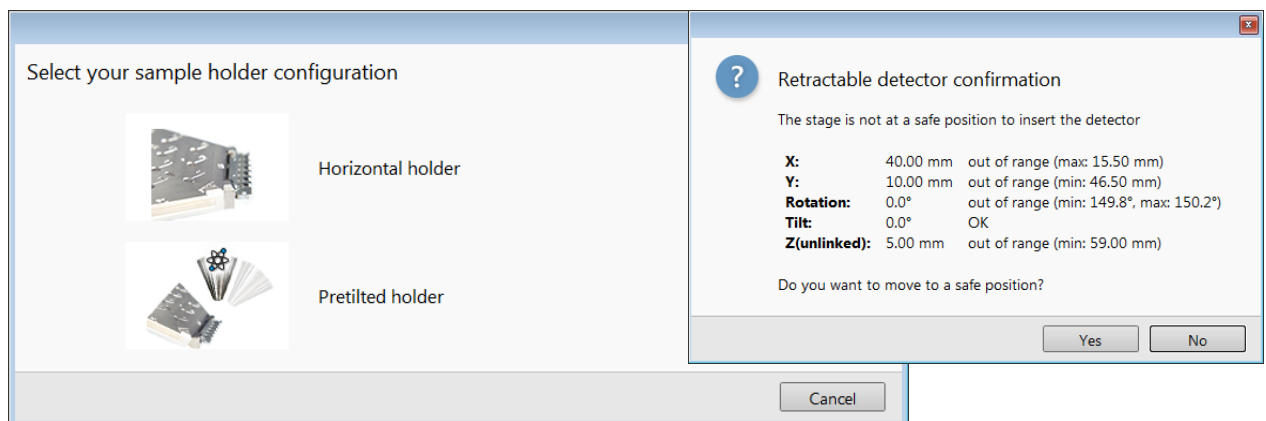


#### Note

When the STEM 3 / 3+ detector is inserted, stage rotation and tilt are locked automatically for safety.

Before insertion of the retractable STEM 3 / 3+ detector, the chamber must be pumped, otherwise the *Insert* button is not accessible (a tooltip occurs under the mouse cursor).

When clicking on the *Insert* button, the dialog requires determination of the correct *sample holder configuration* to enable safe detector insertion. When the stage is not in the correct position for insertion, another dialog appears requiring confirmation of moving it to the safe position.



The Tilt and the Z-axis stage movements are limited to enable safe stage movements.

Retraction of the STEM 3 / 3+ is automatic when Stopping / Starting the server or venting the chamber. Otherwise a user can use the *Retract* button. When the detector is retracted, this information text is shown in each display that uses it.

**STEM 3 detector is retracted**

## Settings for STEM 3 / 3+ Detector

The detector works best under slow scan conditions.

1. Position the desired sample grid in the field of view using the ETD. Focus and link Z coordinate to FWD.
2. Select the *Detector Settings* module / *Detector* list box / *STEM 3* / *STEM 3+* detector.
3. Insert the STEM 3 / 3+ detector.

### Bright Field

1. Click on the *Bright Field* radio button.
2. Adjust the contrast and brightness. An image should be visible at low magnification.
3. Change the voltage to suit the contrast necessary over the sample.

For example, light materials (poly-silicon or silicon oxide) may work better with 5 - 10 kV to create contrast, while dense materials (metals) might require 10 - 20 kV or higher.

4. Set the desired magnification, fine focus and correct the astigmatism.

### Dark Field 1 / 2 / 3 / 4

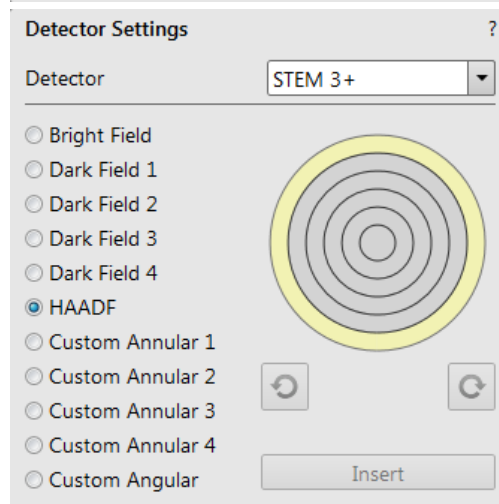
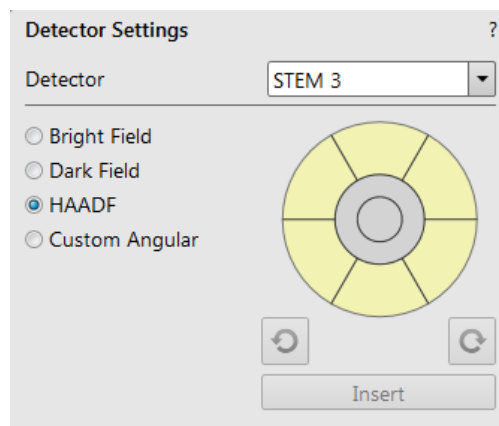
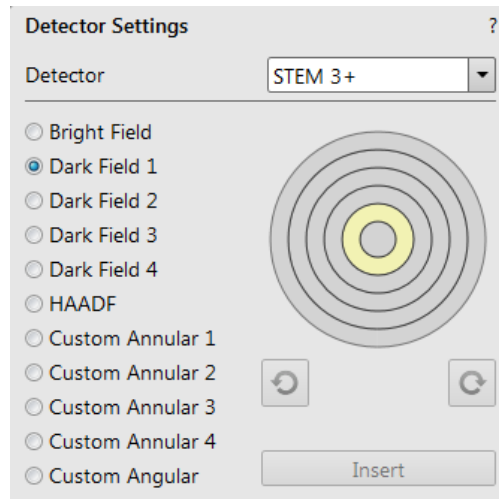
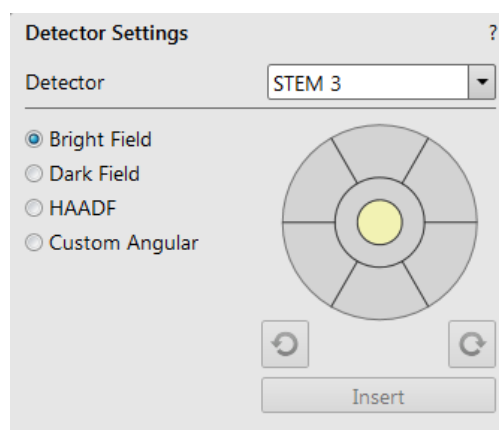
In this mode, it is possible to use separate segments by selecting the appropriate radio button.

1. Obtain a Bright Field image first.
2. Click on the *Dark Field 1 / 2 / 3 / 4* radio button.
3. Adjust the contrast and brightness.

### HAADF (High Angle Annular Dark Field)

This mode may require higher voltage to create a suitable image, as the angle subtended to the detection diode can be wide. Choosing 2× the value used for Bright field is a good guide level. HAADF segments cannot be combined with DF or BF.

1. Obtain a Bright Field image first.
2. Click on the *HAADF* radio button.





**Custom Annular 1 / 2 / 3 / 4**

These buttons uses separate variations of segments adjustable by clicking any segment:

- Click on the *Custom Annular 1 / 2 / 3 / 4* radio button.
  - + sign - segment signal is added (yellow color)
  - sign - segment signal is subtracted (blue color)
  - no segment signal (gray color)

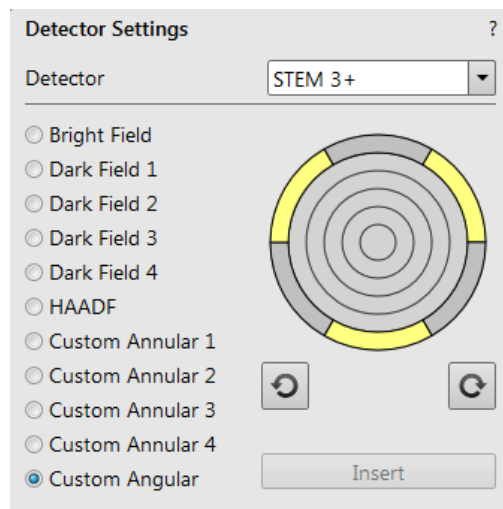
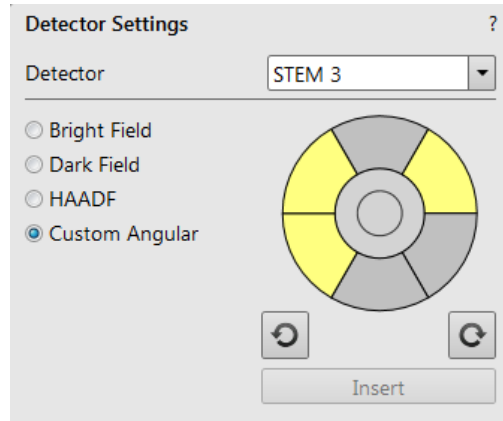
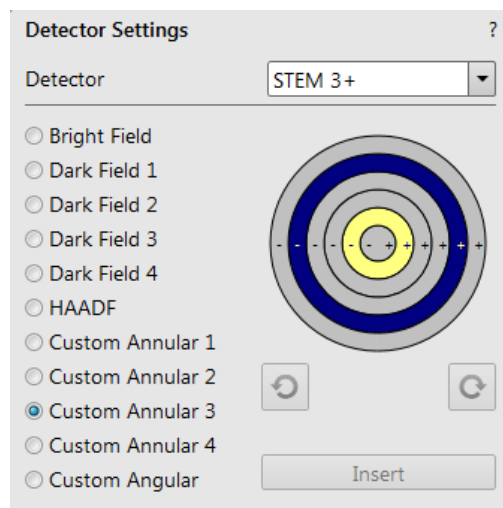
The combination set remains stored under the particular user.

**Custom Angular**

- Click on the *Custom Angular* radio button.

You can select / deselect any combination of outer segment partitions by clicking on them in the detector diagram. Selected segments are highlighted in yellow.

The entire area of the selected segments can be “rotated” using the circle arrow buttons to view orientation contrast changes.



# Nav-Cam

Besides the Sample Navigation / Navigation Montage feature, this functionality represents a fast method to navigate across a large stage movement area. It provides a quality Navigation image quickly and easily, which is convenient when investigating large area samples or several samples with the use of any multi-sample holder.

## Note

Nav-Cam operation is restricted for highly shiny and simultaneously planar specimens (Si wafers, mirrors etc.).

## Capturing Navigation Image Procedure

1. Vent the chamber, open the chamber door, insert a sample and pump the chamber.
2. Select the *Stage* menu / *Move Stage to Nav-Cam* function to move the stage to the Nav-Cam position.

At this moment, the beam and the detector change to Nav-Cam and a live image from the navigation camera is obtained in the active display (with a resolution of 768 × 512 pixels only). Set the *Detectors* module / *Brightness* slider in case the imaging is not satisfactory.

## WARNING!

Retract all retractable detectors to prevent equipment damage!

## Note

Run the *Stage* menu / *Take Nav-Cam Photo* (Ctrl + Shift + Z) item to run steps 2, 3 and 4 automatically at once. It is possible to cancel this procedure with the *Abort* button at any time; the stage then remains in its present position.

3. Capture the Navigation image (with the high resolution of 3072 × 2048 pixels) by using the *Snapshot* / *Photo* function. The image can be saved or adjusted like any other image taken from the microscope (image enhancement, process, etc.). It is possible to capture the Navigation image after the *Home Stage* procedure has been run. For better image quality and navigation accuracy, running the *Link Z to FWD* is also recommended.

## Note

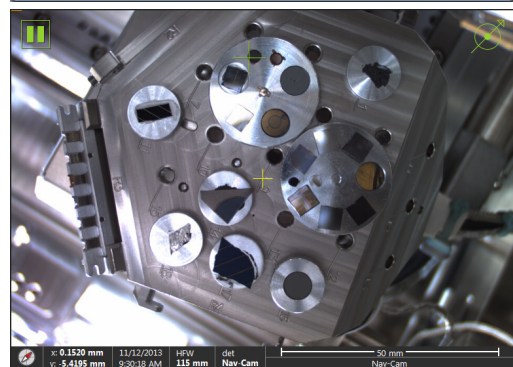
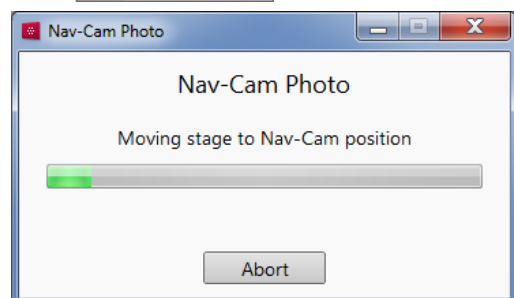
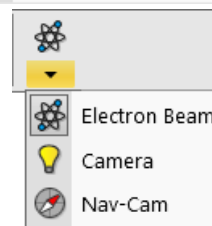
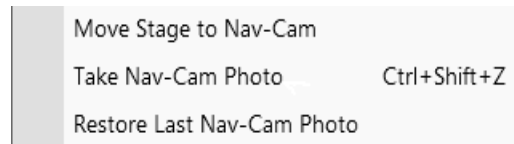
Wait until image capturing is finished (about several seconds).

4. Click on the *Stage* menu / *Move Stage to Nav-Cam* function again to move the stage to the previous stage position. A green rectangle (or just a cross) represents the spot where the electron beam is aimed.

Besides a navigation image the *Digital Zoom* module can be applied to navigate the stage.

When the *Preferences* / *General* section / *Show Stage Map in Navigation displays* item is set to *Yes*, saved stage positions are shown in the Nav-Cam photo.

In case a user logs off and the sample and its stage loading position did not change, use *Stage* menu / *Restore Last Nav-Cam Photo*.



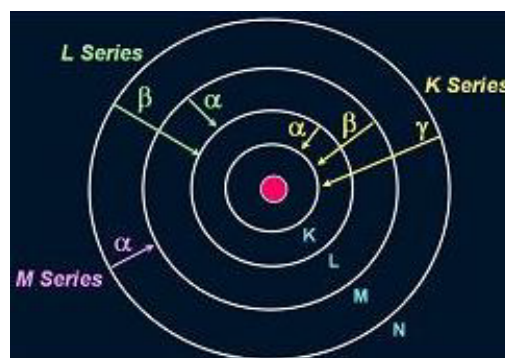


## Energy Dispersive X-ray (EDX) Analysis

The EDX (sometimes also referred to as EDS analysis) is a technique used for identifying the elemental composition of the specimen, or an area of interest thereof. It works as an integrated feature of a scanning electron microscope (SEM), and cannot operate on its own without the latter.

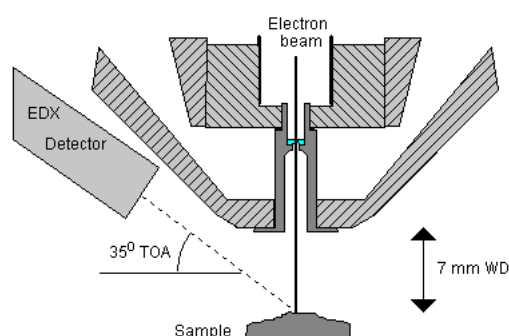
The specimen is bombarded with an electron beam inside the microscope column. These electrons collide with the specimen atoms' own electrons, knocking some of them off in the process. Positions vacated by ejected inner shell electrons are occupied by a higher-energy electron from an outer shell, while giving up some of its energy by emitting an X-ray. The amount of energy released depends on which shell it is transferring from / to. The atom of every element releases X-rays with a unique amount of energy. This identifies it.

The output of an EDX analysis is an EDX spectrum, which is just a plot of how frequently an X-ray is received for each energy level. The higher the peak in a spectrum, the more concentrated the element is in the specimen.



### High Vacuum

HiVac operation gives the most accurate X-ray results, but the sample must be electrically conductive.



### Low Vacuum EDX Analysis

X-ray analysis in LoVac mode is possible in combination either with the standard LVD detector or with the optional GAD detector. The GAD is recommended for achieving the best signal-to-noise ratio, especially when using lower accelerating values, because the long GAD cone minimizes the primary beam path and therefore the path's dispersion in the gaseous environment of the chamber. On the other hand, the LVD detector offers the largest field of view for the LoVac operation. The CBS is compatible with EDX.

The X-ray analysis should be performed at the lowest possible gas pressure to minimize interaction of the electrons with the chamber gas. Normally, it is performed with a relatively high beam current so that there will be enough signal for a good LVD image even at very low gas pressures.

### STEM EDX Analysis

Set the sample surface to 7 mm WD.

Select the area of interest in the STEM mode and perform X-ray analysis, mapping or line scans as appropriate.

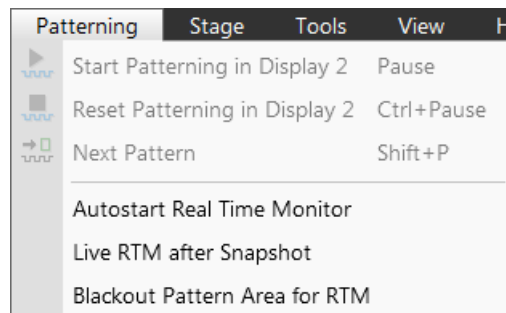
Because the samples are not bulk in nature, the beam spread normally associated with SEM samples is greatly reduced, and therefore higher spatial resolution can be obtained with the STEM detector. This also provides less background in the spectrum and allows better separation of peaks as well as more accurate lower count rate mapping. The high voltage chosen for the analysis still depends mainly on the composition of the sample.

## Patterning

With this option, the Patterning menu, the Patterning page and some toolbar icons are available within the UI to enable control over the entire process.

Patterning is the process of moving a beam over a defined pattern along the specimen surface (while leaving other areas untouched) with the purpose of *deposition*, adding well-defined amounts of new material. The pattern is shown in color appropriate to the gas selected.

The *Patterning* menu and the *Patterning Control* module control the entire process.



### Caution!

*When depositing a large volume of material at higher currents, we recommend removing any detector not in use. There is a risk of decreasing a detector's efficiency by material deposition.*

The system provides additional monitoring possibilities:

- *Simultaneous Patterning and Imaging (SPI)*

The SPI provides an electron imaging (in a display different from patterning) during patterning. It is strongly influenced by secondary electrons (SE imaging), so the image quality is not perfect. Higher electron currents (higher spot numbers) and averaging help improve imaging. In case the BSE detector is used, this interference is less important (BSE imaging). The system remembers the brightness and contrast settings separately for SPI or normal imaging.

- *Integrated Real Time Monitor (RTM)*

The RTM provides an immediate image (in the same display with the patterning) of the patterning process. The patterned area is observed, and in case of relatively slow scanning, the scan trajectory can be inspected.

RTM is typically used as an end-pointing device by observing brightness differences in the detector signal. These result from contrast differences when milling through layers of different composition on a stack of multiple materials.

RTM can be used with any of the pattern types that are available in the UI. When starting patterning with the RTM activated, the pattern in the UI will be updated with real time image information. The patterned area information is updated based on the detector signal, which is shown in synchronization with the beam trajectory.

It is possible to grab a snapshot with the electron beam during patterning while using RTM.

### Note

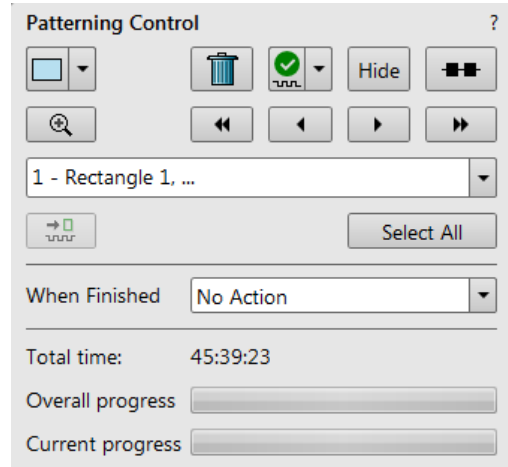
*The acquired data are matched to the calculated positions of the corresponding milling points. The pixels shown on the screen might not therefore directly match what is happening on the sample surface, and some imaging artefacts (due to milling points and screen pixels mismatch) can occur. To prevent this, try to change the field of view.*

## Patterning Control module

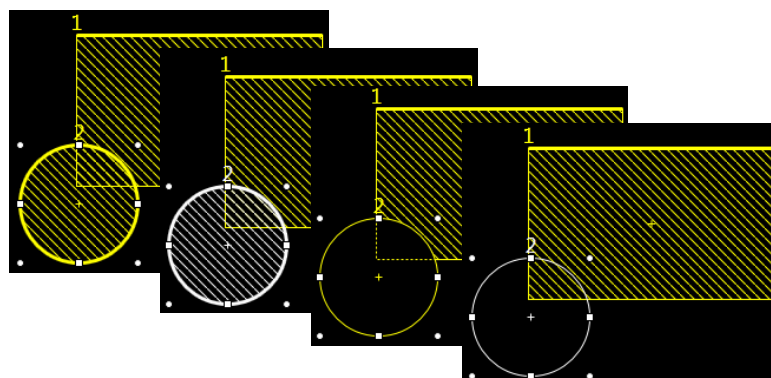
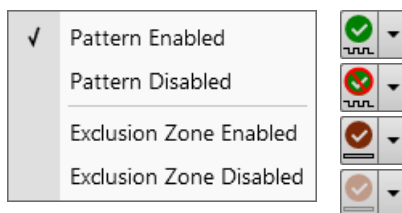
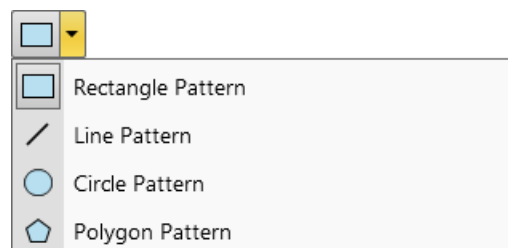
There are several tool icons and the progress monitoring area within the module.

### Tool Icons

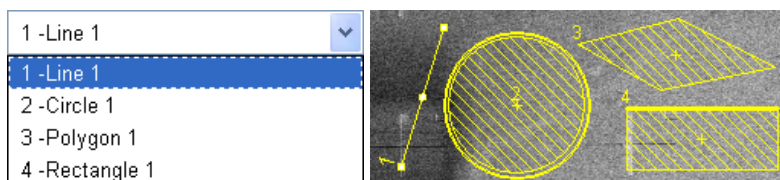
Clicking on an icon activates (highlighted with an orange background) / deactivates (normal background) the tool. If no icon is selected, the pattern selection cursor (arrow) is active.



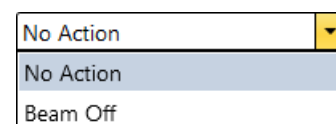
- *Pattern type selector* (also see Toolbar icons) – clicking on the down arrow next to the icon activates the drop down list to select a pattern type:  
*Rectangle / Line / Circle / Polygon / Bitmap / Stream File*
- *Trash Can (Delete)* button – deletes the selected pattern(s)
- *Pattern / Exclusion Zone* (overlapping area of the two patterns) *Enabled / Disabled* button – sets selected pattern / exclusion zone between two patterns to be / not to be processed



- *Hide* button – hides / shows all patterns; the button becomes highlighted / normal background
  - *Patterning Serial / Parallel sequence* button – switches between two possibilities
  - *Zoom* button – enlarges the selected pattern(s) to fill the entire display
  - *Patterning sequence* buttons – sets the process order of the active display patterns
- Patterns are milled in the order they are created. Numbers are shown close to the pattern and in front of its name to indicate the actual milling order. This can be changed by clicking on the left / right arrow to move the selected pattern one position up / down and by clicking on the left / right double arrow to move it to the first / last position.



- *Skip to a next pattern in order* button
- *Select All* button – selects all pattern shapes within the active display
- *When Finished* list – When a long lasting patterning is processed, select an action to proceed: No Action / Beam Off (sets the beam off).





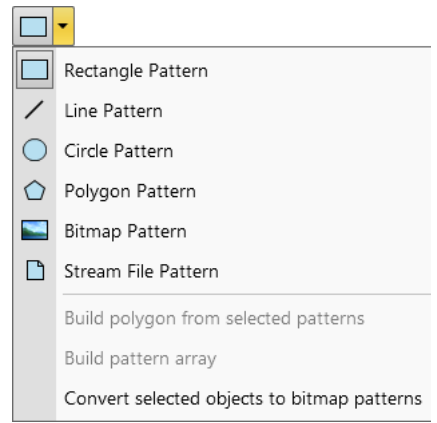
**Pattern Types**

Patterns are automatically assigned to one or more particular processes. They are distinguishable by a different crosshatch within the display.

The **Rectangle / Line / Circle / Polygon** pattern is dedicated to both milling and deposition.

The **Bitmap** pattern enables importing bitmaps as a pattern. It must be 24 bit RGB bitmap, each pixel consists of:

- Red component - actually not used
- Green component - determines if the beam is blanked. Any value other than 0 activates the beam
- Blue component - determines the dwell time per pixel:
  - If the value is 0, the pixel is skipped (no milling or deposition proceeds).
  - If the value is 1 (border), the dwell time is the lowest (approx. 100 ns).
  - If the value is 255 (border), the dwell time is identical as it is set for the pattern.
  - The dwell time for values in between the border values is linearly interpolated.



**Note**

When drawing a bitmap, we recommend using black (0 / 0 / 0) for no milling points and white (255 / 255 / 255) for milling points.

Do not forget to optimize other properties, such as the Application file, Z size, leading edge, etc.

The **Stream File** pattern is created as an ASCII text or binary file that directly addresses the patterning DAC (Digital Analog Converter) and produces custom pattern files. The 16-bit DAC is used, so the patterning field is divided into 65 536 steps in both the X- and Y-axes.

s16	96 2867 2867	96 1639 2048	96 2457 1639
40	96 1229 2457	96 2048 2048	96 2867 1639
25	96 1639 2457	96 2457 2048	96 1229 1229
96 1229 2867	96 2048 2457	96 2867 2048	96 1639 1229
96 1639 2867	96 2457 2457	96 1229 1639	96 2048 1229
96 2048 2867	96 2867 2457	96 1639 1639	96 2457 1229
96 2457 2867	96 1229 2048	96 2048 1639	96 2867 1229

The file must begin with an s, indicating a stream file. The second line defines the number of loop repeats (40x). The third line indicates the total number of X, Y coordinates (pixels) in one loop (5 x 5 = 25 in this case). The 96 figure represents the dwell time in units of 100 ns (=9.6 μs).

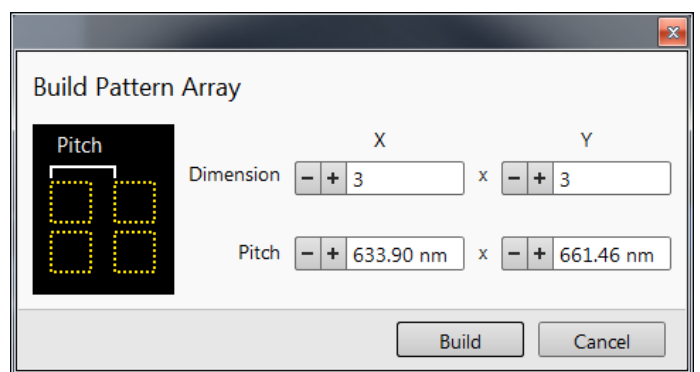
**Note**

Stream files cannot be created directly from the UI; use any suitable text processor. There are several stream file types that are recognizable by the first header line (s16 / s16,25ns / s16,DAC / s16,25ns,DAC).

When two patterns overlap, it is possible to join them into one by using the *Build Polygon* functionality.

Selected patterns can be multiplied by using *Build Array* functionality. The Dimension / Pitch means the number of repetitions / distance.

It is possible to convert any selected Annotation or Measurement graphic to a Bitmap type pattern shape with the use of the *Convert from Annotation* item.





**Serial Patterning**

All patterns defined on the screen are processed *consecutively*; milling / deposition is completed on one pattern before moving to the next one. This is the default patterning mode.

**Parallel Patterning**

All patterns defined on the screen are processed *concurrently*; one pass of the beam is completed on all patterns before moving on to the second pass. Parallel patterning is typically used to avoid a redeposition of material on adjacent areas.

With parallel patterning, the mill time is recalculated to include all the patterns that are shown in the image window.

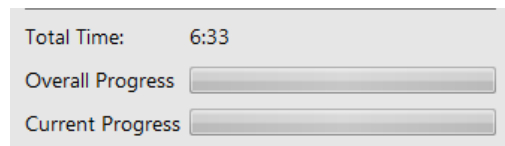
When a user switches to the Parallel mode, the following pattern properties in the group must be the same: *Gas Type* and *Passes*. The first selected pattern determines these values for all the other patterns.

Other properties (*Application*, *Z size*, *Overlap*, *Saturation Sputter Rate* and *Refresh Time*) are also all set to those of the first selected pattern to avoid confusion, even though they can theoretically remain unchanged. Restoring Serial mode does not undo these changes; the properties remain as in the Parallel mode.

**Progress area**

Information updated as the milling progresses can be found here (captions change according to a running process):

- *Total Time* - estimated total patterning time
- *Overall Progress* - related to the total patterning time of all patterns
- *Current Progress / CCS Line Progress* - related to the actual pattern in progress

**Note**

*When patterning is paused in one display, it is possible to start patterning in another one. Similarly, when patterning finishes, there may still be a paused patterning in another display.*

It is possible to acquire an image from the signals generated during patterning. All imaging parameters are dictated by the patterning requirements. Much better images can be acquired by a Snapshot during patterning. In this case, patterning is paused, an image is grabbed, and patterning resumes.

**Note**

*If the magnification is too high, creating certain patterns can use too much memory needed for the control system to run. The pattern corners become round, and the edges become jagged. A good rule of thumb is to pick a magnification where your pattern fills 35-50% of the screen.*

## Patterns Processing

Once a pattern shape has been drawn, it can be modified (see Shape editing above).

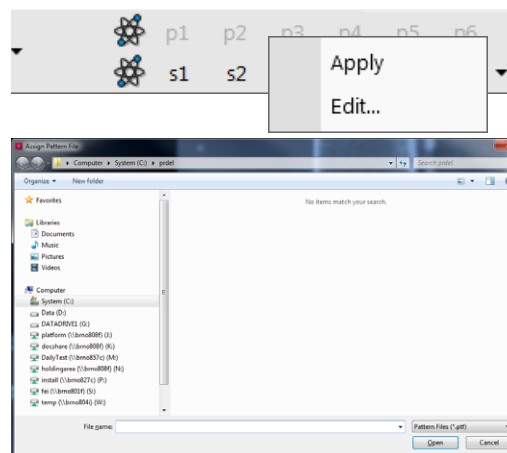
### Importing / Exporting patterns

User created patterns may be imported or exported (saved) via the *File* menu / *Import* or *Export* / *Patterns* item. The saved file (.ptf) contains all parameters found in the Patterning property editor (Basic / Advanced) for all patterns drawn in the active display. Six (for each beam) toolbar *Pattern Presets* (labeled p#) can be individually assigned to any of these .ptf files.

Right-clicking on the selected button calls up the menu:

- *Apply* item - activates an appropriate button (highlighted with an orange background) and starts the patterning with the preset parameters (the same as clicking on the button directly)
- *Edit* item - opens the *Assign Pattern File* (.ptf) window to assign a desired parameter file to a selected button

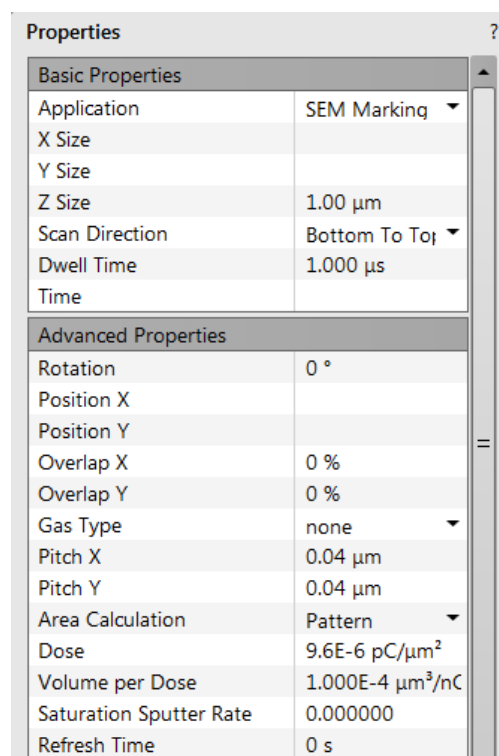
The toolbar Pattern Presets assignment to the particular .ptf file can be saved or loaded by the *File* menu / *Export* or *Import* / *System Parameters* item.



### Properties module

A certain pattern can be selected with many associated parameters that can be set via the *Property* module:

- *Application* - clicking on the value slot produces a drop-down arrow bringing a list of applications. Choosing the required one sets the subsequent properties.
- *X / Y / Z size* - dimensions of the pattern
- *Scan Direction* -
- *Dwell Time* - a time the beam spends on a single pixel per pass (rounded to a multiple of 25 ns).
- *Time* - required to process this pattern
- *Rotation* of the patterns (the positive direction is clockwise)
- *Position X / Y* of the pattern relative to the origin (the display center)
- *Overlap X / Y* - sets the beam diameter overlap. The value of the overlap can be positive or negative, depending on a particular application. The overlap parameter influences the Area Calculation and the Dose.
- *Gas Type* - the gas to be used to process the pattern (or None if no gas is to be used). This determines the pattern color onscreen.
- *Pitch X / Y* - sets the pitch between two spots
- *Area Calculation* - defines how the patterning area will be calculated in order to get the most accurate value for the *Dose*. This value is related with the Overlap X/Y. The Pattern (default) / Array are set for positive / negative overlaps.
- *Dose* -
- *Volume per Dose* - the volume of material that is removed per charge
- *Saturation Sputter Rate* - the maximum linear sputter rate for a given gas. For Gas = None, this is 0 (actually not used).
- *Refresh Time* - the minimum loop time that must elapse before the next pass, so that the adsorbed gas can be refreshed



- *Loop Time* - the time required for a single pass (read only)
- *Area* - the surface area of the pattern (read only)
- *Scan Type* - *Serpentine* means the beam proceeds from left to right and back from right to left, while *Raster* scans from left to right, then the beam returns to the left starting point
- *Fill Style* - one can choose either to mill a *Solid* or just a *Frame* (box and circular types only)
- *Passes* - a number of the beam scans over the pattern
- *Defocus* of the beam (WD change) - influences the Total Diameter and Area Calculation. It allows focusing above / below (negative / positive value) the sample surface
- *Blur* - like Defocus, but specifying the (additional) diameter of the blurred spot
- *Interaction Diameter* for an infinitely small beam - influences the Total diameter
- *Total Diameter* - the combination of the beam diameter and interaction diameter influences the Overlap X / Y and Pitch X / Y values (read only)
- *Maximum Dose per Area* - describes the adsorbed gas layer, allowing a certain dose to be deposited at a higher rate than the saturation current density, allowing a temporary higher rate (actually not used)
- *Saturation Current Density* - the current at which 63% of the saturation sputter rate is reached (actually not used)
- *Total Volume Sputter Rate* - the speed at which material is removed or deposited (actually not used)

Loop Time	451.9 ms
Area	202.14 $\mu\text{m}^2$
Scan Type	Serpentine ▾
Fill Style	Solid ▾
Passes	1677
Defocus	0 $\mu\text{m}$
Blur	0 $\mu\text{m}$
Interaction Diameter	0 $\mu\text{m}$
Total Diameter	44.0 nm
Maximum Dose per Area	0 nC/ $\mu\text{m}^2$
Saturation Current Density	1.000E-18 A/nm <sup>2</sup>
Total Volume Sputter Rate	2.673E-1 $\mu\text{m}^3/\text{s}$

## Gas Injection module (option)

Patterns have many associated parameters, such as the gas that can optionally be used during patterning to deposit the desired material. The gas is delivered by a Gas Injection System (GIS) on the sample surface.

As different applications require different gases, there can be more GIS's installed on your system. One can select an Application file for a given pattern in the Patterning property editor. It automatically sets the appropriate GIS, the dwell time and overlap and calculates the proper dose appropriate to the beam chemistry. A pattern must be defined before the material file is selected.

The GIS can be selected manually, but note that overlap, dwell time and an appropriate gas type should be set carefully to avoid disappointing results.

### Setting up the GIS

The *Gas Injection* module enables control of the installed GIS's. A Gas type is allocated to each GIS (several injectors may be mounted according to the configuration, its color depends on the gas type). A tooltip info is given about the selected GIS line:

- *Port #* - GIS connection position
- *Lifetime* - time of GIS employment

Right-clicking on the installed GIS module line opens a context menu.

Before patterning with the GIS starts, the gas reservoir must be heated by selecting the *Heat* column context menu / *Warm* item. The *Cold* status is replaced by a progress bar, which in turn is replaced by the *Warm* status when the GIS is fully heated. To cool down a reservoir, proceed in reverse order.

To insert the GIS needle manually, click on the *Insert* check box (a tick mark). A confirmation dialog appears. Clicking on the *Insert* check box again retracts (clear box) the GIS.

Gas Injection ?			
Gas	Insert	Heat	Flow
<input type="radio"/> C dep	<input type="checkbox"/>	Warm	Closed
<input checked="" type="radio"/> Pt dep	<input type="checkbox"/>	Warm	Closed

Gas Injection ?			
Gas	Insert	Heat	Flow
<input type="radio"/> C dep	<input type="checkbox"/>	Warm	Closed
<input checked="" type="radio"/> Pt dep	<input type="checkbox"/>	Warm	Closed

**C dep Info**  
Port 1  
Lifetime: 0.0 hours

Gas Injection ?			
Gas	Insert	Heat	Flow
<input type="radio"/> C dep	<input type="checkbox"/>	Warm	Closed
<input checked="" type="radio"/> Pt dep	<input type="checkbox"/>	Warm	Closed

Warm

Cold

Warm

### Caution!

*Confirm the needle insertion only if you are sure that nothing obstructs its travel.*

*Beware of stage moves while the GIS is inserted! The GIS needle can be damaged by careless stage movements!*

To open / close the GIS valve, click on the *Flow* column / *Closed* / *Open* status. This will not be possible until the *Heat* column / *Warm* status has been reached.

#### Note

*If any Property module / Gas Type is chosen, the opening / closing of GIS valves is done automatically during patterning.*

Some conditions must be fulfilled before insertion is enabled. The user is notified by a tooltip.

When not in use, the GIS should be closed (to save lifetime), cold and retracted. Leaving it closed, heated but retracted is also an option so that reheating is not necessary if it is to be used over several patterns.

Gas Injection ?			
Gas	Insert	Heat	Flow
<input type="radio"/> C dep	<input type="checkbox"/>	Cold	Closed
<input checked="" type="radio"/> W dep	<input type="checkbox"/>	Cold	Closed
<input checked="" type="radio"/> Pt dep	<input checked="" type="checkbox"/>	Warm	Closed

**To open C dep Valve you need:**  
Heater at desired temperature

### Caution!

*Logging off an actual user does not change the conditions of the GIS's.*

*It can be Warm, In and Opened even if the Microscope Control software is closed!*

*When the vacuum status is vented, GIS needles are retracted automatically. Despite that, retract it/them manually before you start any activity inside the chamber (specimen exchange, detector mounting, etc.).*

## Application Files

---

There are several application files delivered with the system that are intended for different uses. Each one incorporates multiple parameters for particular patterning. Some of these application files use GIS's. With multiple GIS's installed on your system, you can select a suitable application file for a given pattern. Processing specific materials without gas can be done by using no application file, or more efficiently with the appropriate scanning conditions using the dedicated Application file for that material. There are pre-defined (non-editable) and user-defined (saved) files.

### Note

*A pattern must be defined before the Application file is selected. The pattern type automatically predetermines the set of possible application files (therefore of gas type).*

*Within the application files compilation, there is the former Si application file with the Volume per Dose value determined in the past, and the Si New application file with values corrected for use with silicon. Be aware of the different results from using these application files!*

## Application Files Editing

A new application file can be created or an actual Application file can be edited in Windows Notepad® in case any parameter of the process is insufficient. Application files (\*.xml extension) are located in the C:\Program Files\Fei\data\patterning application files\ folder.

### Note

*If any Application file is to be changed, we recommend making a copy of the original one. Server restart is necessary after placing a new Application file in the above mentioned folder for it to be functional.*

### Examples

For clear arrangement, there are comment lines within xml files:

- *comment line filter*  
<!-- Application file for milling silicon (Si) without any gas -->

In order to make the application files selection more comprehensible, several filters have been implemented:

- *pattern type filter*  
The system only shows application files that are related to a given pattern type.  
<!-- Optional type, must be "Line, Circle, Rectangle, RCS, Bitmap, StreamFile, Polygon", can be a combination -->  
<PatternType xmlns:dt="urn:schemas-microsoft-com:datatypes" dt:dt="string"> CCS</PatternType>  
Multiple patterns can be designated in a list separated by comas. If the command is left blank, the file is shown for all pattern types.

- *GIS type filter*  
The system only shows application files depending on GIS's installed on the system.

It is possible to edit / add / remove parameters (for instance Refresh Time - for filling vias, Blur - for depositing large areas etc.) if required for certain applications.

- *Volume per Dose variable*  
<VolumePerDose xmlns:dt="urn:schemas-microsoft-com:datatypes" dt:dt="r8">  
0.15e<sup>-9</sup>  
</VolumePerDose>

The Volume per Dose is material dependent. Using any application file for milling different material substrates results in a different Z size. The actual value can be measured and subsequently a new Volume per Dose value can be defined / set.

## Remote Imaging

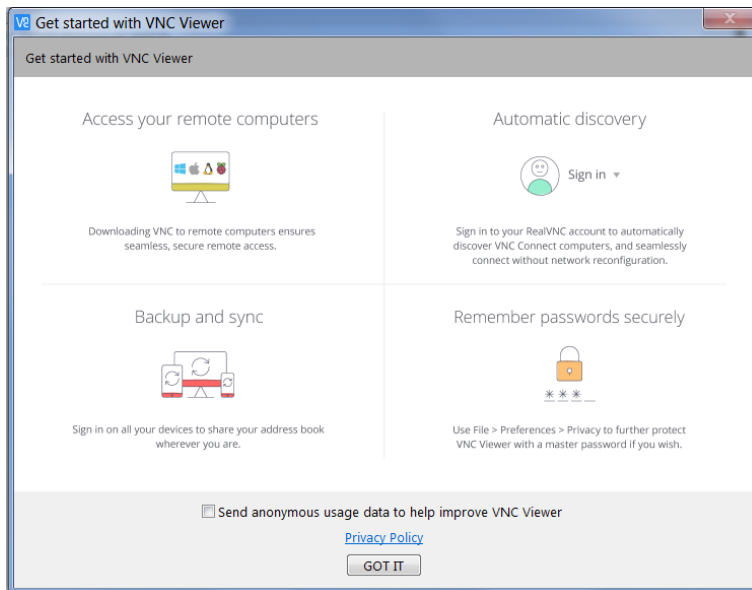
The Remote Imaging enables connection to the Microscope PC via a network using the VNC Connect application and remotely controlling the microscope operation. This application is pre-installed and configured on the Microscope PC and optionally on the Support PC.

For information how to install this functionality, see *Installation Instructions* available on the installation CD. For more details on the remote connection and its possibilities, see *VNC documentation* available on the installation CD.

### Connection to Microscope PC

Follow the steps below to connect to a Microscope PC using DNS or IP address. It is assumed, the VNC Viewer application is downloaded and installed on the remote PC (see the producer's web pages).

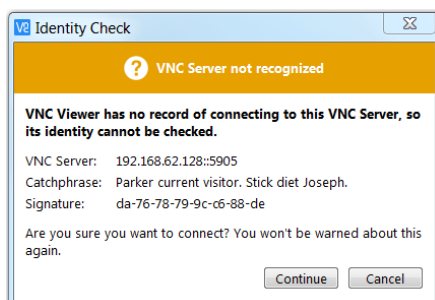
1. Click the *VNC Viewer* icon on the desktop to start the application.
2. Uncheck *Send anonymous usage data to help improve VNC Viewer*.



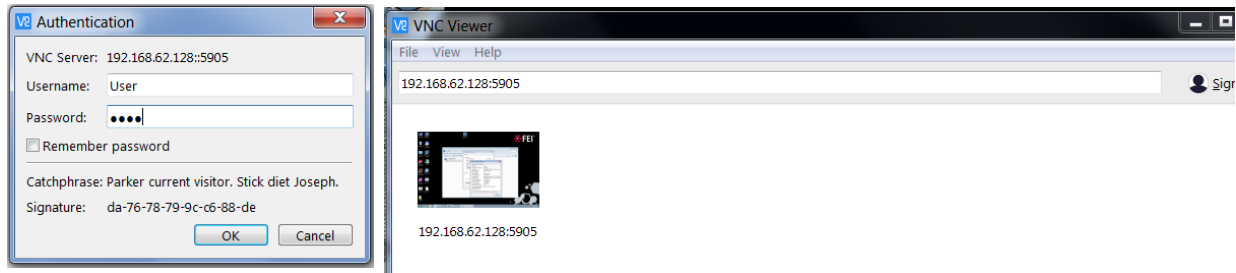
3. Type the appropriate Support PC / Microscope PC name or IP address followed by port number:
  - :5905 for configuration without optional Support PC
  - :5910 for configuration with optional Support PC



4. Press Enter button.
5. Click the *Continue* button in the Identity check dialog.



6. Within the *Authentication* dialog, fill in your microscope *Username*, the corresponding *Password* and click the OK button.



When this step successfully passes, a large window with the remote Microscope PC desktop opens. The set connection is stored within the VNC Viewer as a corresponding icon.

7. To close the remote connection to the Microscope PC, just close the VNC Viewer window.

#### Note

If the VNC viewer reports an error message instead of opening the remote Desktop, check that the VNC Server is running on the Microscope PC, and the *SharedData* folder is accessible from the Microscope PC.

## Microscope PC's Desktop Sharing

Several users can connect to the Microscope PC at the same time and thus share its desktop on the remote PC's. This can be used e.g. for educational purposes. The typical scenario is that a dedicated user/supervisor controls the microscope (locally or remotely): the other connected users can only view the Microscope PC's screen over the network.

1. Open the VNC Viewer application on the remote PC of the person who is to control the microscope and connect remotely to the Microscope PC as a user/supervisor.
2. Other users will then open the VNC Viewer application on their remote PC's and connect remotely as 'view-only' users.

#### Note

Desktop sharing must be enabled in the VNC Server application on the Microscope PC. For instructions on how to do so, see the VNC Server documentation available on the installation CD.

## Controlling Microscope Remotely

When connecting remotely, be aware of the fact that there might be another person operating the microscope locally, i.e. working directly with the Microscope PC.

After connecting remotely to the Microscope PC, you can do all the tasks as if you were working directly with that computer. It is possible to control microscope operation, run the supportive applications, backup or restore user data, view log files, etc.

In general, expect slower response to your commands and actions. This limitation comes from the amount of data that has to be transmitted and from the network bandwidth, especially for network speeds below 10 Mbps.

In case the Microscope Control user interface stops responding or the *Server Busy* dialog appears, the Microscope PC is probably overloaded and may have problems with the actual conditions being operated remotely. If such a problem occurs, wait until the Microscope PC recovers, or restart it, if necessary.

Here are some recommendations for remote control operation:

- To obtain better remote performance, try to use the *View* menu / *Remote Mode* item (see Chapter 3).
- Be very careful when navigating the stage. Always keep in mind that because of delays in imaging data transmission, what you see in the optical display is not the exact position of the stage.
- You can improve the performance / response time by setting the more convenient scanning conditions: the quad image instead of the single image mode, single live display instead of more live displays; lower resolution and slower scan (i.e. higher dwell time).
- Benefit from the automatic functions that are not affected by the delayed response problem (Auto Contrast Brightness, Auto Focus, Auto Stigmator). In case you prefer to focus or correct astigmatism manually, it is better to do so in a reduced area.



## Quick Loader

The Quick Loader was designed for:

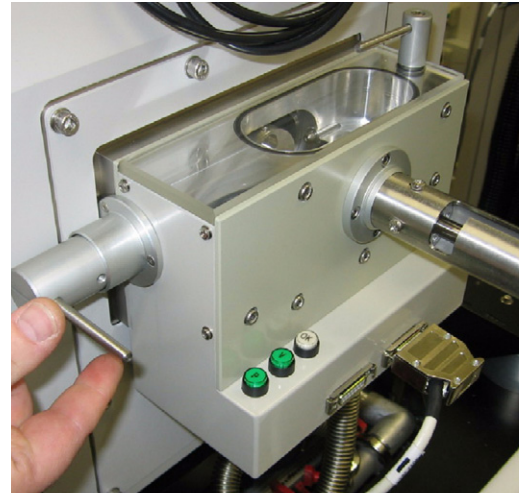
- Easy Sample transfer
- Faster sample through-put
- Contamination free chamber environment
- Materials applications

### Caution!

*Minimize Quick Loader usage with the CryoCleaner (see further) filled with LN<sub>2</sub>!*

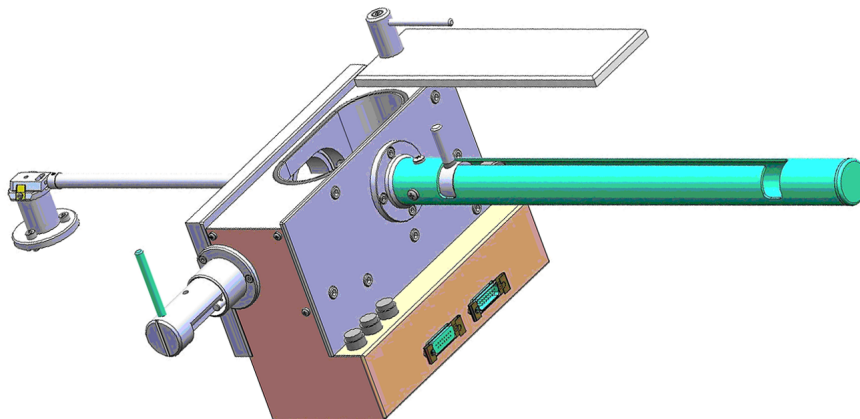
*We strongly recommend venting the specimen chamber and replacing the Nitrogen Vessel with a clean one after completing about 20 subsequent Load cycles with the cool CryoCleaner!*

*This is because each Load cycle adds a small layer of gas and ice onto the Nitrogen Vessel surface, decreasing the CryoCleaner's efficiency and increasing the amount of gas released into the specimen chamber in case the LN<sub>2</sub> dries out.*



## Description

The loader module can manually load and unload small samples into the SDB / SEM. The loader module is connected to the specimen chamber of the SDB / SEM and it has its own pumping system.

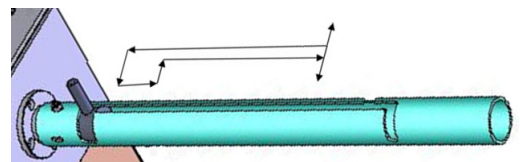


The loader consists of a loading rod with set slide and parking positions and a loader chamber for loading and unloading the sample carrier (with sample) onto a bayonet fitting located at the end of the rod. A gate valve seals the vacuum of the SDB / SEM specimen chamber and can only be opened when the vacuum of the loader chamber is correct. This is indicated by the OK labeled LED, which is prompted by an electrical and mechanical interlock.

The sample carrier can be entered into the main SDB / SEM specimen chamber by way of the rod and released by the rotating motion of the rod at a predetermined position on the stage adapter.

### Loading Rod

The loading rod has a pre-machined slot to move in to load or unload a sample. At each end there is a side slot. There are 2 side slots at the further end from the vacuum chamber. One is for loading and unloading the sample carrier in the loader chamber; the other is a parking position (prevents the rod from being sucked in by the vacuum).



### Caution!

*Do not unload the sample carrier with the gate valve opened! The sample carrier can drop down from the rod.*

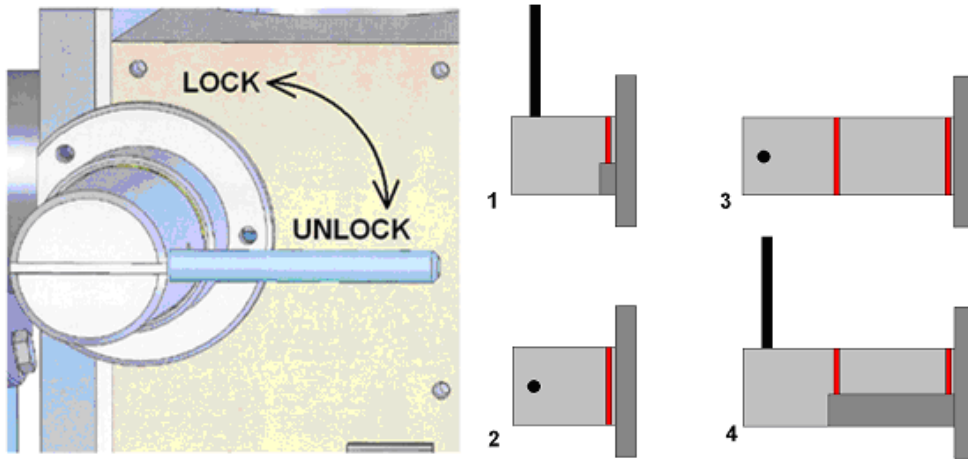
At the end of the rod closest to the loader chamber is a large slot for coupling and de-coupling the bayonet into or out of the sample carrier when positioned on the carrier adapter.

The bayonet is designed to make a positive and secure connection to the sample carrier so that it remains horizontal and in a straight line to connect with the carrier adapter within the specimen chamber.

## Gate Valve

The Gate Valve has positions that are defined by the following statuses:

- rotated position of the Gate Valve Lever - LOCK / UNLOCK  
The position has to be turned from LOCK to UNLOCK to be able to move the loading rod IN and OUT
- colored strips on the side of the exposed barrel axis - one / two when IN / OUT



- Position 1 - IN and LOCK
- Position 2 - IN and UNLOCK
- Position 3 - OUT and UNLOCK
- Position 4 - OUT and LOCK (prevents vacuum closing valve).

The Gate Valve has two safety movements.

- it can be placed over the entry hole on the slide
- it can be locked in place by a turn of the connecting knob (securing the closure of the valve)

A system interlock takes care of correct conditions (system vacuum, accelerating voltage) for loading and unloading cycles (movement of the gate valve).

## Controls

There are 2 buttons (illuminated while in operation) and 1 indicator lamp:

- P* (pump) labeled button - press it to pump the loader chamber to the required vacuum; the stage moves to a loading position at the same time. If the system reaches the appropriate vacuum level, the lever interlock is released and the gate valve can be opened. The pump cycle is automatically terminated when the required vacuum is reached.
- V* (vent) labeled button - press it once to vent the loader chamber. The vent cycle continues until the *P* button is pressed or it is terminated by a time-out.
- OK* labeled indicator lamp - lights up when vacuum is reached after pumping. When it goes out, this means the wait time has been exceeded and the appropriate vacuum for a transfer has been lost. Pressing the *P* button again will bring the system to vacuum OK status.

The control buttons do not shine when the system is recovering from vacuum status transition (e.g. immediately after the load/unload sample, during venting the chamber...). After finishing the state transition, the control buttons will again be in operation.

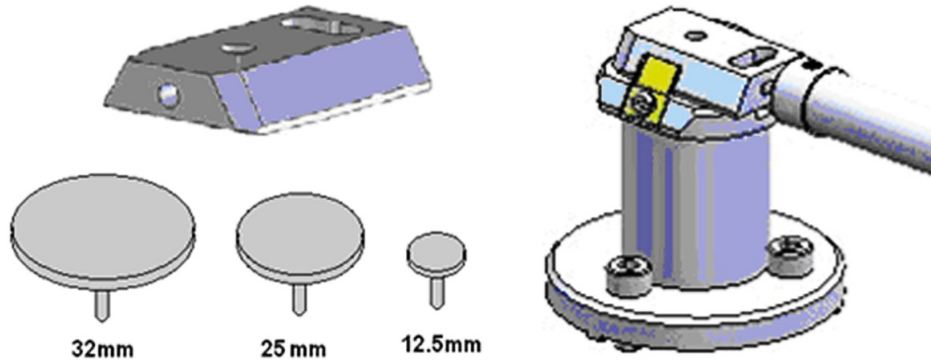
## Sample Carrier and Stage Adapter

A sample carrier (2 pcs.) is used to hold and transport the sample from the loader to the specimen stage of the SDB / SEM. The carrier sits in the stage adapter with a dovetail joint. It is fixed to the loading rod via a bayonet coupling. The loading rod is de-coupled at the bayonet coupling when the sample carrier is located in the adapter and withdrawn, leaving the sample carrier ready for sample observation.

The Stage Adapter is connected to the rotation base of the stage by 3 hexagonal headed screws. The base of the adapter has 3 high points for a firm 3-point contact to the rotation base to prevent vibration transmission.

The height of the stage adapter is distinct to the SDB /SEM system it is used with. The top of the adapter has a dovetail slot for the acceptance of the sample carrier from the rod loading mechanism.

**FIGURE 7-7:** *Sample Carrier / Stage Adapter*

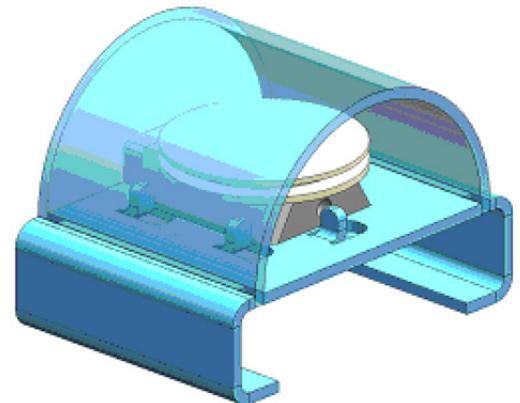


## Sample Gauge

Before mounting the Stage Adapter, the stage must be homed with the chamber door opened.

Only samples that fit the Sample Gauge can be loaded. One sample stub with a diameter up to 32 mm (1 1/4") can be used, although standard sizes of 25 mm and 12.5 mm can also be used. Height can be no greater than 9 mm.

The shuttle clamps with a spring in the dovetail shaped slot of the adapter. It is fixed to the loader arm via a bayonet coupling. The maximum pin length of the stubs that can be used is 11 mm (most common commercial type stubs have a pin length no greater than 8 mm).



## Installation

The Quick Loader is pre-installed in the factory. No special adjustment is needed only the loading rod is not installed for transport.

1. Unpack the lead glass lid.
2. Remove four screws holding the cover of the loading rod feedthrough.
3. Use the same screws to attach the loading rod to the loader chamber.

## Loading position

The load / unload position is factory preset. If calibration is needed, run the *Quick Loader Alignments* first.

The image displays two screenshots of the 'Alignments' software window. The left screenshot shows the 'Alignments' window with a dropdown menu set to 'Quick Loader Alignments'. Below the dropdown, the 'QuickLoaderAlignments' menu item is highlighted, and the 'QuickLoaderAlignment' sub-item is also highlighted. A 'Finish' button is visible at the bottom right of the window.

The right screenshot shows the 'Alignments' window with the 'Quick Loader Alignment' sub-item selected. The main content area contains the following text:

[This alignment procedure is used to define Quick Loader exchange position(x, y, z, r, t)]

1. Set tilt to zero degrees.
2. Vent specimen chamber, open the door and home the stage.
3. Adjust rotation axis so that the dovetail joint of the adapter is parallel with Y axis of the stage, and the stop-pin is on the left. Write down adjusted rotation position.
4. Close the door, pump specimen chamber and pump the quick loader. Open the gate valve, set rotation to previously found position and insert transfer rod with the shuttle.
5. Adjust X, Y and Z to find the optimum exchange position
6. Retract the rod and close the gate valve
7. Press the Finish button to set the exchange position or press Cancel to restore previous exchange position.

At the bottom of the window, a table displays the current coordinates:

X:	0.0000 mm
Y:	0.0000 mm
Z:	0.0000 mm
R:	0.0 °
T:	0.0 °



## Operations

---

### Loading a sample

1. Mount the sample with fast drying adhesive medium onto the stub. Allow to dry.
2. Check the sample satisfies the sample limits imposed by placing the top of the mounting tool over the base mount.

### Caution!

*If the sample proves to be too large, this has to be addressed before the sample and carrier are allowed into the loader chamber.*

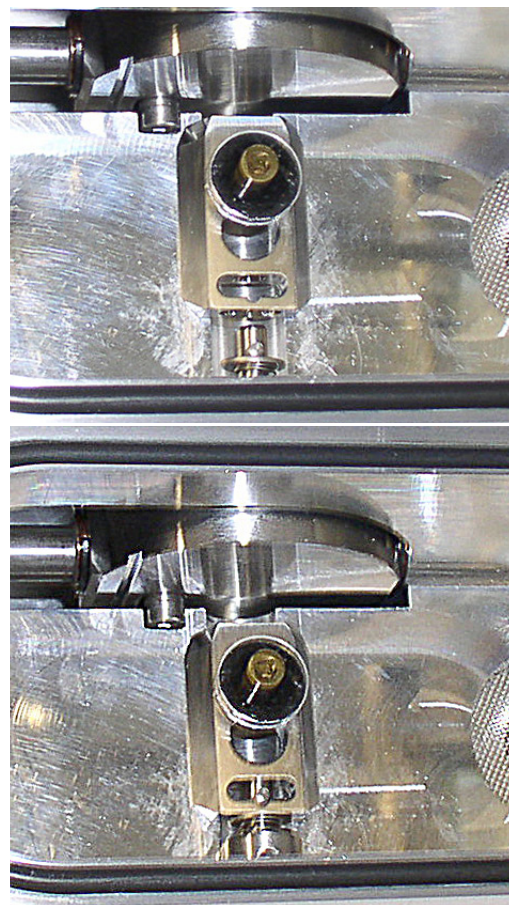
3. If the sample satisfies the limits, the sample-loaded carrier can be loaded into the loader chamber. A user can either remove from or place a mounted carrier in the loader chamber by using tweezers for stubs that will fit around the stub rim.

#### Note

*Loading samples this way is easier and safer than trying to mount the sample directly into the sample carrier while it is in the loader chamber.*

### Rod Loading Sequence

1. While holding the sample carrier on the loading table in the loader chamber, move the rod out of the Parking position to the far left, to the back of the slot, and forward to engage the bayonet into the sample carrier. Place the rod into the Parking position after coupling to prevent the rod from slowly creeping forwards.
2. Switch off the electron beam accelerating voltage. Retract the GIS modules and STEM detector (if present) to a safe state (cannot be used in combination with the loader).
3. Close the loader chamber lid. After the lid is properly closed the *P* button starts to shine.
4. Press the *P* button. The button stops shining and the pumping cycle starts. The stage moves to the loading position at the same time. When the vacuum in the loader chamber is correct, the pump light starts to shine and the *OK* button lights up, indicating operation can continue. The gate valve lever interlock is released.
5. Turn the Gate Valve knob lever from LOCK to UNLOCK position. Then carefully pull the knob bar fully out from the first mark on the knob drum to the second mark. Turn the knob bar counterclockwise to the LOCK position.
6. Move the loading rod from the Parking position into the chamber while still holding the rod bar. The Sample Carrier will engage with the Stage Adapter at the end of the rod travel.
7. Turn the rod bar to the left (counterclockwise) to the base of the slot. Pull back on the rod bar so it travels along the base of the slot, then turn it to the right (clockwise) so that the rod bar is vertical, and withdraw it back to the PARK slot at the far end of the rod guide.
8. Close the Gate Valve by turning the knob bar to the UNLOCK position and press the knob in to engage the valve over the opening. This can be seen through the lead glass lid. Then turn the knob bar to the LOCK position to secure the valve. Good practice is to leave the loader chamber under vacuum.



## Unloading a sample

1. If there is a sample carrier in the loader chamber attached to the bayonet, remove it (the chamber needs to be vented and the carrier removed).
2. Switch off the electron beam accelerating voltage. Retract the GIS modules or STEM detector (if present) to a safe state (cannot be used in combination with the loader).
3. Close the loader chamber lid. After the lid is properly closed, the *P* button starts to shine.
4. Press the *P* button. The button stops shining and the pumping cycle starts. The stage moves to the loading position at the same time. When the vacuum in the loader chamber is correct, the pump light starts to shine and the *OK* button lights up, indicating operation can continue. The gate valve lever interlock is released.
5. Turn the Gate Valve knob lever from the LOCK to the UNLOCK position. Then carefully pull the knob bar fully out from the first mark on the knob drum to the second mark. Turn the knob bar counterclockwise to the LOCK position.
6. Move the unloading rod from the Parking position into the chamber while still holding the rod bar. When resistance is found, turn the rod bar to the left (counterclockwise) to enter the bayonet. Push forward and turn the rod to the right (clockwise). The bayonet will engage with the Sample Carrier on the Stage Adapter close to the end of the rod travel.
7. Withdraw the rod back to the far end of the rod guide and place it in the Parking position. The rod, bayonet and sample carrier are now out of the specimen chamber and sit in the Loader chamber.
8. Close the Gate Valve by turning the knob bar to the UNLOCK position. Press the knob in to engage the valve over the opening. This can be seen through the lead glass lid. Then turn the knob bar to the LOCK position to secure the valve.
9. Press the *V* button once. The loader chamber will be vented and the lid can be opened. The sample carrier can be released by turning the rod bar to the far left and pulled back, then returned to the parking position. Remove the sample carrier.
10. Close the loader chamber lid.
11. Press the *P* button to evacuate the loader chamber.

### Note

*In case the sample carrier falls from the loading rod, vent the specimen / loader chamber with gate valve opened, put the carrier back to its correct position, and close the gate valve. Proceed from step 1.*

## UMB Stub Holder Kit

---

This option contains the following items:

- Universal mounting base (UMB)
- Storage box
- 2 stub modules each holding 3× 1/2" stubs or 2× 1" stubs
- 2 clamp bars
- User guide
- System calibration sample

The stub holder is mounted on the stage interface plate.

## CryoCleanerEC

This equipment allows decreased contamination levels in the system. The CryoCleanerEC can be efficient to approximately 24 hours (CryoCleaner – older version – has silver plated Dewar vessel and can be efficient to about 10 hours).

### WARNING!

*This option uses liquid Nitrogen (LN2), which may cause serious cold burns.*

## Parts and Accessories

The CryoCleanerEC consists of a Nitrogen vessel that is surrounded by an outer container, the Vacuum vessel, which is connected to one of the specimen chamber ports by a vacuum seal. The space between is then pumped by the microscope vacuum system.

When the specimen chamber (together with the CryoCleaner) is pumped, liquid Nitrogen is introduced into the Nitrogen vessel.

Its outside cold surface adsorbs contaminating products from the specimen chamber. The vacuum in the specimen chamber improves over a short period, and contamination is now reduced.

The Vacuum vessel has a special flange enabling mounting it to different chamber ports with the use of an interlink with the desired shape (depending on the port to be used and its vicinity).

The interlink flanges can be mounted by means of the 3 screw-hole fittings on the perimeter of the vacuum flange. Care must be taken that the 'O' ring held in the end of the flange is secure, free of dirt and is not crimped when mounting.



**FIGURE 7-8:** Vacuum Vessel and Nitrogen Vessel with accessories / Flanges





## CryoCleaner Operation

Once mounted, the Nitrogen vessel can be placed in the Vacuum vessel. Secure the two components by fixing the clips to the top of the Nitrogen vessel and locking the clips down. Take care that the 'O' ring seal on the Vacuum vessel is secure when joining the two components together.

### Dewar Vessel Refilling

#### **WARNING!**

*The handling of LN2 should be performed wearing face and hand protection in the form of a face visor and a pair of thermal protective gloves.*

*Users must not touch the cold surfaces of the Dewar, as this can result in burns. Use the Safety pliers provided when handling the Nitrogen Vessel.*

1. Pump the specimen chamber. The Vacuum vessel is pumped along with it.
2. When the specimen chamber vacuum is ready (Pumped status), partially fill the Dewar, using the funnel (the plastic cap upside down). Wait until boiling stops.
3. Then fill the Dewar and place the plastic cap at the top of the CryoCleaner. The volume of liquid Nitrogen needed is approximately 500 ml.

#### Note

*The LN2 stops boiling very quickly so that no vibration is seen from this device. If the CryoCleaner needs to be used for longer periods, it can be refilled with LN2.*

*Before re-filling it, vessel baking is recommended.*

**FIGURE 7-9:** Plastic Cap Filling Position / Plastic Cap Operation Position



### Removing Nitrogen Vessel

#### **WARNING!**

*Use the Safety pliers provided when handling the Nitrogen vessel.*

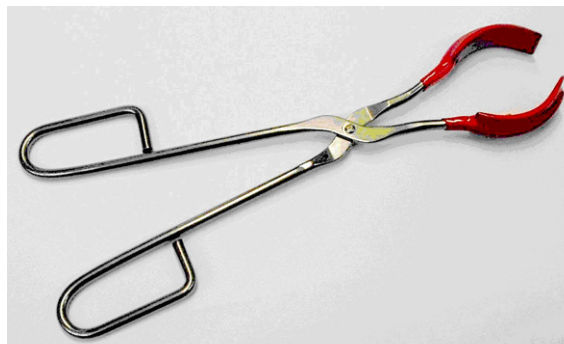
Removing the Nitrogen vessel depends on the level of contamination found in the specimen chamber. If the level is unusually high, then the CryoCleaner can work continuously till improvement is seen. Otherwise, normally after approximately 2 to 3 hours, the Nitrogen vessel can be removed.

#### Note

*We recommend not leaving it inside the vacuum vessel after all the nitrogen has evaporated, because contamination evaporates back into the chamber.*

*If the chamber is vented with the Nitrogen vessel filled with LN2 (or still significantly below the ambient temperature), it should be removed and baked before it is re-used.*

1. Vent the specimen chamber (the excess LN2 starts to boil).
2. Unclip the Nitrogen vessel from the Vacuum vessel. Lift the Nitrogen vessel out of the Vacuum vessel by the Safety pliers placed under the ring on the neck of the Dewar cylinder.
3. Place the Lid over the Vacuum vessel to seal it from the atmosphere (fix the clips). Pump the specimen chamber again. The microscope vacuum remains cleaner than before, and sample contamination is still reduced.
4. Remove the cap from the Nitrogen vessel and pour out the excess LN2 into a suitable container.



## **WARNING!**

*When the LN2 is removed from the nitrogen vessel, the bottle still remains at a very low temperature!*

### **Baking Vessel**

1. Place the Nitrogen vessel onto the stand ready for baking.
2. Place the vessel stand on a suitable heat-resistant surface.
3. Place the vessel onto it and use an Infra-red lamp to bake the base of the bottle. Baking should take place for approximately 2 hours.  
Alternatively, the vessel can be baked in an oven at 90 °C for 2 hours.
4. Allow the vessel to cool down before handling!

Regenerating the Dewar by heat allows removal of condensed contamination and subsequent reuse of the vessel.

#### *Note*

*The oven that is used must have a venting system to extract any harmful fumes. Alternatively, it should be baked in a fume cupboard using an infra-red lamp.*

### **Replacing Vessel**

1. Allow the vessel to cool down before handling!
2. Vent the specimen chamber.
3. Unlock two clips holding the Vacuum vessel lid. Remove the lid from the Vacuum vessel.
4. The Nitrogen vessel can be placed in the Vacuum vessel, taking care that the 'O' ring seal on the Vacuum vessel is secure when joining the two components together. Secure the two components by fixing the clips to the top of the Nitrogen vessel and locking the clips down.
5. Pump the specimen chamber. The Vacuum vessel is pumped along with the specimen chamber.

### **Maintenance**

---

- Keep the 'O' rings clean of dust and fiber particles by inspecting the Vacuum vessel main 'O' ring on a regular basis. If the Vacuum vessel is removed frequently from the specimen chamber, inspect the specimen chamber 'O' ring seal each time.
- Keep the sealing surfaces of the Nitrogen vessel and the Vacuum vessel lid clean and free of dust and fiber particles.
- Do not use any kind of vacuum grease on the 'O' rings.
- Wipe the outsides of the stainless steel parts to remove fingerprint stains with a lint-free cloth dampened with a neutral pH soap solution.

### **Spare Vessel**

---

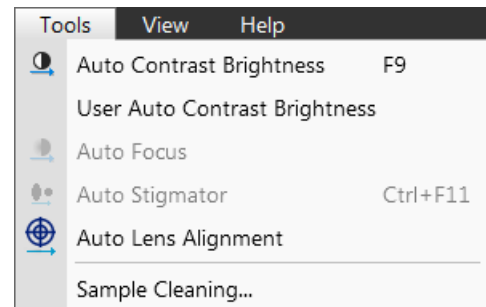
It is possible to obtain a secondary nitrogen vessel kit, which contains:

- Nitrogen Vessel
- Vessel Stand
- Vessel Plug

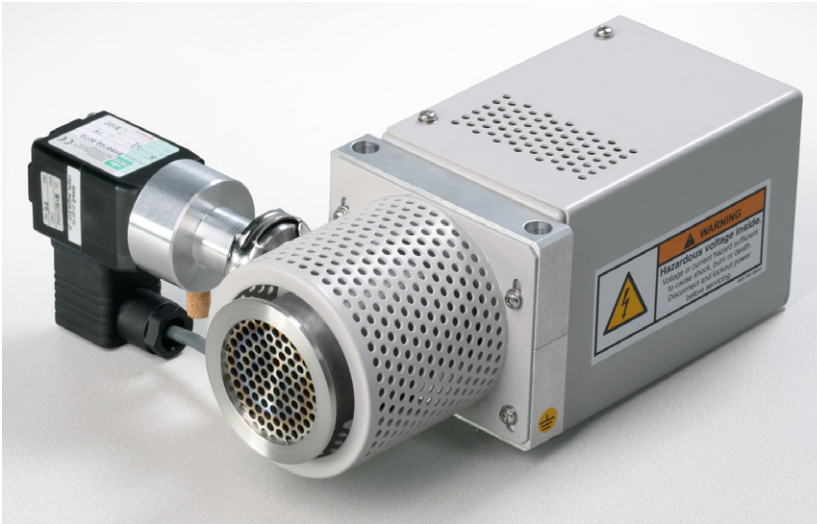
# Plasma Cleaner

The *Tools* menu / *Sample Cleaning* item starts the Sample Cleaning procedure, which is an efficient process for removing very thin contamination layers, that are typically formed by hydrocarbon residues remaining on vacuum parts after conventional cleaning or that could have been transferred into the microscope chamber by a sample.

The plasma cleaner generates free oxygen radicals, that react with hydrocarbon molecules on the surfaces to form CO, CO<sub>2</sub>, and H<sub>2</sub>O molecules that can be pumped away. It is operated at special vacuum conditions (~50 Pa) similar to the Low Vacuum mode.



**FIGURE 7-10:** *Plasma Cleaner*



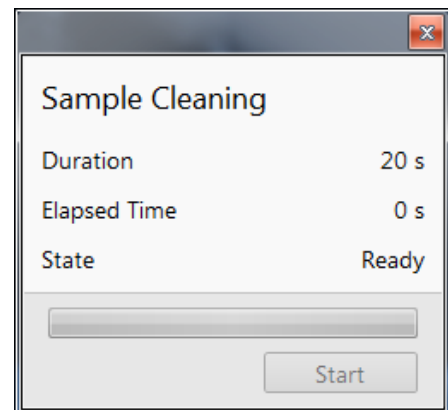
The Sample Cleaning procedure uses settings from the *Plasma Cleaning Alignment* (see Chapter 4).

For avoiding typical “weak” contamination artifacts during high resolution imaging (image darkening), 1-2 minutes of plasma cleaning in combination with cryo cleaning should be sufficient. When bulky deposition is visible (mostly on image corners), 5 minutes of plasma cleaning is recommended.

### Note

*Porous, biological or hydrocarbon based samples cannot typically be viewed without the presence of contamination artifacts that are caused by presence of contamination sources within the sample itself even after plasma cleaning.*

*Sometimes, poor image quality can also be caused by e-beam etching and re-deposition of etched material.*



### Caution!

*Using the Plasma Cleaner is not recommended when the VolumeScope ultramicrotome is mounted inside the microscope chamber!*

*Remove the VS DBS detector from the chamber (parking position) when the Plasma Cleaner is going to be used!*

### WARNING!

*If the EDS / WDS / EBSD system is mounted, use a 1 mm collimator on the EDS detector and do not exceed 5 minutes overall procedure duration once a day at most.*

*Always retract the EDS detector before plasma cleaning!*

*Avoid leaving sensitive carbon-containing samples (e.g. photo resist) inside the chamber during the Plasma Cleaning procedure, as they may be etched by the cleaning process.*

*Any material that can create or release oxide easily (e.g. silver) should not be plasma cleaned.*

*Only the Au-C resolution tests samples can be left inside the chamber during the Sample Cleaning procedure, but not very often!*

## Sample Cleaning Procedure

---

1. Move the stage to the lowest Z-axis position and tilt it to zero.  
This is to avoid any possible shadowing effect by the column if the sample is at a short working distance.
2. Run the *Tools* menu / *Sample Cleaning* procedure.  
It is also possible to enter the procedure from the vented state by using the *Sample Exchange* window. While the procedure is in progress, stage moves are disabled temporarily.  
When the procedure is finished or aborted by a user, the system remains pumped.
3. Move stage back to the observation position.

When starting the procedure, some conditions are not allowed. In these cases, a dialog or tooltip appears onscreen.

Sample Cleaning cannot be started when chamber is being pumped or vented.

When Plasma Cleaning is started from the LoVac mode, the chamber is partly pumped to a lower pressure. The user is asked to confirm this action before Plasma Cleaning is started.

### Note

*When one is going to observe in LoVac immediately after plasma cleaning with a different gaseous environment, we advise running the Purging procedure (see Chapter 3). 4*

## Chamber Cleaning

---

To periodically clean the whole system (due to build-ups from samples, carriers, service events, etc.), use the Chamber Cleaning procedure from the *Plasma Cleaning Alignment*. The clean chamber environment enables an operator to use the system at a level of cleanliness suitable for high-resolution imaging and analysis.

### **Caution!**

*Never use Plasma Cleaner for Chamber Cleaning with CryoCleaner filled with LN2!*

### **WARNING!**

*Do not exceed 30 minutes of chamber cleaning once a week at most when the DBS detector is installed.*

